



Table Solutions+ | Price Guide 2023



Tables | Accompanying Components





- Terms & Conditions 2
- Accessories 4
- Power / Data Solutions 5
- Finish Specifications 9
- Shipping Specifications 10
- Spanner Tops 11

TABLES

- DC**
 - Café / Meeting..... 13
 - Classroom / Training..... 14
 - Conference 16
 - Occasional 20
- DC XL**..... 21
- SLALOM**
 - Café / Meeting..... 46
 - Classroom / Training..... 47
 - Conference 49
 - Occasional 50
- SLALOM XL**..... 51
- PANEL BASE**
 - Conference 76
- STUDIO**
 - Conference / Tech 82
- MADISON**
 - Café / Meeting..... 88
 - Classroom / Training..... 89
 - Conference 92
- JEFFERSON**
 - Café / Meeting..... 97
 - Conference 100
 - Occasional 106

- ALPINE**
 - Training 109

- WOODWARD**
 - Café / Meeting..... 112
 - Training 113

- CAP**
 - Conference 117

- OCCASIONAL TABLES**
 - Parsons..... 124
 - Balance 125
 - Cube..... 126
 - Tapered Cube 127
 - Panel End 128
 - Metal Leg 129

- HUDSON**..... 130

- VIEWPOINT** 136

- COMMUTER** 156

CONFERENCE COMPONENTS

- Credenzas 158
- Lecterns..... 165
- Carts 166
- Phone Stands..... 166



CONTACT INFORMATION:

Primeway Inc.
4250 Normandy Court
Royal Oak, MI 48073

Phone: 248-583-6922
E-mail: customerservice@primewayinc.com
Website: www.primewayinc.com

AUTHORIZATION OF USE:

This catalog is intended for the exclusive use by members of the furniture dealer, architect, and design trades. It is not intended for private use by other than members of the trade such as end users. *Primeway* reserves the right to distribute this catalog to those members of the trade whom they feel conduct themselves and promote *Primeway* products with the highest regard for ethics and professionalism. Distribution of this price guide does not itself constitute an offer to sell.

Use of this catalog represents agreement to the terms and conditions stated herein.

PRICING:

All catalog prices reflect the "List Price" (suggested retail) for shipments within designated areas of the continental United States. Authorized dealers may check with the factory for their assigned discount structure. Prices are subject to change without notice. Pricing on orders are accepted at the prevailing prices in effect at the time the order is placed with the factory assuming ship date is within 90 days of order placement. All prices are stated in U.S. Dollars. Orders can only be placed by authorized *Primeway* Dealers. Additional energy surcharges may apply.

TAXES:

Prices that are listed in this book are exclusive of any sales, use, excise tax or other taxes. It is the dealer/purchaser's responsibility to collect taxes applicable to the sale of these goods to the end user. A dealer's tax exemption certificate is required to be on file at *Primeway* prior to order placement.

QUOTATIONS:

Quotations will typically reflect the Dealer's Net pricing. It is the client's responsibility to review the quote thoroughly to verify that all details as well as pricing is clear before quoting their customer. Pricing is F.O.B. *Primeway* dock in Madison Heights, Michigan, USA. Reference the "Zone Shipping Map" for information regarding freight zone charges. Specify any special shipping requirements when requesting quotations. Additional charges may apply.

ORDER PLACEMENT:

Orders may be submitted via fax, e-mail or regular mail. Verbal orders will not be accepted. Orders will be accepted subject to the client's credit status at the time of ordering. Acceptance of orders by *Primeway, Inc.* is strictly based upon the terms and conditions stated herein and supersede any conditions noted on client's order. To insure prompt delivery, all orders must satisfy the following criteria:

- Supply a valid purchase order with the P.O. number on each page.
- Current billing address.
- All applicable shipping information.
- Special shipping instructions, if any.
- Supply the complete model number which will include:
 - Primary model number
 - Edge style code
 - Worksurface finish code
 - Worksurface edge finish code
 - Base color finish code
 - Any applicable option codes

Large volume orders may require a deposit to begin production.

CANCELLATIONS:

All products are made to order. Cancellations or changes to the order will only be accepted prior to entering production. Should a cancellation or change occur, the client will be responsible for any and all costs incurred by the factory as a result of the cancellation or change in the order. No cancellations or changes will be accepted once the order has entered production.

ACKNOWLEDGMENTS / LEAD-TIMES:

Upon receipt of an order with all necessary information, it is the policy of *Primeway* to provide a written "Acknowledgment". The acknowledgment will reflect the estimated completion date, the correct Net Pricing and could also reflect additional charges that may apply such as shipping or crating costs. It is the responsibility of the client to review the acknowledgment immediately upon receipt for any discrepancies that may occur and notify the factory at once. When calling the factory regarding an order, please refer to the acknowledgment number assigned to your order. *Primeway* will always make every effort to adhere to requested lead-times and to comply with lead-times assigned to acknowledged orders. However, the lead-time assigned to your order is an estimate only and cannot be considered a guaranteed delivery date or terms of agreement. Delays in shipment do not constitute a valid reason for cancellation or an extension of terms upon shipment. *Primeway* is not liable for costs incurred by their clients or the end user caused by delays in delivery or failure to deliver which may result from circumstances beyond our reasonable control.

SHIPPING / ROUTING:

Unless specific shipping and/or routing requests are made by the client at time of order placement, *Primeway* will use its best judgment in selecting carriers and routes in an attempt to provide the best/most economical method of shipment. *Primeway* is not responsible for delays in transit or damages incurred by the carrier. Pricing includes all applicable packaging / crating suitable for shipment. *Primeway* reserves the right to package finished goods in a manner that best suits the shipping conditions. Shipment of orders are to a single location and ship complete. Split orders by the customer will result in additional charges.

See Shipping Map for freight charges.

PACKAGING / ASSEMBLY:

Primeway, Inc. has the utmost concern for the health and safety of your delivery and installation team. Large, heavy products can be dangerous to move long distances. Some products ship assembled and some may require minor assembly due to the overall size of finished goods. Consult the factory for details on shipping methods. It is recommended that items shipped unassembled be assembled at their final destination to avoid injury to a worker or damage to the product.

Primeway is environmentally responsible. Our packaging methods have been designed to minimize waste and reduce installation time. Most products are packaged using materials made with high recycled content. Packaging consists of shrink wrap and cardboard protectors and is palletized when applicable.

CLAIMS / SHORTAGE:

Please take time to check merchandise immediately upon receiving, for any visual or concealed defects.

It is the responsibility of the client, not necessarily the consignee, to notify the factory in writing within 48 hours of receipt of the merchandise of any factory defects, shortages or errors that may have occurred.

It is the responsibility of the consignee, by law, to examine the merchandise upon receipt, note damages on the carrier's bill of lading and file damage claims. In the event of damage, all parts, pieces and crating / packaging materials should be retained until the proper inspections have been made. *Primeway, Inc.* is not responsible for merchandise once it is received in good condition by the carrier.

Clients desiring a drop shipment to other than their normal receiving location should consult the factory for details and possible charges which may result. When drop shipments are necessary, the client should make arrangements with the consignee to properly receive the goods and forward them to their final destination. These arrangements can usually be made with a transfer agent or network dealer in the destination area.

SPECIAL HANDLING:

Charges for the expediting of shipments will not be incurred by *Primeway*. Should shipments be delayed by the client, *Primeway* reserves the right to place the merchandise in storage at the client's expense and will not be held liable for these goods. Payment terms will begin upon notice to the client that the merchandise is ready for delivery or pick up.

RETURNS:

No returned merchandise will be accepted without prior written authorization from the factory. An RGA (Returned Goods Authorization) form will be provided. All products are made to order, therefore, no allowances will be extended for merchandise returned for restocking. Restocking charges may apply. No freight collect shipments will be accepted.

PAYMENT TERMS:

All new clients of *Primeway, Inc.* will be required to provide a completed *Primeway* credit application as well as a tax exemption certificate where applicable. Those in good credit standing will be placed on an open account basis with terms of 1% 10 days / Net 30. These terms will be strictly enforced. Accounts not paying within the assigned terms will be placed in delinquent status and all orders will be held until matters can be rectified. *Primeway* reserves the right to change or cancel assigned terms and credit at any time. All new accounts may be required to provide a 50% deposit or Pro-Forma payment prior to order processing. A client inactive for six months or more may be required to provide current credit information and/or payment along with placement of an order. Use of this catalog represents agreement that *Primeway* has the right to enforce a late fee of 1.5% per month (18% per year) on invoices unpaid beyond 30 days from invoice date.

Products sold by *Primeway, Inc.* shall remain the personal property of *Primeway, Inc.* until paid in full.



GENERAL SPECIFICATIONS:

Primeway makes every attempt to adhere as closely as possible to sizes and specifications noted herein. However, all sizes shall be considered nominal with a plus or minus factor of 1/2".

Primeway, Inc. reserves the right to discontinue catalog items or any other goods and services without prior notice. In a continuing effort to improve the quality of our products, it is the unconditional right of Primeway, Inc. to make changes in construction methods and/or materials without prior notice. Specifications on the product listed within this catalog represents the size, style, methods and material in use at the time of catalog publication.

GENERAL CARE AND MAINTENANCE:

Laminate surfaces are highly durable. However, care should be taken to ensure years of dependable service. Objects placed on laminate surfaces should have felt or cork pads on the bottom to avoid scratches. For care and maintenance of laminated surfaces, refer to the guidelines below.

- Clean all surfaces frequently with a mild soap solution and a soft cloth moving the cloth in the direction of the grain. Follow up with a dry soft cloth.
- Avoid over exposing the furniture to direct sunlight. Sun-rays may cause excessive heat build up on dark laminate surfaces.

LIMITED LIFETIME WARRANTY:

The factory warrants its merchandise to be free of defects in materials and workmanship for the life of the product from the date of the original invoice and to the original customer, assuming normal use and care of the product. Normal use means by one individual (single shift) in a standard 40 hour work week. Defects such as scratches, cracks or chips will be repaired or replaced at no cost only if the factory is notified of these defects within 48 hours of receipt of delivery from the factory.

Warranty Exceptions:

- TFL (Thermally Fused Laminate) finishes: 25 Year Warranty
- HPL (High Pressure Laminate) finishes: 10 Year Warranty
- Metal Bases: 5 Year Limited Warranty
- Power/Data, Lighting and other Electrical Components: 1 Year Warranty

WARRANTY EXCLUSIONS:

Warranty does not apply to light bulbs, ballasts or Customers Own Materials (C.O.M). Warranty does not include the matching of grain, texture or dye lots on warranty replacement parts to the original components. All furniture is subject to environmental conditions. In particular, sustained relative humidity lower than 60% may cause products or finishes to begin cracking and may cause doors or independent panels to bow. Warranty does not apply to products subjected to extreme cold or hot and conditions of excessively high or low humidity. Warranty does not apply to normal wear and tear, damage caused by misuse, accidents, negligence or abuse, products incorrectly assembled or installed.

Warranty is void if the product is modified or altered in any way by other than Primeway, Inc. Prolonged exposure to direct sunlight or intense heat such as a radiator may reactivate glue and cause delamination or alter the color of finishes. Warranty does not apply to colorfastness. Absorption of standing water may cause swelling to the substrate and will void the warranty. Primeway is unable to accept responsibilities for these and other environmental conditions. This merchandise is specifically designed and intended for interior use. Warranty does not apply to products used for rental purposes. Warranty applies to goods sold and used within the United States of America.

WARRANTY CLAIMS:

Should a potential warranty situation occur, please contact Primeway with the original acknowledgment number, purchase order number, date of purchase, and product description. Primeway will forward a claim form to you for additional information. This form will need to be filled out entirely and returned to the factory as soon as possible. The warranty claim will be evaluated immediately and may necessitate a review of the product by a factory representative to determine the validity of the claim and the appropriate course of action. In the event of a warranty claim, the sole obligation of Primeway, Inc. to its client in warranting products will be to the extent of repair or replacement at Primeway's option. The warranty applies to those products which prove to be defective during the warranty period, under normal usage and for the purpose intended. Negligence, abuse, alterations, misuse or damage by accident shall void this warranty.

There are no implied warranties of merchantability or fitness of a particular purpose made by Primeway, Inc. in connection with the sale or use of any goods produced by Primeway, Inc. The warranty provisions listed herein are expressly in lieu of any other warranties, expressed or implied by fact or by statute and all other remedies for damages arising from the sale or use of any merchandise.

Charges incurred by the customer for the repair of goods manufactured by Primeway will not be accepted for reimbursement by Primeway. Back charges to the factory will not be accepted without prior written consent from the factory via a Primeway credit memo to the client's account. Primeway reserves the right, at its own discretion, to return the merchandise to the factory for warranty repair to avoid costly field service.

Primeway will only be responsible for the shipping costs incurred on warranty repairs to and from the factory and the original shipping point as noted on the factory shipper or bill of lading. Primeway will attempt to make the warranty repair within seven working days from receipt of goods at the factory and is contingent upon the extensiveness of service required.

ENVIRONMENTALLY RESPONSIBLE:

Primeway is committed to supporting sustainability and the protection of our environment. Our families, employees and customers are very important to us, as well as the general public and future generations. We look to use materials in our products with consideration for their environmental impact and search to discover product innovations that will support cost and performance objectives. These processes will help reduce pollution and waste throughout the life cycle of the product.

Much of our products are produced with recycled post-industrial materials. Primeway is committed to providing products that will improve indoor air quality.

Our products are built to last, creating a long life cycle of use and are produced in a modular fashion where ever possible. This allows disassembly for easier maintenance, repair, and reconfiguration for extended life. This also allows for recovery and reuse of components or materials.

We maintain a program to sort and recycle materials such as paper, plastics, glass, steel and aluminum as well as the use of recycled packaging materials to help in our effort to reduce pollution and waste.

At Primeway we acknowledge the importance of a clean, healthy environment and have a social responsibility to support our community, operate in an ethical manner and continually work towards more sustainable products and workplace solutions.

ACCESSORIES



Model#	Accessory Option	List Price
RWG	Rectangular Grommet	\$25
TFG	Round Grommet	\$25
AWM12	Wire Management Channel 12"	\$42
AWM16	Wire Management Channel 16"	\$48
AWM24	Wire Management Channel 24"	\$66
AWM42	Wire Management Channel 42"	\$89
AWM54	Wire Management Channel 54"	\$118
AWM66	Wire Management Channel 66"	\$144
CGWM	Cable Grip Wire Management	\$18
CMT	Cable Management Tray	\$260
MWM-B	Magnetic Wire Management, Black	\$68
MWM-S	Magnetic Wire Management, Silver	\$68
WMH	Wire Management Holes	\$75
UBH	Undermount Bag/Coat Hook	\$35
CAST-SW	(4) Soft Wheel, 2" Black Casters (for hard floors)	\$125
CAST-HW	(4) Hard Wheel, 2" Black Casters (for carpeted floors)	\$90

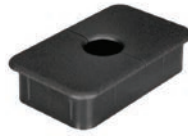

- 3 1/2" L x 2 1/8" W Rectangle, Black Plastic
- 2 Piece Removable Top with Center Hole
- Requires a 3/4" x 1 1/8" hole

- 3" Round, Black Plastic
- 1 Piece with Wire Access
- Requires a 2 3/8" Diameter Hole

Factory cut hole to specified location, can also be field installed by other.

- 1 9/16" W x 1 1/4" D, Black PVC
- 6 Length Options
- Attaches to the Underside of the Top with Double Sided Tape & 2 Screws- *provided*



- 3 1/2" L x 2 1/2" W x 1 1/4" D, Black Plastic
- Cord Snaps in Loops
- Attaches to the Underside of the Top with Screws- *provided*

- 15" L x 8" W x 4" D
- Metal, Black Winkle
- Attaches to the Underside of the Top with Screws- *provided*



- 17 3/4" L x 2" W x 1" D
- Positionable on Leg Surface
- Black or Silver Metal



- 1 1/4" holes: 2 per leg
- Leg Location: Inside Top & Bottom

- 1-Hook, Screws & Pre-Drilled Holes
- Specify Location When Ordering
- Mounted 2" Back From Table Edge (unless specified otherwise)
- Black Metal





Model#	Accessory Option	List Price		
PPD5				
PPD5-B	2 Power, Black Powdercoat	\$329	 <ul style="list-style-type: none"> • Pop Up Lid- Open During Use, UL Listed • Available with <ul style="list-style-type: none"> - 15 Amp Electrical Simplex Outlets - Blank Data Ports - 72" Cord 	
PPD5-S	2 Power, Silver Powdercoat	\$329		
PPD5P-B	1 Power, 1 Blank, Black Powdercoat	\$315		
PPD5P-S	1 Power, 1 Blank, Silver Powdercoat	\$315		
PPD10				
PPD10-A	2 Power, 2 Blank, Silver Aluminum	\$465	 <ul style="list-style-type: none"> • Fluid One Touch Door- Open During Use, UL Listed • Voice/Data Adapter Kit for Customers Coupler & Jacks • Available with <ul style="list-style-type: none"> - 15 Amp Electrical Simplex Outlets - Blank Data Ports - 72" Cord 	
PPD10-B	2 Power, 2 Blank, Black	\$573		
PPD30				
PPD30-A	4 Power, 4 Blank, Silver Aluminum	\$900	 <ul style="list-style-type: none"> • Double Sided, One Touch Doors- Open During Use, UL Listed • Voice/Data Adapter Kit for Customers Coupler & Jacks • Available with <ul style="list-style-type: none"> - 15 Amp Electrical Simplex Outlets - Blank Data Ports - 120" Cord 	
PPD30-B	4 Power, 4 Blank, Black	\$1,134		
PPD50				
PPD50-A	3 Power, 3 Blank, Silver Aluminum	\$601	 <ul style="list-style-type: none"> • Flush with surface • Retractable Door Can Be Closed During Use, UL Listed • Voice/Data Adapter Kit for Customers Coupler & Jacks • Available with <ul style="list-style-type: none"> - 15 Amp Waterproof Electrical Simplex Outlets - Blank Data Ports - 120" Cord 	
PPD50-B	3 Power, 3 Blank, Black	\$742		

See Next Page for Data Options

BRACKETS

FPB	Flat Plate Connecting Brackets	\$16
GANG	Quick Connect Ganging Brackets	\$53

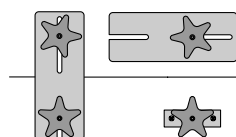
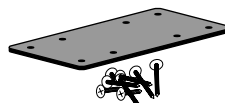



Model#	Accessory Option	List Price
PPD52		
PPD52-B	1 Power, 1 Dual USB A+C, Black Powdercoat	\$442
PPD52-S	1 Power, 1 Dual USB A+C, Silver Powdercoat	\$442
PPD70		
PPD70-B	2 Power, Black Powdercoat	\$246
PPD70-S	2 Power, Silver Powdercoat	\$246
PPD70P-B	1 Power, 1 Blank, Black Powdercoat	\$239
PPD70P-S	1 Power, 1 Blank, Silver Powdercoat	\$239
PPD70U-B	1 Power, 1 Dual USB, Black Powdercoat	\$311
PPD70U-S	1 Power, 1 Dual USB, Silver Powdercoat	\$311
PPD80		
PPD80P-W	2 Power, 2 Blank, White Gloss	\$312
PPD80P-B	2 Power, 2 Blank, Black Gloss	\$389
PPD80U-W	2 Power, 1 Blank, 1 Dual USB, White Gloss	\$403
PPD80U-B	2 Power, 1 Blank, 1 Dual USB, Black Gloss	\$478
PPD90		
PPD90P-W	2 Power, 2 Blank, White Gloss	\$347
PPD90P-B	2 Power, 2 Blank, Black Gloss	\$424
PPD90U-W	2 Power, 1 Blank, 1 Dual USB, White Gloss	\$437
PPD90U-B	2 Power, 1 Blank, 1 Dual USB, Black Gloss	\$513
PPD92		
PPD92-B	1 Power, 1 Dual USB A+C, Black Powdercoat	\$442
PPD92-S	1 Power, 1 Dual USB A+C, Silver Powdercoat with black outlets	\$442



- Pop Up Lid- Open During Use
- UL Listed, Available with:
 - 15 Amp Electrical Simplex Outlet
 - 1 USB A+C
 - 72" Cord



- Sits 1/4" Above Surface
- Available with:
 - 15 Amp Electrical Simplex Outlets
 - Dual USB
 - Blank Data Ports
 - 72" Cord



- Horizontal Mount on Top Edge, No Hole Needed
- Voice/Data Adapter Kit for Customers Coupler & Jacks
- UL listed, Available with:
 - 15 Amp Waterproof Electrical Simplex Outlets
 - Dual USB
 - Blank Data Ports
 - 72" Cord



- Semi-Flush Sits 1/4" Above Surface
- Voice/Data Adapter Kit for Customers Coupler & Jacks
- UL listed, Available with:
 - 15 Amp Waterproof Electrical Simplex Outlets
 - Dual USB
 - Blank Data Ports
 - 72" Cord



- Semi-Flush Sits 1/4" Above Surface
- UL Listed, Available with:
 - 1 Power Outlet
 - 1 USB A+C
 - Spill Proof Outlets
 - 72" Cord

Compatible Data		
Model#	Accessory Options For PPD Units: 5, 10, 30, 50, 52, 70, 80, 90, 92	List Price
VGA	VGA Connector	\$84
HDMI	HDMI Coupler	\$69
USB	USB 3.0	\$44
STR	3.5mm Stereo	\$17
RJC	RJ11 Voice Coupler	\$15
RJVC	RJ11 Voice Cord	\$12
RJ45Cat5E	Cat5E Panduit Jack & Network Cable, M/F 9'cord	\$61
USBAC	USB A+C	\$44



Model#	Accessory Option	List Price
PPD120		
PPD120-B	6 Power, 2 Telecom cutouts, 2-108" Cords, Black	\$2,257
PPD120-S	6 Power, 2 Telecom cutouts, 2-108" Cords, Silver	\$2,257
PPD120H-B	4 Power, 3 Telecom cutouts, 2-108" Cords, Black	\$2,257
PPD120H-S	4 Power, 3 Telecom cutouts, 2-108" Cords, Silver	\$2,257
PPD130		
PPD130P-B	2 Power, 2 Blank, 72" Cord, Black Powdercoat	\$417
PPD130P-S	2 Power, 2 Blank, 72" Cord, Silver Powdercoat	\$417
PPD130U-B	2 Power, Dual USB, 2 Blank, 72" Cord, Black Powdercoat	\$523
PPD130U-S	2 Power, Dual USB, 2 Blank, 72" Cord, Silver Powdercoat	\$523
PPD130P-BD	2 Power, 2 RJ45 Cat 6, 72" Cord, Black Powdercoat	\$532
PPD130P-SD	2 Power, 2 RJ45 Cat 6, 72" Cord, Silver Powdercoat	\$532

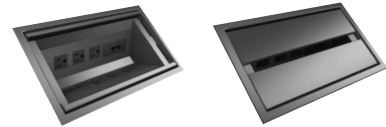

- Retractable Double Doors, Can Be Closed During Use
 - UL Listed, Available with
 - Power Outlets
 - Telecom Plate Cutouts
- (See Telecom Plate Options Below)



- Flip Lid, Flush with Surface, Mounts Under Top
- UL Listed, Available with:
 - Power Outlets
 - Dual USB
 - Blank Data Ports
 - RJ45 Cat 6 Data Ports

Compatible Telecom Plate Options ONLY for Model# PPD120

Code	Description	List Price	Code	Description	List Price
TP-1	1) RJ11 Cat 3 Phone and 1) RJ45 Cat 6 Data	\$91	TP-9	1) Mini-Stereo Inline & 1) 15 Pin HD VGA with Male/Male 72" Patchcord	\$161
TP-2	2) RJ45 Cat 6 Connectors	\$121	TP-10	Cord-minder Plate with 2) 5/8" holes & 1) 7/8" hole	\$36
TP-3	3) RJ45 Cat 6 Connectors	\$174	TP-11	1) HDMI Female/Female with 36" patchcord, 1) Mini-Stereo & 1) 15 Pin HD VGA with Male/Male 72" Patchcord	\$284
TP-4	4) RJ45 Cat 6 Connectors	\$231	TP-12	3) RJ45 Cat 5E Data	\$175
TP-5	1) RJ45 Cat 6 Data, 1) Mini-Stereo, & 1) 15 Pin HD VGA with Male/Male 72" Patchcord	\$207	TP-13	1) RJ45 Cat 6 Inline & 1) RJ11 Cat 3 Phone Inline	\$91
TP-6	2) RJ45 Cat 6 Data, 1) Mini-Stereo & 1) 15 Pin HD VGA with Male/Male 72" Patchcord	\$238	TP-14	1) HDMI Female/Female with 36" Patchcord	\$139
TP-7	1) RJ11 Cat 3 Phone & 1) RJ45 Cat 6 Data & 1) USB Patchcord	\$217	TP-15	1) RJ11 Cat 3 Phone and 2) RJ45 Cat 6 Data	\$151
TP-8	1) RJ45 Cat 6 Data	\$64	TP-BLANK	Blank Telecom Plate	\$7

CONSULT FACTORY FOR OTHER DATA NEEDS



Conference Tables - Standard Power-Data Grommet Locations

Grommets are not typically located over bases
See Power / Data Solutions for a list of grommets available

Grommet Location - 1

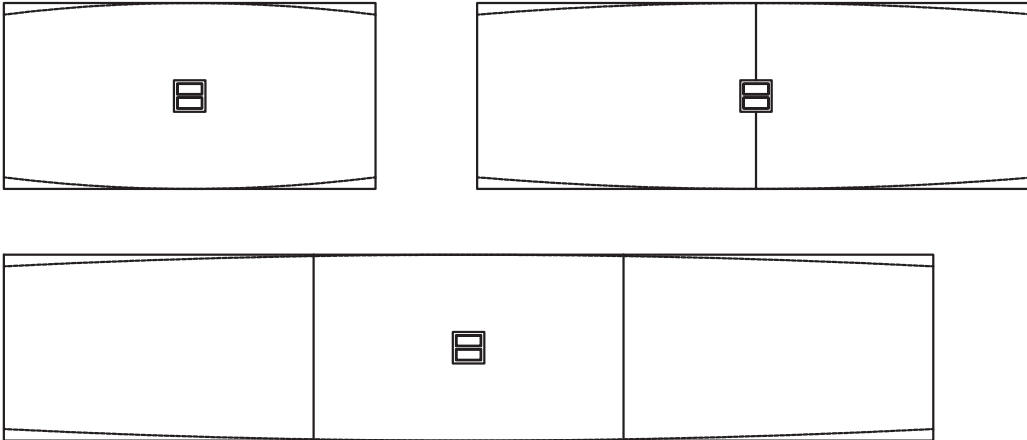

Grommet Location - 2

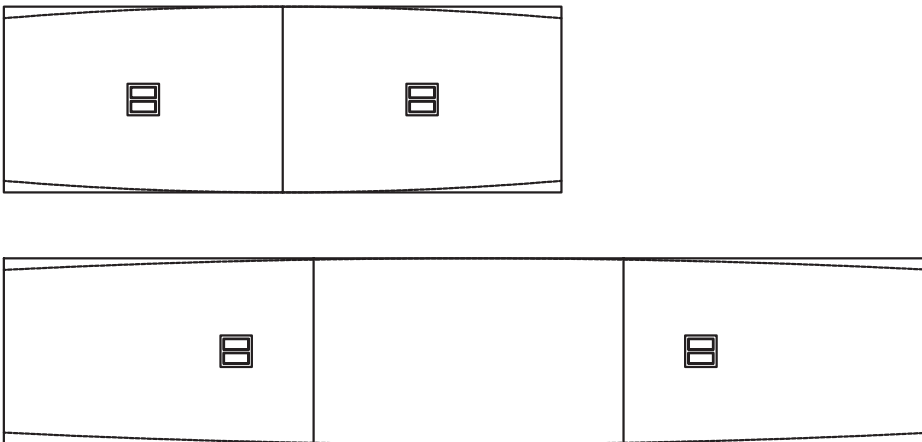

Grommet Location - 3

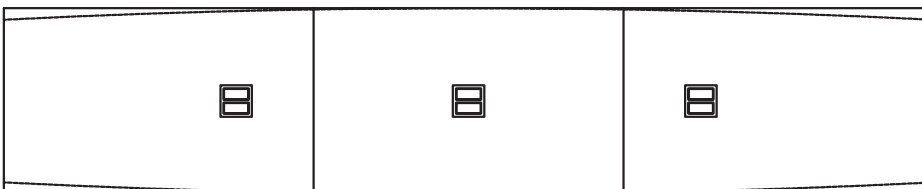



PRIMEWAY STANDARD FINISH OPTIONS | REFERENCE PRIMEWAY'S 2023 STANDARD COLOR CARD FOR SWATCHES (PDF DOWNLOAD AVAILABLE AT PRIMEWAYINC.COM)

SURFACES | 44 Standard HPL Solids, Patterns & Woodgrains (non-standard options below)

EDGES | Matching or Coordinating Finishes | Available in the following edge options:

ABS 1: PVC-free impact resistant flat edge band with each standard HPL.

ABS 2: Multi-Ply "Plywood Look" flat vinyl edge.

ABS 3: Knife profile, 1/2" flat edge with bevel painted in companion color.

METAL BASES | 11 Powdercoat finishes: black, black wrinkle, light gray, medium tone, putty, silver metallic, slate, soft white, (red, green & blue & others available- consult factory for details).

NON-STANDARD FINISH OPTIONS & CHARGES

WILSONART HPLs

5% Upcharge for Matte finish codes: -38, -60

10% Upcharge for Premium finish codes: -07, -18, -22, -78

15% Upcharge for Premium finish codes: -12, -16, -19, -21, -22, -28, -35, -45, -52, -55, -88

For all other Non-Standard Wilsonart finishes, consult factory for pricing.

FORMICA HPLs

10% Upcharge for matte finish code: -58

15% Upcharge for matte finish codes: -42, -43, -SP, -MC, -NT, -WR

For all other Non-Standard Formica finishes, consult factory for pricing.

PIONITE & NEVAMAR HPLs

15% Upcharge for Pionite matte finish codes: Textured, Suede

15% Upcharge for Nevamar matte finish codes: Textured, Suede

For all other Non-Standard Pionite or Nevamar finishes, consult factory for pricing.

SELF EDGE TOPS

Add 20% to the net price for square & rectangular tables.

Add 30% to the net price for all other table shapes.

SPECIAL HPLs & OTHER FINISH TYPES | CONSULT FACTORY FOR SPECIAL PRICING & AVAILABILITY:

Dry Erase/Marker Surfaces

Chemical Resistant

ESD (ElectroStatic Dissipating)

Fingerprint Resistant

High Wear

Special Formats (Imprinted Logos/Designs)

Solid Surfaces

Any HPL brands or finishes not listed above.

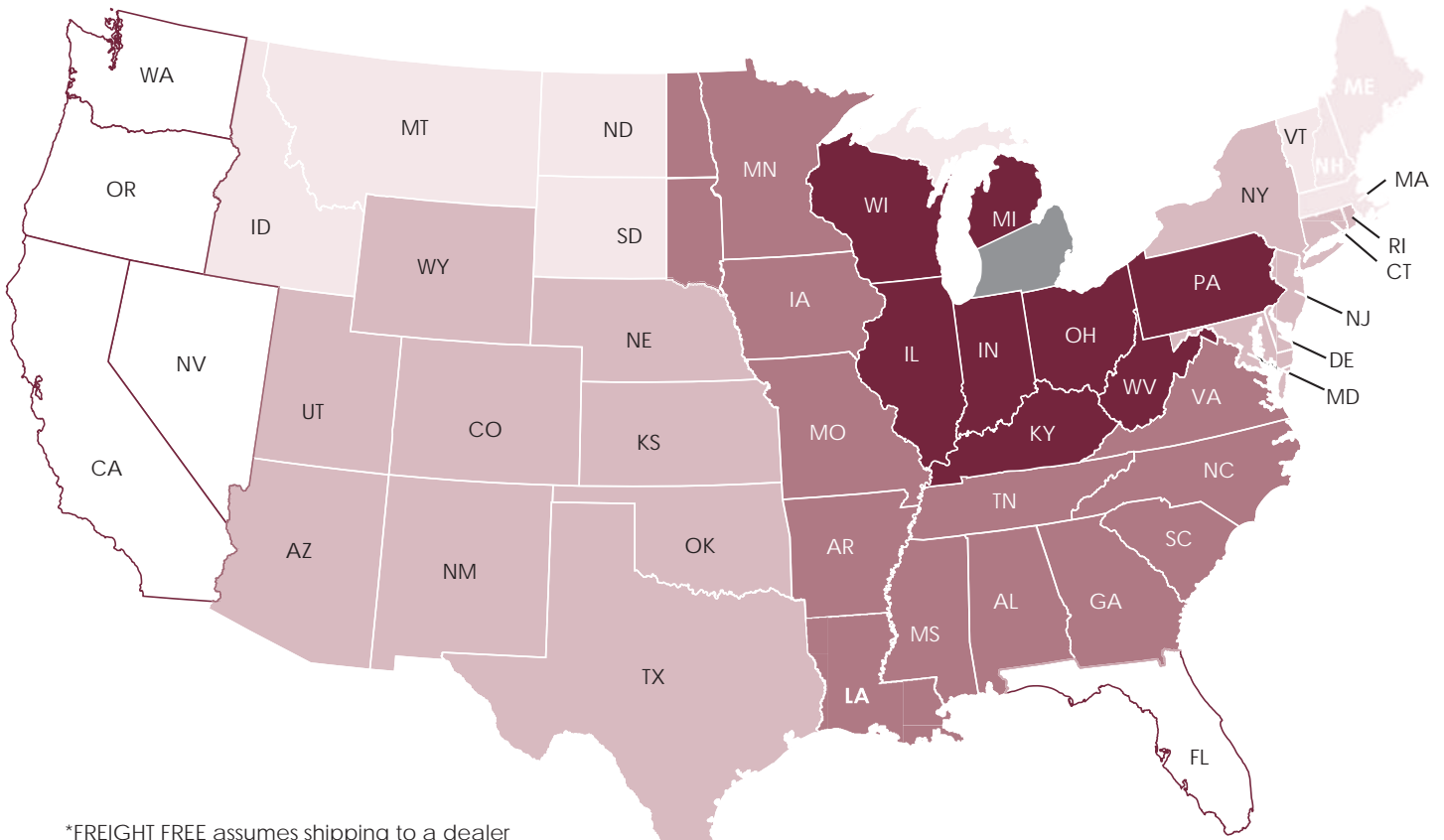

*FREIGHT FREE assumes shipping to a dealer warehouse receiving dock with the proper material handling equipment for dock height unloading during normal business hours.

Under \$1,500 Net	\$1,500-\$3000 Net	\$3,001-\$5,000 Net	\$5,001-\$7,500 Net	Over \$7,500 Net
-------------------	--------------------	---------------------	---------------------	------------------

Zone A: Southeast & Southwest Michigan	\$150	\$125	* FREIGHT FREE		
Zone 1: Indiana, Illinois, Kentucky, Lower Michigan, Ohio, Pennsylvania, West Virginia, Wisconsin	\$175	\$150	\$125	* FREIGHT FREE	
Zone 2: Alabama, Arkansas, Georgia, Iowa, Louisiana, Minnesota, Missouri, Mississippi, North Carolina, Tennessee, South Carolina, Virginia <i>*Eastern Borders of North Dakota, South Dakota</i>	\$250	\$225	\$200	* FREIGHT FREE	
Zone 3: Arizona, Colorado, Connecticut, Delaware, Kansas, Maryland, New Mexico, Nebraska, New Jersey, New York, Oklahoma, Rhode Island, Texas, Utah, Wyoming	\$325	\$275	\$225	* FREIGHT FREE	
Zone 4: Idaho, Montana, Massachusetts, Michigan's Upper Peninsula, Maine, New Hampshire, North Dakota, South Dakota, Vermont	\$300	\$275	\$250	\$225	\$200
Zone 5: California, Nevada, Oregon, Washington, Florida, Alaska, Hawaii	FREIGHT MUST BE QUOTED, CALL FOR RATES: 248-583-6922				

- All freight is normal delivery to a receiving dock only.
- This freight map applies to Primeway's Standard Catalog items only.
- \$200 net surcharge will be applied to all tops 96" long or larger.

- No allowances have been made for deliveries to the end user, residential deliveries, lift gate requirements, after hours deliveries, or any other special applications. Additional expenses as a result of these needs will be the responsibility of the dealer and should be specified prior to order entry to determine applicable charges.

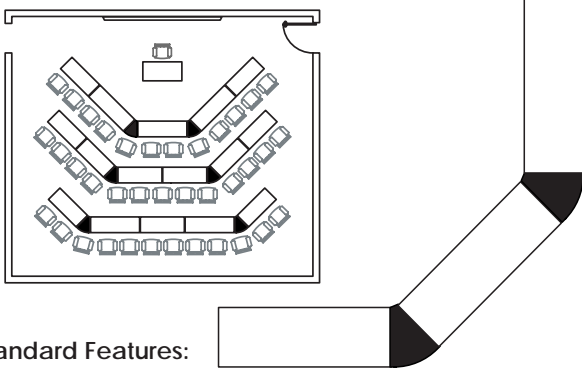

HPL TOPS | 44 standard HPL finishes

METAL BASES | 11 powder coat finishes

EDGES | matching & coordinating finishes in the following options:

ABS 1: PVC-free impact resistant flat edge (S)

ABS 2: Multi-Ply "Plywood Look" flat vinyl edge (M)

ABS 3: Knife (KV), 1/2" Flat edge- bevel painted in a companion color

- Refer to edge code, above in (), when pricing below -

Standard Features:

- Tops Only. No Bases.
- (4) Flat plate connection brackets included with spanner tops.
- Wire Management, Ganging Brackets, etc. available, consult factory.

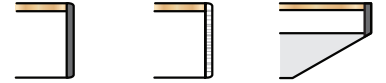

	SIZE AXB	MODEL #	<u>ABS 1</u> S	<u>ABS 2</u> M	<u>ABS 3</u> KV
30 DEGREE WEDGE SHAPE TOP					
	18 x 12	SP3W18	\$301	\$338	\$350
	20 x 13	SP3W20	\$327	\$369	\$381
	24 x 15	SP3W24	\$380	\$429	\$444
	30 x 18	SP3W30	\$443	\$504	\$523
45 DEGREE WEDGE SHAPE TOP					
	18 x 16	SP45W18	\$275	\$315	\$327
	20 x 18	SP45W20	\$301	\$346	\$360
	24 x 21	SP45W24	\$348	\$401	\$418
	30 x 26	SP45W30	\$419	\$486	\$507
60 DEGREE WEDGE SHAPE TOP					
	18 x 21	SP6W18	\$258	\$303	\$316
	20 x 23	SP6W20	\$278	\$327	\$342
	24 x 27	SP6W24	\$317	\$376	\$394
	30 x 30	SP6W30	\$374	\$444	\$466
90 DEGREE QUARTER ROUND TOP					
	18 x 25	SP9QR18	\$321	\$369	\$383
	20 x 28	SP9QR20	\$354	\$407	\$423
	24 x 34	SP9QR24	\$419	\$483	\$503
	30 x 42	SP9QR30	\$516	\$596	\$620
90 DEGREE TRIANGLE TOP					
	18 x 25	SP9W18	\$291	\$338	\$353
	20 x 28	SP9W20	\$360	\$413	\$429
	24 x 34	SP9W24	\$427	\$491	\$510
	30 x 42	SP9W30	\$523	\$602	\$626

NOTE:

* Non-flat edge profiles (KV) are only applied to the exposed edges (SIDE B) of Spanner Tops. SIDE A Edges are either a matching or coordinating vinyl edge.



DC SERIES



OPTIONAL:
Decorative Foot Extension in Black.
Add \$190.00 List.
Consult factory for other colors.

Standard Features:

- Adjustable leveling glides included.
- Power/Data options available, consult factory.
- For additional base options (casters, flip top, etc.), consult factory.

HPL TOPS | 44 standard HPL finishes

METAL BASES | 11 powder coat finishes

EDGES | matching & coordinating finishes in the following options:



ABS 1: PVC-free impact resistant flat edge (S)

ABS 2: Multi-Ply "Plywood Look" flat vinyl edge (M)

ABS 3: Knife (KV), 1/2" Flat edge- bevel painted in a companion color

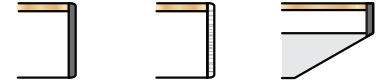
- Refer to edge code, above in (), when pricing below -

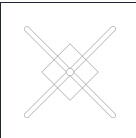

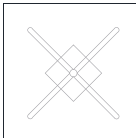
SIZE	BASE INFO #, Style	MODEL #	ABS 1 S	ABS 2 M	ABS 3 KV	
ROUND TOP CAFE HEIGHT 42" H.						
	24" Dia. x 42	(1) X-Base	TDCRX2442	\$691	\$750	\$768
	30" Dia. x 42	(1) X-Base	TDCRX3042	\$762	\$835	\$858
	36" Dia. x 42	(1) X-Base	TDCRX3642	\$869	\$957	\$984
	42" Dia. x 42	(1) X-Base	TDCRX4242	\$1,005	\$1,108	\$1,139
	48" Dia. x 42	(1) X-Base	TDCRX4842	\$1,083	\$1,200	\$1,236
	54" Dia. x 42	(1) X-Base	TDCRX5442	\$1,201	\$1,333	\$1,374
SQUARE TOP CAFE HEIGHT 42" H.						
	18 x 18 x 42	(1) X-Base	TDCSX1842	\$638	\$695	\$712
	24 x 24 x 42	(1) X-Base	TDCSX2442	\$691	\$766	\$789
	30 x 30 x 42	(1) X-Base	TDCSX3042	\$762	\$855	\$884
	36 x 36 x 42	(1) X-Base	TDCSX3642	\$909	\$1,021	\$1,056
	42 x 42 x 42	(1) X-Base	TDCSX4242	\$1,035	\$1,166	\$1,206
ROUND TOP SEATED HEIGHT 29" H.						
	24" Dia. x 29	(1) X-Base	TDCRX2429	\$631	\$689	\$707
	30" Dia. x 29	(1) X-Base	TDCRX3029	\$705	\$779	\$801
	36" Dia. x 29	(1) X-Base	TDCRX3629	\$813	\$901	\$929
	42" Dia. x 29	(1) X-Base	TDCRX4229	\$948	\$1,051	\$1,082
	48" Dia. x 29	(1) X-Base	TDCRX4829	\$1,026	\$1,144	\$1,180
	54" Dia. x 29	(1) X-Base	TDCRX5429	\$1,152	\$1,284	\$1,325
SQUARE TOP SEATED HEIGHT 29" H.						
	18 x 18 x 29	(1) X-Base	TDCSX1829	\$578	\$634	\$651
	24 x 24 x 29	(1) X-Base	TDCSX2429	\$631	\$706	\$729
	30 x 30 x 29	(1) X-Base	TDCSX3029	\$705	\$799	\$827
	36 x 36 x 29	(1) X-Base	TDCSX3629	\$853	\$965	\$999
	42 x 42 x 29	(1) X-Base	TDCSX4229	\$982	\$1,113	\$1,153



OPTIONAL:
Decorative Foot Extension in Black.
Add \$95.00 List- Per Double Leg.
Consult factory for other colors.

Standard Features:

- Adjustable leveling glides included.
- Power/Data options available, see Power/Data Solutions page.
- For additional base options (casters, flip top, folding, etc.), consult factory.

NOTE: See next page for "Mobile Flip Top" Tables.

- Modesty panel, wire management, grommets, etc. available, consult factory.

HPL TOPS | 44 standard HPL finishes

METAL BASES | 11 powder coat finishes

EDGES | matching & coordinating finishes in the following options:

ABS 1: PVC-free impact resistant flat edge (S)

ABS 2: Multi-Ply "Plywood Look" flat vinyl edge (M)

ABS 3: Knife (KV), 1/2" Flat edge- bevel painted in a companion color

- Refer to edge code, above in (), when pricing below -

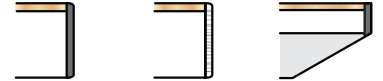

SIZE	BASE INFO #, Style	MODEL #	ABS 1 S	ABS 2 M	ABS 3 KV	
RECTANGULAR TABLES						
	18 x 42 x 29	(2) T-Base	TDC1842	\$691	\$785	\$814
	18 x 48 x 29	(2) T-Base	TDC1848	\$723	\$826	\$857
	18 x 60 x 29	(2) T-Base	TDC1860	\$842	\$964	\$1,001
	18 x 72 x 29	(2) T-Base	TDC1872	\$888	\$1,028	\$1,071
	18 x 84 x 29	(2) T-Base	TDC1884	\$952	\$1,111	\$1,160
	18 x 96 x 29	(2) T-Base	TDC1896	\$995	\$1,172	\$1,227
	20 x 42 x 29	(2) T-Base	TDC2042	\$729	\$826	\$855
	20 x 48 x 29	(2) T-Base	TDC2048	\$749	\$855	\$888
	20 x 60 x 29	(2) T-Base	TDC2060	\$866	\$991	\$1,029
	20 x 72 x 29	(2) T-Base	TDC2072	\$913	\$1,056	\$1,100
20 x 84 x 29	(2) T-Base	TDC2084	\$983	\$1,145	\$1,195	
20 x 96 x 29	(2) T-Base	TDC2096	\$1,028	\$1,208	\$1,264	
24 x 42 x 29	(2) T-Base	TDC2442	\$768	\$871	\$903	
24 x 48 x 29	(2) T-Base	TDC2448	\$788	\$900	\$935	
24 x 60 x 29	(2) T-Base	TDC2460	\$908	\$1,039	\$1,079	
24 x 72 x 29	(2) T-Base	TDC2472	\$957	\$1,107	\$1,153	
24 x 84 x 29	(2) T-Base	TDC2484	\$1,045	\$1,213	\$1,265	
24 x 96 x 29	(2) T-Base	TDC2496	\$1,093	\$1,280	\$1,337	
30 x 42 x 29	(2) T-Base	TDC3042	\$879	\$991	\$1,026	
30 x 48 x 29	(2) T-Base	TDC3048	\$900	\$1,022	\$1,059	
30 x 60 x 29	(2) T-Base	TDC3060	\$1,023	\$1,163	\$1,206	
30 x 72 x 29	(2) T-Base	TDC3072	\$1,084	\$1,243	\$1,292	
30 x 84 x 29	(2) T-Base	TDC3084	\$1,179	\$1,356	\$1,411	
30 x 96 x 29	(2) T-Base	TDC3096	\$1,213	\$1,409	\$1,469	
36 x 42 x 29	(2) T-Base	TDC3642	\$943	\$1,065	\$1,102	
36 x 48 x 29	(2) T-Base	TDC3648	\$972	\$1,103	\$1,143	
36 x 60 x 29	(2) T-Base	TDC3660	\$1,109	\$1,259	\$1,305	
36 x 72 x 29	(2) T-Base	TDC3672	\$1,186	\$1,354	\$1,406	
36 x 84 x 29	(2) T-Base	TDC3684	\$1,264	\$1,451	\$1,509	
36 x 96 x 29	(2) T-Base	TDC3696	\$1,317	\$1,523	\$1,586	

VIDEO CONFERENCE SHAPE TABLES

THE VIDEO CONFERRING SHAPE (-VC) CAN BE USED TO CREATE MANY CONFIGURATIONS, (BELOW LEFT)
OVERALL SIZE OF TABLE (D x W) LISTED IS NOMINAL AND MAY VARY +/- 1/2"

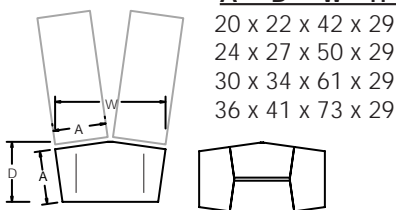

20 x 22 x 42 x 29	(2) T-Base	TDC2242-VC	\$922	\$1,017	\$1,046
24 x 27 x 50 x 29	(2) T-Base	TDC2750-VC	\$1,035	\$1,149	\$1,184
30 x 34 x 61 x 29	(2) T-Base	TDC3461-VC	\$1,259	\$1,400	\$1,444
36 x 41 x 73 x 29	(2) T-Base	TDC4173-VC	\$1,442	\$1,611	\$1,663

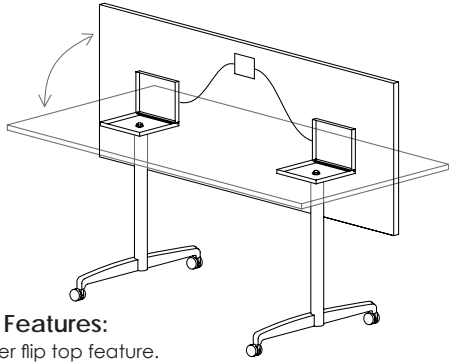

Standard Features:

- Single lever flip top feature.
- 2" Locking casters included. (Specify for hard floor or carpeted areas)
- Power/Data options available, see Power/Data Solutions page.
- Modesty panel, wire management, grommets, etc. available, consult factory.

HPL TOPS | 44 standard HPL finishes

METAL BASES | 11 powder coat finishes

EDGES | matching & coordinating finishes in the following options:

ABS 1: PVC-free impact resistant flat edge (S)

ABS 2: Multi-Ply "Plywood Look" flat vinyl edge (M)

ABS 3: Knife (KV), 1/2" Flat edge- bevel painted in a companion color

- Refer to edge code, above in (), when pricing below -

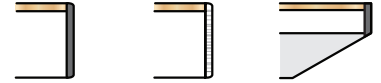

SIZE	BASE INFO #, Style	MODEL #	ABS 1 S	ABS 2 M	ABS 3 KV	
RECTANGULAR TABLES WITH FLIP TOP MECHANISM						
	18 x 42 x 29	(2) T-Base	TDC1842-FL	\$1,117	\$1,210	\$1,239
	18 x 48 x 29	(2) T-Base	TDC1848-FL	\$1,148	\$1,251	\$1,283
	18 x 60 x 29	(2) T-Base	TDC1860-FL	\$1,268	\$1,389	\$1,427
	18 x 72 x 29	(2) T-Base	TDC1872-FL	\$1,313	\$1,453	\$1,497
	18 x 84 x 29	(2) T-Base	TDC1884-FL	\$1,377	\$1,536	\$1,585
	18 x 96 x 29	(2) T-Base	TDC1896-FL	\$1,420	\$1,598	\$1,652
	20 x 42 x 29	(2) T-Base	TDC2042-FL	\$1,155	\$1,251	\$1,281
	20 x 48 x 29	(2) T-Base	TDC2048-FL	\$1,175	\$1,281	\$1,313
	20 x 60 x 29	(2) T-Base	TDC2060-FL	\$1,292	\$1,416	\$1,455
	20 x 72 x 29	(2) T-Base	TDC2072-FL	\$1,338	\$1,482	\$1,526
	20 x 84 x 29	(2) T-Base	TDC2084-FL	\$1,409	\$1,571	\$1,621
	20 x 96 x 29	(2) T-Base	TDC2096-FL	\$1,453	\$1,634	\$1,689
	24 x 42 x 29	(2) T-Base	TDC2442-FL	\$1,194	\$1,296	\$1,328
	24 x 48 x 29	(2) T-Base	TDC2448-FL	\$1,214	\$1,326	\$1,360
	24 x 60 x 29	(2) T-Base	TDC2460-FL	\$1,333	\$1,464	\$1,504
	24 x 72 x 29	(2) T-Base	TDC2472-FL	\$1,383	\$1,532	\$1,578
	24 x 84 x 29	(2) T-Base	TDC2484-FL	\$1,471	\$1,639	\$1,691
	24 x 96 x 29	(2) T-Base	TDC2496-FL	\$1,519	\$1,705	\$1,763
	30 x 42 x 29	(2) T-Base	TDC3042-FL	\$1,304	\$1,417	\$1,451
	30 x 48 x 29	(2) T-Base	TDC3048-FL	\$1,326	\$1,447	\$1,485
	30 x 60 x 29	(2) T-Base	TDC3060-FL	\$1,448	\$1,588	\$1,631
	30 x 72 x 29	(2) T-Base	TDC3072-FL	\$1,510	\$1,669	\$1,717
	30 x 84 x 29	(2) T-Base	TDC3084-FL	\$1,604	\$1,782	\$1,836
	30 x 96 x 29	(2) T-Base	TDC3096-FL	\$1,638	\$1,834	\$1,895
36 x 42 x 29	(2) T-Base	TDC3642-FL	\$1,369	\$1,490	\$1,528	
36 x 48 x 29	(2) T-Base	TDC3648-FL	\$1,398	\$1,528	\$1,569	
36 x 60 x 29	(2) T-Base	TDC3660-FL	\$1,535	\$1,684	\$1,730	
36 x 72 x 29	(2) T-Base	TDC3672-FL	\$1,612	\$1,780	\$1,832	
36 x 84 x 29	(2) T-Base	TDC3684-FL	\$1,690	\$1,877	\$1,934	
36 x 96 x 29	(2) T-Base	TDC3696-FL	\$1,743	\$1,948	\$2,011	

VIDEO CONFERENCE SHAPE TABLES WITH FLIP TOP MECHANISM THE VIDEO CONFERENCING SHAPE (-VC) CAN BE USED TO CREATE MANY CONFIGURATIONS (BELOW LEFT) OVERALL SIZE OF TABLE (D X W) LISTED IS NOMINAL AND MAY VARY +/- 1/2"

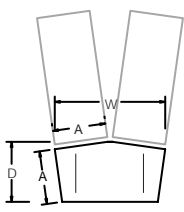

A	D	W	H					
20	22	42	29	(2) T-Base	TDC2242-VC-FL	\$1,347	\$1,442	\$1,471
24	27	50	29	(2) T-Base	TDC2750-VC-FL	\$1,461	\$1,574	\$1,609
30	34	61	29	(2) T-Base	TDC3461-VC-FL	\$1,685	\$1,826	\$1,869
36	41	73	29	(2) T-Base	TDC4173-VC-FL	\$1,867	\$2,036	\$2,088



OPTIONAL:
Decorative Foot Extension in Black.
Add \$95.00 List- Per Double Leg.
Consult factory for other colors.

Standard Features:

- Adjustable leveling glides included.
- Power/Data options available, see Power/Data Solutions page.
- Wire management, grommets, etc. available, consult factory.

(*) Refers to a 2-Piece Top. Spline and Joint Fasteners included with table.
NOTE: Woodgrain pattern alignment between two tops not guaranteed.

HPL TOPS | 44 standard HPL finishes

METAL BASES | 11 powder coat finishes

EDGES | matching & coordinating finishes in the following options:

ABS 1: PVC-free impact resistant flat edge (S)

ABS 2: Multi-Ply "Plywood Look" flat vinyl edge (M)

ABS 3: Knife (KV), 1/2" Flat edge- bevel painted in a companion color

- Refer to edge code, above in (), when pricing below -

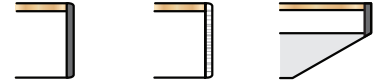

SIZE	BASE INFO #, Style	MODEL #	ABS 1 S	ABS 2 M	ABS 3 KV	
RECTANGLE SHAPE TOP (SQ)						
	42 x 84 x 29	(2) Dbl. T-Base	CDC4284SQ	\$1,782	\$1,991	\$2,055
	42 x 96 x 29	(2) Dbl. T-Base	CDC4296SQ	\$1,914	\$2,129	\$2,195
	48 x 96 x 29	(2) Dbl. T-Base	CDC4896SQ	\$1,951	\$2,175	\$2,244
	* 48 x 120 x 29	(3) Dbl. T-Base	CDC48120SQ	\$2,770	\$3,032	\$3,253
	* 60 x 120 x 29	(3) Dbl. T-Base	CDC60120SQ	\$3,295	\$3,576	\$3,813
	* 48 x 144 x 29	(3) Dbl. T-Base	CDC48144SQ	\$2,972	\$3,271	\$3,524
	* 60 x 144 x 29	(3) Dbl. T-Base	CDC60144SQ	\$3,570	\$3,888	\$4,156
	* 48 x 168 x 29	(4) Dbl. T-Base	CDC48168SQ	\$3,722	\$4,056	\$4,339
* 60 x 168 x 29	(4) Dbl. T-Base	CDC60168SQ	\$4,357	\$4,712	\$5,013	
WEDGE SHAPE TOP (WD)						
	42 x 84 x 29	(2) Dbl. T-Base	CDC4284WD	\$1,910	\$2,119	\$2,183
	42 x 96 x 29	(2) Dbl. T-Base	CDC4296WD	\$2,063	\$2,287	\$2,356
	48 x 96 x 29	(2) Dbl. T-Base	CDC4896WD	\$2,119	\$2,344	\$2,413
	* 48 x 120 x 29	(3) Dbl. T-Base	CDC48120WD	\$2,982	\$3,244	\$3,465
	* 60 x 120 x 29	(3) Dbl. T-Base	CDC60120WD	\$3,560	\$3,840	\$4,077
	* 48 x 144 x 29	(3) Dbl. T-Base	CDC48144WD	\$3,226	\$3,525	\$3,778
	* 60 x 144 x 29	(3) Dbl. T-Base	CDC60144WD	\$3,887	\$4,205	\$4,474
	* 48 x 168 x 29	(4) Dbl. T-Base	CDC48168WD	\$4,020	\$4,354	\$4,636
* 60 x 168 x 29	(4) Dbl. T-Base	CDC60168WD	\$4,727	\$5,082	\$5,383	
BOAT SHAPE TOP (BT)						
	42 x 84 x 29	(2) Dbl. T-Base	CDC4284BT	\$1,944	\$2,153	\$2,217
	42 x 96 x 29	(2) Dbl. T-Base	CDC4296BT	\$2,099	\$2,323	\$2,392
	48 x 96 x 29	(2) Dbl. T-Base	CDC4896BT	\$2,162	\$2,386	\$2,455
	* 48 x 120 x 29	(3) Dbl. T-Base	CDC48120BT	\$3,035	\$3,296	\$3,518
	* 60 x 120 x 29	(3) Dbl. T-Base	CDC60120BT	\$3,627	\$3,907	\$4,144
	* 48 x 144 x 29	(3) Dbl. T-Base	CDC48144BT	\$3,289	\$3,588	\$3,841
	* 60 x 144 x 29	(3) Dbl. T-Base	CDC60144BT	\$3,967	\$4,284	\$4,553
	* 48 x 168 x 29	(4) Dbl. T-Base	CDC48168BT	\$4,093	\$4,427	\$4,709
* 60 x 168 x 29	(4) Dbl. T-Base	CDC60168BT	\$4,819	\$5,174	\$5,475	



OPTIONAL:
Decorative Foot Extension in Black.
Add \$95.00 List- Per Double Leg.
Consult factory for other colors.

Standard Features:

- Adjustable leveling glides included.
- Power/Data options available, see Power/Data Solutions page.
- Wire management, grommets, etc. available, consult factory.

(*) Refers to a 2-Piece Top. Spline and Joint Fasteners included with table.

NOTE: Woodgrain pattern alignment between two tops not guaranteed.

HPL TOPS | 44 standard HPL finishes

METAL BASES | 11 powder coat finishes

EDGES | matching & coordinating finishes in the following options:

ABS 1: PVC-free impact resistant flat edge (S)

ABS 2: Multi-Ply "Plywood Look" flat vinyl edge (M)

ABS 3: Knife (KV), 1/2" Flat edge- bevel painted in a companion color

- Refer to edge code, above in (), when pricing below -

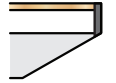

SIZE	BASE INFO #, Style	MODEL #	ABS 1 S	ABS 2 M	ABS 3 KV	
DIAMOND SHAPE TOP (DM)						
	42 x 84 x 29	(2) Dbl. T-Base	CDC4284DM	\$1,944	\$2,153	\$2,217
	42 x 96 x 29	(2) Dbl. T-Base	CDC4296DM	\$2,099	\$2,323	\$2,392
	48 x 96 x 29	(2) Dbl. T-Base	CDC4896DM	\$2,162	\$2,386	\$2,455
	* 48 x 120 x 29	(3) Dbl. T-Base	CDC48120DM	\$3,035	\$3,296	\$3,518
	* 60 x 120 x 29	(3) Dbl. T-Base	CDC60120DM	\$3,627	\$3,907	\$4,144
	* 48 x 144 x 29	(3) Dbl. T-Base	CDC48144DM	\$3,289	\$3,588	\$3,841
	* 60 x 144 x 29	(3) Dbl. T-Base	CDC60144DM	\$3,967	\$4,284	\$4,553
	* 48 x 168 x 29	(4) Dbl. T-Base	CDC48168DM	\$4,093	\$4,427	\$4,709
* 60 x 168 x 29	(4) Dbl. T-Base	CDC60168DM	\$4,819	\$5,174	\$5,475	
BULLET SHAPE TOP (BU)						
	42 x 84 x 29	(2) Dbl. T-Base	CDC4284BU	\$1,944	\$2,126	\$2,183
	42 x 96 x 29	(2) Dbl. T-Base	CDC4296BU	\$2,099	\$2,300	\$2,362
	48 x 96 x 29	(2) Dbl. T-Base	CDC4896BU	\$2,162	\$2,371	\$2,435
	* 48 x 120 x 29	(3) Dbl. T-Base	CDC48120BU	\$3,035	\$3,281	\$3,489
	* 60 x 120 x 29	(3) Dbl. T-Base	CDC60120BU	\$3,627	\$3,891	\$4,115
	* 48 x 144 x 29	(3) Dbl. T-Base	CDC48144BU	\$3,289	\$3,573	\$3,812
	* 60 x 144 x 29	(3) Dbl. T-Base	CDC60144BU	\$3,967	\$4,269	\$4,524
	* 48 x 168 x 29	(4) Dbl. T-Base	CDC48168BU	\$4,093	\$4,413	\$4,685
* 60 x 168 x 29	(4) Dbl. T-Base	CDC60168BU	\$4,819	\$5,159	\$5,446	
BOW END SHAPE TOP (BE)						
	42 x 84 x 29	(2) Dbl. T-Base	CDC4284BE	\$1,944	\$2,153	\$2,217
	42 x 96 x 29	(2) Dbl. T-Base	CDC4296BE	\$2,099	\$2,323	\$2,392
	48 x 96 x 29	(2) Dbl. T-Base	CDC4896BE	\$2,162	\$2,386	\$2,455
	* 48 x 120 x 29	(3) Dbl. T-Base	CDC48120BE	\$3,035	\$3,296	\$3,518
	* 60 x 120 x 29	(3) Dbl. T-Base	CDC60120BE	\$3,627	\$3,907	\$4,144
	* 48 x 144 x 29	(3) Dbl. T-Base	CDC48144BE	\$3,289	\$3,588	\$3,841
	* 60 x 144 x 29	(3) Dbl. T-Base	CDC60144BE	\$3,967	\$4,284	\$4,553
	* 48 x 168 x 29	(4) Dbl. T-Base	CDC48168BE	\$4,093	\$4,427	\$4,709
* 60 x 168 x 29	(4) Dbl. T-Base	CDC60168BE	\$4,819	\$5,174	\$5,475	



OPTIONAL:
Decorative Foot Extension in Black.
Add \$95.00 List- Per Double Leg.
Consult factory for other colors.

Standard Features:

- Adjustable leveling glides included.
- Power/Data options available, see Power/Data Solutions page.
- Wire management, grommets, etc. available, consult factory.

(*) Refers to a 2-Piece Top. Spline and Joint Fasteners included with table.

NOTE: Woodgrain pattern alignment between two tops not guaranteed.

HPL TOPS | 44 standard HPL finishes

METAL BASES | 11 powder coat finishes

EDGES | matching & coordinating finishes in the following options:

ABS 1: PVC-free impact resistant flat edge (S)

ABS 2: Multi-Ply "Plywood Look" flat vinyl edge (M)

ABS 3: Knife (KV), 1/2" Flat edge- bevel painted in a companion color

- Refer to edge code, above in (), when pricing below -

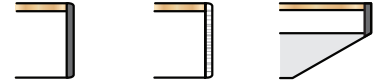

SIZE	BASE INFO #, Style	MODEL #	ABS 1 S	ABS 2 M	ABS 3 KV	
RACETRACK SHAPE TOP (RT)						
	42 x 84 x 29	(2) Dbl. T-Base	CDC4284RT	\$1,961	\$2,129	\$2,181
	42 x 96 x 29	(2) Dbl. T-Base	CDC4296RT	\$2,116	\$2,302	\$2,360
	48 x 96 x 29	(2) Dbl. T-Base	CDC4896RT	\$2,185	\$2,378	\$2,437
	* 48 x 120 x 29	(3) Dbl. T-Base	CDC48120RT	\$3,061	\$3,292	\$3,487
	* 60 x 120 x 29	(3) Dbl. T-Base	CDC60120RT	\$3,659	\$3,909	\$4,119
	* 48 x 144 x 29	(3) Dbl. T-Base	CDC48144RT	\$3,322	\$3,590	\$3,816
	* 60 x 144 x 29	(3) Dbl. T-Base	CDC60144RT	\$4,007	\$4,293	\$4,536
	* 48 x 168 x 29	(4) Dbl. T-Base	CDC48168RT	\$4,129	\$4,434	\$4,691
* 60 x 168 x 29	(4) Dbl. T-Base	CDC60168RT	\$4,866	\$5,189	\$5,462	
BOAT ROUNDED SHAPE TOP (BR)						
	42 x 84 x 29	(2) Dbl. T-Base	CDC4284BR	\$1,961	\$2,169	\$2,234
	42 x 96 x 29	(2) Dbl. T-Base	CDC4296BR	\$2,116	\$2,340	\$2,409
	48 x 96 x 29	(2) Dbl. T-Base	CDC4896BR	\$2,185	\$2,409	\$2,478
	* 48 x 120 x 29	(3) Dbl. T-Base	CDC48120BR	\$3,061	\$3,323	\$3,544
	* 60 x 120 x 29	(3) Dbl. T-Base	CDC60120BR	\$3,659	\$3,940	\$4,177
	* 48 x 144 x 29	(3) Dbl. T-Base	CDC48144BR	\$3,322	\$3,621	\$3,874
	* 60 x 144 x 29	(3) Dbl. T-Base	CDC60144BR	\$4,007	\$4,325	\$4,593
	* 48 x 168 x 29	(4) Dbl. T-Base	CDC48168BR	\$4,129	\$4,463	\$4,746
* 60 x 168 x 29	(4) Dbl. T-Base	CDC60168BR	\$4,866	\$5,221	\$5,521	
OVAL SHAPE TOP (OV)						
	42 x 84 x 29	(2) Dbl. T-Base	CDC4284OV	\$1,961	\$2,118	\$2,166
	42 x 96 x 29	(2) Dbl. T-Base	CDC4296OV	\$2,116	\$2,292	\$2,346
	48 x 96 x 29	(2) Dbl. T-Base	CDC4896OV	\$2,185	\$2,366	\$2,422
	* 48 x 120 x 29	(3) Dbl. T-Base	CDC48120OV	\$3,061	\$3,277	\$3,459
	* 60 x 120 x 29	(3) Dbl. T-Base	CDC60120OV	\$3,659	\$3,884	\$4,075
	* 48 x 144 x 29	(3) Dbl. T-Base	CDC48144OV	\$3,322	\$3,572	\$3,783
	* 60 x 144 x 29	(3) Dbl. T-Base	CDC60144OV	\$4,007	\$4,276	\$4,503
	* 48 x 168 x 29	(4) Dbl. T-Base	CDC48168OV	\$4,129	\$4,454	\$4,729
* 60 x 168 x 29	(4) Dbl. T-Base	CDC60168OV	\$4,866	\$5,209	\$5,500	



OPTIONAL:
Decorative Foot Extension in Black.
Add \$190.00 List.
Consult factory for other colors.

Standard Features:

- Adjustable leveling glides included.
- Power/Data options available, see Power/Data Solutions page.
- Wire management, grommets, etc. available, consult factory.

(*) Refers to a 2-Piece Top. Spline and Joint Fasteners included with table.

NOTE: Woodgrain pattern alignment between two tops not guaranteed.

HPL TOPS | 44 standard HPL finishes

METAL BASES | 11 powder coat finishes

EDGES | matching & coordinating finishes in the following options:

ABS 1: PVC-free impact resistant flat edge (S)

ABS 2: Multi-Ply "Plywood Look" flat vinyl edge (M)

ABS 3: Knife (KV), 1/2" Flat edge- bevel painted in a companion color

- Refer to edge code, above in (), when pricing below -

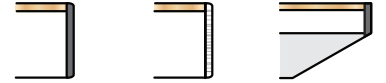

SIZE	BASE INFO #, Style	MODEL #	ABS 1 S	ABS 2 M	ABS 3 KV	
ROUND TOP CAFE HEIGHT 42" H.						
	48" Dia. x 42	(1) 4-Post X-Base	CDC4842RX	\$1,662	\$1,780	\$1,816
	54" Dia. x 42	(1) 4-Post X-Base	CDC5442RX	\$1,812	\$1,944	\$1,985
	60" Dia. x 42	(1) 4-Post X-Base	CDC6042RX	\$2,099	\$2,246	\$2,291
SQUARE TOP CAFE HEIGHT 42" H.						
	48 x 48 x 42	(1) 4-Post X-Base	CDC4842SX	\$1,662	\$1,812	\$1,858
	54 x 54 x 42	(1) 4-Post X-Base	CDC5442SX	\$1,812	\$1,980	\$2,123
	60 x 60 x 42	(1) 4-Post X-Base	CDC6042SX	\$2,099	\$2,286	\$2,444
ROUND TOP SEATED HEIGHT 29"H.						
	48" Dia. x 29	(1) 4-Post X-Base	CDC4829RX	\$1,451	\$1,568	\$1,604
	54" Dia. x 29	(1) 4-Post X-Base	CDC5429RX	\$1,567	\$1,699	\$1,739
	60" Dia. x 29	(1) 4-Post X-Base	CDC6029RX	\$1,888	\$2,034	\$2,079
	* 72" Dia. x 29	(1) 4-Post X-Base	CDC7229RX	\$2,598	\$2,774	\$2,828
	* 84" Dia. x 29	(1) 4-Post X-Base	CDC8429RX	\$3,464	\$3,670	\$3,733
	* 96" Dia. x 29	(1) 4-Post X-Base	CDC9629RX	\$3,564	\$3,798	\$3,871
SQUARE TOP SEATED HEIGHT 29" H.						
	48 x 48 x 29	(1) 4-Post X-Base	CDC4829SX	\$1,451	\$1,600	\$1,646
	54 x 54 x 29	(1) 4-Post X-Base	CDC5429SX	\$1,567	\$1,735	\$1,877
	60 x 60 x 29	(1) 4-Post X-Base	CDC6029SX	\$1,888	\$2,074	\$2,233
	* 72 x 72 x 29	(1) 4-Post X-Base	CDC7229SX	\$2,598	\$2,822	\$3,012
	* 84 x 84 x 29	(1) 4-Post X-Base	CDC8429SX	\$3,464	\$3,726	\$3,947
	* 96 x 96 x 29	(1) 4-Post X-Base	CDC9629SX	\$3,564	\$3,863	\$4,116



OPTIONAL:
Decorative Foot Extension in Black.
Add \$190.00 List.
Consult factory for other colors.

Standard Features:

- Adjustable leveling glides included.
- Power/Data options available, consult factory
- Wire management, grommets, etc. available, consult factory.

HPL TOPS | 44 standard HPL finishes

METAL BASES | 11 powder coat finishes

EDGES | matching & coordinating finishes in the following options:

ABS 1: PVC-free impact resistant flat edge (S)

ABS 2: Multi-Ply "Plywood Look" flat vinyl edge (M)

ABS 3: Knife (KV), 1/2" Flat edge- bevel painted in a companion color

- Refer to edge code, above in (), when pricing below -

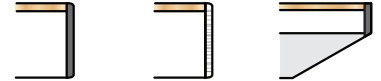

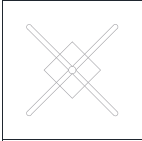
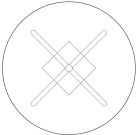
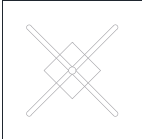
SIZE	BASE INFO #, Style	MODEL #	ABS 1 S	ABS 2 M	ABS 3 KV	
ROUND TOP SIDE TABLE 22" H.						
	24" Dia. x 22	(1) X-Base	ODCR2422	\$810	\$868	\$886
	30" Dia. x 22	(1) X-Base	ODCR3022	\$888	\$961	\$984
	36" Dia. x 22	(1) X-Base	ODCR3622	\$992	\$1,080	\$1,107
	42" Dia. x 22	(1) X-Base	ODCR4222	\$1,234	\$1,337	\$1,368
	48" Dia. x 22	(1) X-Base	ODCR4822	\$1,291	\$1,408	\$1,444
SQUARE TOP SIDE TABLE 22" H.						
	24 x 24 x 22	(1) X-Base	ODCS2422	\$810	\$884	\$907
	30 x 30 x 22	(1) X-Base	ODCS3022	\$888	\$981	\$1,010
	36 x 36 x 22	(1) X-Base	ODCS3622	\$992	\$1,104	\$1,139
	42 x 42 x 22	(1) X-Base	ODCS4222	\$1,234	\$1,365	\$1,405
	48 x 48 x 22	(1) X-Base	ODCS4822	\$1,291	\$1,440	\$1,486
ROUND TOP COFFEE TABLE 17" H.						
	24" Dia. x 17	(1) X-Base	ODCR2417	\$797	\$856	\$873
	30" Dia. x 17	(1) X-Base	ODCR3017	\$875	\$949	\$971
	36" Dia. x 17	(1) X-Base	ODCR3617	\$980	\$1,068	\$1,095
	42" Dia. x 17	(1) X-Base	ODCR4217	\$1,221	\$1,324	\$1,356
	48" Dia. x 17	(1) X-Base	ODCR4817	\$1,278	\$1,395	\$1,432
SQUARE TOP COFFEE TABLE 17" H.						
	24 x 24 x 17	(1) X-Base	ODCS2417	\$797	\$872	\$895
	30 x 30 x 17	(1) X-Base	ODCS3017	\$875	\$969	\$997
	36 x 36 x 17	(1) X-Base	ODCS3617	\$980	\$1,092	\$1,126
	42 x 42 x 17	(1) X-Base	ODCS4217	\$1,221	\$1,352	\$1,393
	48 x 48 x 17	(1) X-Base	ODCS4817	\$1,278	\$1,428	\$1,474



DC XL SERIES



CONTENTS

Overview 23

TABLE PRICING

Rectangle 24

Wedge 26

Boat 28

Diamond 30

Bow End 32

Oval 34

Racetrack 35

Boat-R..... 37

Soft Wedge 39

Bullet 41

Soft Pentagon..... 42

Media Share 42

Media Pear 43

Media Wedge 44



DC-XL collection by Primeway was tailored to suit a breadth of table shapes & sizes. The metal framework assembly features slender double column Y bases with low-profile feet. Table lengths 120" & up include matching T bases. All columns are linked by stretcher bars, forming a sleek & unified structure for ultimate stability.

BASE STYLE | DOUBLE COLUMN LOW PROFILE Y-BASES, LINKED BY STRETCHER BARS, ELONGATED TABLES INCLUDE MATCHING T-BASES



- Low profile feet
- 3 Heights: 29", 36", 42"
- 11 powder coat finishes
- Leveling glides included

Configurations:

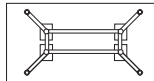

(2) Y | Lengths up to 108"

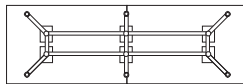

(2) Y, (1) T | 120" & 144" Lengths (2 piece tops)

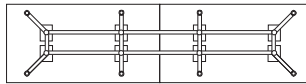

(2) Y, (2) T | 156", 168" & 180" Lengths (2 piece tops)

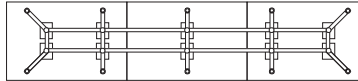

(2) Y, (3) T | 192" - 240" Lengths (3 piece tops)

ACCESSORIES | ROUND GROMMET, HOOK, WIRE MANAGEMENT (SEE PRIMEWAY ACCESSORIES PAGE FOR: POWER DATA OPTIONS)



Model#	Accessory Option	List Price
TFG	Round Grommet (Black, Grey, White)	\$25
UBH	Black Hook, Undermount (near edge)	\$35
WMH	Wire Management Holes (2) in 1 vertical column specify base & column(s) (based on site conditions)	\$75

*SPECIFY EXACT LOCATION FOR ANY ABOVE OPTION

14 SHAPES | RECTANGLE, RACETRACK, WEDGE, BOAT, BULLET, SOFT WEDGE, SOFT PENTAGON, BOAT-R, DIAMOND, BOW END, MEDIA PEAR, MEDIA WEDGE, MEDIA SHARE, OVAL

- 44 Standard HPL Finishes
- 3 Edge Options
- Top Thickness 1-1/4" (+/- based on edge detail)
- 1 Piece Tops up to 108", 2 Piece Tops 120" - 180", 3 Piece Tops 192" - 240"
(Alignment of woodgrain patterns with 2 & 3 piece tops cannot be guaranteed, draw-tight hardware & wafers are included for installation)
- Stiffener Bars Included with Tables 84" & Up

See "Primeway Standard Color Card" for All Finish Specifications & Swatches





OPTIONAL:
Decorative Foot Extension in Black.
Add \$95.00 List- Per Double Leg.
Consult factory for other colors.

Standard Features:

- Adjustable leveling glides included.
- Power/Data options available, see Power/Data Solutions page.
- Wire management, grommets, etc. available, consult factory.

(*) = 2-Piece Top. (**) = 3-Piece Top Spline & Joint Fasteners included with table.

NOTE: Woodgrain pattern alignment between multiple tops not guaranteed.

HPL TOPS | 44 standard HPL finishes

METAL BASES | 11 powder coat finishes

EDGES | matching & coordinating finishes in the following options:

ABS 1: PVC-free impact resistant flat edge (S)

ABS 2: Multi-Ply "Plywood Look" flat vinyl edge (M)

ABS 3: Knife (KV), 1/2" Flat edge- bevel painted in a companion color

- Refer to edge code, above in (), when pricing below -

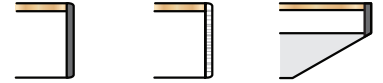

SIZE	BASE INFO #, Style	MODEL #	ABS 1 S	ABS 2 M	ABS 3 KV	
WIDTH 42" HEIGHT 29"						
	42 x 72 x 29	(2) Y	DCXL4272SQ	\$2,397	\$2,575	\$2,797
	42 x 84 x 29	(2) Y	DCXL4284SQ	\$2,646	\$2,855	\$3,116
	42 x 96 x 29	(2) Y	DCXL4296SQ	\$2,885	\$3,099	\$3,369

• For additional table sizes at 42" wide, use 48" wide sizes/pricing below- specify model # accordingly: (42" x 144" x 29" = DCXL42144SQ)

WIDTH 48" HEIGHT 29"						
	48 x 84 x 29	(2) Y	DCXL4884SQ	\$3,057	\$3,263	\$3,520
	48 x 96 x 29	(2) Y	DCXL4896SQ	\$3,231	\$3,455	\$3,736
	48 x 108 x 29	(2) Y	DCXL48108SQ	\$3,879	\$4,122	\$4,426
	* 48 x 120 x 29	(2) Y / (1) T	DCXL48120SQ	\$4,789	\$5,050	\$5,378
	* 48 x 144 x 29	(2) Y / (1) T	DCXL48144SQ	\$5,212	\$5,511	\$5,886
	* 48 x 156 x 29	(2) Y / (2) T	DCXL48156SQ	\$6,372	\$6,690	\$7,088
	* 48 x 168 x 29	(2) Y / (2) T	DCXL48168SQ	\$6,419	\$6,755	\$7,176
	* 48 x 180 x 29	(2) Y / (2) T	DCXL48180SQ	\$6,763	\$7,118	\$7,563
	** 48 x 192 x 29	(2) Y / (3) T	DCXL48192SQ	\$7,632	\$8,006	\$8,474
	** 48 x 204 x 29	(2) Y / (3) T	DCXL48204SQ	\$8,041	\$8,433	\$8,925
	** 48 x 216 x 29	(2) Y / (4) T	DCXL48216SQ	\$8,086	\$8,496	\$9,010
	** 48 x 228 x 29	(2) Y / (4) T	DCXL48228SQ	\$8,637	\$9,067	\$9,605
	** 48 x 240 x 29	(2) Y / (4) T	DCXL48240SQ	\$9,050	\$9,499	\$10,060

WIDTH 54" | HEIGHT 29" Use 60" wide sizes/pricing below- specify model # accordingly: (54" x 96" x 29" = DCXL5496SQ)

WIDTH 60" HEIGHT 29"						
	60 x 84 x 29	(2) Y	DCXL6084SQ	\$3,515	\$3,739	\$4,139
	60 x 96 x 29	(2) Y	DCXL6096SQ	\$3,796	\$4,039	\$4,473
	60 x 108 x 29	(2) Y	DCXL60108SQ	\$4,491	\$4,753	\$5,219
	* 60 x 120 x 29	(2) Y / (1) T	DCXL60120SQ	\$5,209	\$5,489	\$5,989
	* 60 x 144 x 29	(2) Y / (1) T	DCXL60144SQ	\$5,583	\$5,901	\$6,468
	* 60 x 156 x 29	(2) Y / (2) T	DCXL60156SQ	\$6,807	\$7,143	\$7,744
	* 60 x 168 x 29	(2) Y / (2) T	DCXL60168SQ	\$6,994	\$7,350	\$7,983
	* 60 x 180 x 29	(2) Y / (2) T	DCXL60180SQ	\$7,276	\$7,650	\$8,317
	** 60 x 192 x 29	(2) Y / (3) T	DCXL60192SQ	\$8,286	\$8,678	\$9,378
	** 60 x 204 x 29	(2) Y / (3) T	DCXL60204SQ	\$8,628	\$9,039	\$9,773
	** 60 x 216 x 29	(2) Y / (4) T	DCXL60216SQ	\$8,816	\$9,246	\$10,013
	** 60 x 228 x 29	(2) Y / (4) T	DCXL60228SQ	\$9,302	\$9,751	\$10,551
	** 60 x 240 x 29	(2) Y / (4) T	DCXL60240SQ	\$9,858	\$10,325	\$11,159



OPTIONAL:
Decorative Foot Extension in Black.
Add \$95.00 List- Per Double Leg.
Consult factory for other colors.

Standard Features:

- Adjustable leveling glides included.
- Power/Data options available, see Power/Data Solutions page.
- Wire management, grommets, etc. available, consult factory.

(*) = 2-Piece Top. (**) = 3-Piece Top Spline & Joint Fasteners included with table.

NOTE: Woodgrain pattern alignment between multiple tops not guaranteed.

HPL TOPS | 44 standard HPL finishes

METAL BASES | 11 powder coat finishes

EDGES | matching & coordinating finishes in the following options:

ABS 1: PVC-free impact resistant flat edge (S)

ABS 2: Multi-Ply "Plywood Look" flat vinyl edge (M)

ABS 3: Knife (KV), 1/2" Flat edge- bevel painted in a companion color

- Refer to edge code, above in (), when pricing below -

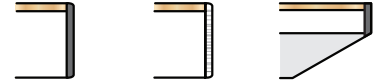

SIZE	BASE INFO #, Style	MODEL #	ABS 1 S	ABS 2 M	ABS 3 KV	
WIDTH 42" HEIGHT 42"						
	42 x 72 x 42	(2) Y	DCXL427242SQ	\$2,771	\$2,949	\$3,171
	42 x 84 x 42	(2) Y	DCXL428442SQ	\$3,020	\$3,229	\$3,490
	42 x 96 x 42	(2) Y	DCXL429642SQ	\$3,258	\$3,473	\$3,742

• For additional tables at 42" wide, use 48" wide sizes/pricing below- specify model # accordingly: (42" x 144" x 42" = DCXL4214442SQ)

WIDTH 48" HEIGHT 42"						
	48 x 84 x 42	(2) Y	DCXL488442SQ	\$3,431	\$3,636	\$3,894
	48 x 96 x 42	(2) Y	DCXL489642SQ	\$3,604	\$3,829	\$4,109
	48 x 108 x 42	(2) Y	DCXL4810842SQ	\$4,252	\$4,495	\$4,800
	* 48 x 120 x 42	(2) Y / (1) T	DCXL4812042SQ	\$5,349	\$5,611	\$5,939
	* 48 x 144 x 42	(2) Y / (1) T	DCXL4814442SQ	\$5,773	\$6,072	\$6,446
	* 48 x 156 x 42	(2) Y / (2) T	DCXL4815642SQ	\$7,120	\$7,438	\$7,835
	* 48 x 168 x 42	(2) Y / (2) T	DCXL4816842SQ	\$7,166	\$7,503	\$7,924
	* 48 x 180 x 42	(2) Y / (2) T	DCXL4818042SQ	\$7,510	\$7,865	\$8,310
	** 48 x 192 x 42	(2) Y / (3) T	DCXL4819242SQ	\$8,567	\$8,940	\$9,408
	** 48 x 204 x 42	(2) Y / (3) T	DCXL4820442SQ	\$8,975	\$9,368	\$9,859
	** 48 x 216 x 42	(2) Y / (4) T	DCXL4821642SQ	\$9,021	\$9,431	\$9,945
	** 48 x 228 x 42	(2) Y / (4) T	DCXL4822842SQ	\$9,572	\$10,001	\$10,540
	** 48 x 240 x 42	(2) Y / (4) T	DCXL4824042SQ	\$9,985	\$10,433	\$10,995

WIDTH 54" | HEIGHT 42" Use 60" wide sizes/pricing below- specify model # accordingly: (54" x 96" x 42" = DCXL549642SQ)

WIDTH 60" HEIGHT 42"						
	60 x 84 x 42	(2) Y	DCXL608442SQ	\$3,889	\$4,113	\$4,513
	60 x 96 x 42	(2) Y	DCXL609642SQ	\$4,170	\$4,413	\$4,847
	60 x 108 x 42	(2) Y	DCXL6010842SQ	\$4,865	\$5,126	\$5,593
	* 60 x 120 x 42	(2) Y / (1) T	DCXL6012042SQ	\$5,769	\$6,050	\$6,550
	* 60 x 144 x 42	(2) Y / (1) T	DCXL6014442SQ	\$6,144	\$6,462	\$7,029
	* 60 x 156 x 42	(2) Y / (2) T	DCXL6015642SQ	\$7,555	\$7,891	\$8,491
	* 60 x 168 x 42	(2) Y / (2) T	DCXL6016842SQ	\$7,742	\$8,097	\$8,731
	* 60 x 180 x 42	(2) Y / (2) T	DCXL6018042SQ	\$8,024	\$8,397	\$9,064
	** 60 x 192 x 42	(2) Y / (3) T	DCXL6019242SQ	\$9,220	\$9,613	\$10,313
	** 60 x 204 x 42	(2) Y / (3) T	DCXL6020442SQ	\$9,563	\$9,974	\$10,708
	** 60 x 216 x 42	(2) Y / (4) T	DCXL6021642SQ	\$9,750	\$10,180	\$10,947
	** 60 x 228 x 42	(2) Y / (4) T	DCXL6022842SQ	\$10,237	\$10,685	\$11,486
	** 60 x 240 x 42	(2) Y / (4) T	DCXL6024042SQ	\$10,792	\$11,259	\$12,093

• To specify 36" high tables, use 42" high sizes/pricing above & adjust model # accordingly: (60" x 84" x 36" = DCXL608436SQ)



OPTIONAL:
Decorative Foot Extension in Black.
Add \$95.00 List- Per Double Leg.
Consult factory for other colors.

Standard Features:

- Adjustable leveling glides included.
- Power/Data options available, see Power/Data Solutions page.
- Wire management, grommets, etc. available, consult factory.

(*) = 2-Piece Top. (**) = 3-Piece Top Spline & Joint Fasteners included with table.

NOTE: Woodgrain pattern alignment between multiple tops not guaranteed.

HPL TOPS | 44 standard HPL finishes

METAL BASES | 11 powder coat finishes

EDGES | matching & coordinating finishes in the following options:

ABS 1: PVC-free impact resistant flat edge (S)

ABS 2: Multi-Ply "Plywood Look" flat vinyl edge (M)

ABS 3: Knife (KV), 1/2" Flat edge- bevel painted in a companion color

- Refer to edge code, above in (), when pricing below -

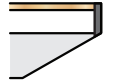

SIZE	BASE INFO #, Style	MODEL #	ABS 1 S	ABS 2 M	ABS 3 KV	
WIDTH 42" HEIGHT 29"						
	42 x 72 x 29	(2) Y	DCXL4272WD	\$2,656	\$2,834	\$3,056
	42 x 84 x 29	(2) Y	DCXL4284WD	\$2,905	\$3,114	\$3,375
	42 x 96 x 29	(2) Y	DCXL4296WD	\$3,143	\$3,358	\$3,627

• For additional table sizes at 42" wide, use 48" wide sizes/pricing below- specify model # accordingly: (42" x 144" x 29" = DCXL42144WD)

SIZE	BASE INFO #, Style	MODEL #	ABS 1 S	ABS 2 M	ABS 3 KV	
WIDTH 48" HEIGHT 29"						
	48 x 84 x 29	(2) Y	DCXL4884WD	\$3,316	\$3,521	\$3,779
	48 x 96 x 29	(2) Y	DCXL4896WD	\$3,489	\$3,714	\$3,994
	48 x 108 x 29	(2) Y	DCXL48108WD	\$4,137	\$4,380	\$4,685
	* 48 x 120 x 29	(2) Y / (1) T	DCXL48120WD	\$5,162	\$5,424	\$5,752
	* 48 x 144 x 29	(2) Y / (1) T	DCXL48144WD	\$5,586	\$5,885	\$6,260
	* 48 x 156 x 29	(2) Y / (2) T	DCXL48156WD	\$6,746	\$7,064	\$7,462
	* 48 x 168 x 29	(2) Y / (2) T	DCXL48168WD	\$6,793	\$7,129	\$7,550
	* 48 x 180 x 29	(2) Y / (2) T	DCXL48180WD	\$7,137	\$7,492	\$7,936
	** 48 x 192 x 29	(2) Y / (3) T	DCXL48192WD	\$8,006	\$8,380	\$8,848
	** 48 x 204 x 29	(2) Y / (3) T	DCXL48204WD	\$8,415	\$8,807	\$9,299
	** 48 x 216 x 29	(2) Y / (4) T	DCXL48216WD	\$8,460	\$8,870	\$9,384
	** 48 x 228 x 29	(2) Y / (4) T	DCXL48228WD	\$9,126	\$9,556	\$10,094
	** 48 x 240 x 29	(2) Y / (4) T	DCXL48240WD	\$9,539	\$9,988	\$10,549

WIDTH 54" | HEIGHT 29" Use 60" wide sizes/pricing below- specify model # accordingly: (54" x 96" x 29" = DCXL5496WD)

SIZE	BASE INFO #, Style	MODEL #	ABS 1 S	ABS 2 M	ABS 3 KV	
WIDTH 60" HEIGHT 29"						
	60 x 84 x 29	(2) Y	DCXL6084WD	\$3,774	\$3,998	\$4,398
	60 x 96 x 29	(2) Y	DCXL6096WD	\$4,055	\$4,298	\$4,732
	60 x 108 x 29	(2) Y	DCXL60108WD	\$4,750	\$5,011	\$5,478
	* 60 x 120 x 29	(2) Y / (1) T	DCXL60120WD	\$5,582	\$5,863	\$6,363
	* 60 x 144 x 29	(2) Y / (1) T	DCXL60144WD	\$5,957	\$6,275	\$6,842
	* 60 x 156 x 29	(2) Y / (2) T	DCXL60156WD	\$7,181	\$7,517	\$8,117
	* 60 x 168 x 29	(2) Y / (2) T	DCXL60168WD	\$7,368	\$7,723	\$8,357
	* 60 x 180 x 29	(2) Y / (2) T	DCXL60180WD	\$7,650	\$8,024	\$8,691
	** 60 x 192 x 29	(2) Y / (3) T	DCXL60192WD	\$8,659	\$9,052	\$9,752
	** 60 x 204 x 29	(2) Y / (3) T	DCXL60204WD	\$9,002	\$9,413	\$10,147
	** 60 x 216 x 29	(2) Y / (4) T	DCXL60216WD	\$9,189	\$9,619	\$10,386
	** 60 x 228 x 29	(2) Y / (4) T	DCXL60228WD	\$9,791	\$10,240	\$11,040
	** 60 x 240 x 29	(2) Y / (4) T	DCXL60240WD	\$10,347	\$10,814	\$11,647



OPTIONAL:
Decorative Foot Extension in Black.
Add \$95.00 List- Per Double Leg.
Consult factory for other colors.

Standard Features:

- Adjustable leveling glides included.
 - Power/Data options available, see Power/Data Solutions page.
 - Wire management, grommets, etc. available, consult factory.
 - (*) = 2-Piece Top. (**) = 3-Piece Top Spline & Joint Fasteners included with table.
- NOTE: Woodgrain pattern alignment between multiple tops not guaranteed.

HPL TOPS | 44 standard HPL finishes

METAL BASES | 11 powder coat finishes

EDGES | matching & coordinating finishes in the following options:

ABS 1: PVC-free impact resistant flat edge (S)

ABS 2: Multi-Ply "Plywood Look" flat vinyl edge (M)

ABS 3: Knife (KV), 1/2" Flat edge- bevel painted in a companion color

- Refer to edge code, above in (), when pricing below -

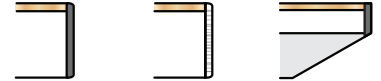

SIZE	BASE INFO #, Style	MODEL #	ABS 1 S	ABS 2 M	ABS 3 KV	
WIDTH 42" HEIGHT 42"						
	42 x 72 x 42	(2) Y	DCXL427242WD	\$3,030	\$3,207	\$3,430
	42 x 84 x 42	(2) Y	DCXL428442WD	\$3,279	\$3,488	\$3,749
	42 x 96 x 42	(2) Y	DCXL429642WD	\$3,517	\$3,732	\$4,001

• For additional tables at 42" wide, use 48" wide sizes/pricing below- specify model # accordingly: (42" x 144" x 42" = DCXL4214442WD)

WIDTH 48" HEIGHT 42"						
	48 x 84 x 42	(2) Y	DCXL488442WD	\$3,690	\$3,895	\$4,153
	48 x 96 x 42	(2) Y	DCXL489642WD	\$3,863	\$4,087	\$4,368
	48 x 108 x 42	(2) Y	DCXL4810842WD	\$4,511	\$4,754	\$5,058
	* 48 x 120 x 42	(2) Y / (1) T	DCXL4812042WD	\$5,723	\$5,985	\$6,312
	* 48 x 144 x 42	(2) Y / (1) T	DCXL4814442WD	\$6,147	\$6,446	\$6,820
	* 48 x 156 x 42	(2) Y / (2) T	DCXL4815642WD	\$7,494	\$7,811	\$8,209
	* 48 x 168 x 42	(2) Y / (2) T	DCXL4816842WD	\$7,540	\$7,876	\$8,298
	* 48 x 180 x 42	(2) Y / (2) T	DCXL4818042WD	\$7,884	\$8,239	\$8,684
	** 48 x 192 x 42	(2) Y / (3) T	DCXL4819242WD	\$8,940	\$9,314	\$9,782
	** 48 x 204 x 42	(2) Y / (3) T	DCXL4820442WD	\$9,349	\$9,742	\$10,233
	** 48 x 216 x 42	(2) Y / (4) T	DCXL4821642WD	\$9,394	\$9,805	\$10,319
	** 48 x 228 x 42	(2) Y / (4) T	DCXL4822842WD	\$10,060	\$10,490	\$11,028
	** 48 x 240 x 42	(2) Y / (4) T	DCXL4824042WD	\$10,473	\$10,922	\$11,484

WIDTH 54" | HEIGHT 42" Use 60" wide sizes/pricing below- specify model # accordingly: (54" x 96" x 42" = DCXL549642WD)

WIDTH 60" HEIGHT 42"						
	60 x 84 x 42	(2) Y	DCXL608442WD	\$4,147	\$4,372	\$4,772
	60 x 96 x 42	(2) Y	DCXL609642WD	\$4,429	\$4,672	\$5,105
	60 x 108 x 42	(2) Y	DCXL6010842WD	\$5,123	\$5,385	\$5,852
	* 60 x 120 x 42	(2) Y / (1) T	DCXL6012042WD	\$6,143	\$6,423	\$6,924
	* 60 x 144 x 42	(2) Y / (1) T	DCXL6014442WD	\$6,518	\$6,836	\$7,402
	* 60 x 156 x 42	(2) Y / (2) T	DCXL6015642WD	\$7,928	\$8,265	\$8,865
	* 60 x 168 x 42	(2) Y / (2) T	DCXL6016842WD	\$8,116	\$8,471	\$9,104
	* 60 x 180 x 42	(2) Y / (2) T	DCXL6018042WD	\$8,397	\$8,771	\$9,438
	** 60 x 192 x 42	(2) Y / (3) T	DCXL6019242WD	\$9,594	\$9,986	\$10,687
	** 60 x 204 x 42	(2) Y / (3) T	DCXL6020442WD	\$9,936	\$10,348	\$11,081
	** 60 x 216 x 42	(2) Y / (4) T	DCXL6021642WD	\$10,124	\$10,554	\$11,321
	** 60 x 228 x 42	(2) Y / (4) T	DCXL6022842WD	\$10,726	\$11,174	\$11,974
	** 60 x 240 x 42	(2) Y / (4) T	DCXL6024042WD	\$11,281	\$11,748	\$12,582

• To specify 36" high tables, use 42" high sizes/pricing above & adjust model # accordingly: (60" x 84" x 36" = DCXL608436WD)



OPTIONAL:
Decorative Foot Extension in Black.
Add \$95.00 List- Per Double Leg.
Consult factory for other colors.

Standard Features:

- Adjustable leveling glides included.
- Power/Data options available, see Power/Data Solutions page.
- Wire management, grommets, etc. available, consult factory.

(*) = 2-Piece Top. (**) = 3-Piece Top Spline & Joint Fasteners included with table.

NOTE: Woodgrain pattern alignment between multiple tops not guaranteed.

HPL TOPS | 44 standard HPL finishes

METAL BASES | 11 powder coat finishes

EDGES | matching & coordinating finishes in the following options:

ABS 1: PVC-free impact resistant flat edge (S)

ABS 2: Multi-Ply "Plywood Look" flat vinyl edge (M)

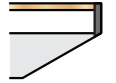

ABS 3: Knife (KV), 1/2" Flat edge- bevel painted in a companion color

- Refer to edge code, above in (), when pricing below -



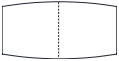

SIZE	BASE INFO #, Style	MODEL #	ABS 1 S	ABS 2 M	ABS 3 KV	
WIDTH 42" HEIGHT 29"						
	42 x 72 x 29	(2) Y	DCXL4272BT	\$2,656	\$2,834	\$3,056
	42 x 84 x 29	(2) Y	DCXL4284BT	\$2,905	\$3,114	\$3,375
	42 x 96 x 29	(2) Y	DCXL4296BT	\$3,143	\$3,358	\$3,627

• For additional table sizes at 42" wide, use 48" wide sizes/pricing below- specify model # accordingly: (42" x 144" x 29" = DCXL42144BT)

SIZE	BASE INFO #, Style	MODEL #	ABS 1 S	ABS 2 M	ABS 3 KV	
WIDTH 48" HEIGHT 29"						
	48 x 84 x 29	(2) Y	DCXL4884BT	\$3,316	\$3,521	\$3,779
	48 x 96 x 29	(2) Y	DCXL4896BT	\$3,489	\$3,714	\$3,994
	48 x 108 x 29	(2) Y	DCXL48108BT	\$4,137	\$4,380	\$4,685
	* 48 x 120 x 29	(2) Y / (1) T	DCXL48120BT	\$5,162	\$5,424	\$5,752
	* 48 x 144 x 29	(2) Y / (1) T	DCXL48144BT	\$5,586	\$5,885	\$6,260
	* 48 x 156 x 29	(2) Y / (2) T	DCXL48156BT	\$6,746	\$7,064	\$7,462
	* 48 x 168 x 29	(2) Y / (2) T	DCXL48168BT	\$6,793	\$7,129	\$7,550
	* 48 x 180 x 29	(2) Y / (2) T	DCXL48180BT	\$7,137	\$7,492	\$7,936
	** 48 x 192 x 29	(2) Y / (3) T	DCXL48192BT	\$8,006	\$8,380	\$8,848
	** 48 x 204 x 29	(2) Y / (3) T	DCXL48204BT	\$8,415	\$8,807	\$9,299
	** 48 x 216 x 29	(2) Y / (4) T	DCXL48216BT	\$8,460	\$8,870	\$9,384
	** 48 x 228 x 29	(2) Y / (4) T	DCXL48228BT	\$9,126	\$9,556	\$10,094
	** 48 x 240 x 29	(2) Y / (4) T	DCXL48240BT	\$9,539	\$9,988	\$10,549

WIDTH 54" | HEIGHT 29" Use 60" wide sizes/pricing below- specify model # accordingly: (54" x 96" x 29" = DCXL5496BT)

SIZE	BASE INFO #, Style	MODEL #	ABS 1 S	ABS 2 M	ABS 3 KV	
WIDTH 60" HEIGHT 29"						
	60 x 84 x 29	(2) Y	DCXL6084BT	\$3,774	\$3,998	\$4,398
	60 x 96 x 29	(2) Y	DCXL6096BT	\$4,055	\$4,298	\$4,732
	60 x 108 x 29	(2) Y	DCXL60108BT	\$4,750	\$5,011	\$5,478
	* 60 x 120 x 29	(2) Y / (1) T	DCXL60120BT	\$5,582	\$5,863	\$6,363
	* 60 x 144 x 29	(2) Y / (1) T	DCXL60144BT	\$5,957	\$6,275	\$6,842
	* 60 x 156 x 29	(2) Y / (2) T	DCXL60156BT	\$7,181	\$7,517	\$8,117
	* 60 x 168 x 29	(2) Y / (2) T	DCXL60168BT	\$7,368	\$7,723	\$8,357
	* 60 x 180 x 29	(2) Y / (2) T	DCXL60180BT	\$7,650	\$8,024	\$8,691
	** 60 x 192 x 29	(2) Y / (3) T	DCXL60192BT	\$8,659	\$9,052	\$9,752
	** 60 x 204 x 29	(2) Y / (3) T	DCXL60204BT	\$9,002	\$9,413	\$10,147
	** 60 x 216 x 29	(2) Y / (4) T	DCXL60216BT	\$9,189	\$9,619	\$10,386
	** 60 x 228 x 29	(2) Y / (4) T	DCXL60228BT	\$9,791	\$10,240	\$11,040
	** 60 x 240 x 29	(2) Y / (4) T	DCXL60240BT	\$10,347	\$10,814	\$11,647



OPTIONAL:
Decorative Foot Extension in Black.
Add \$95.00 List- Per Double Leg.
Consult factory for other colors.

Standard Features:

- Adjustable leveling glides included.
- Power/Data options available, see Power/Data Solutions page.
- Wire management, grommets, etc. available, consult factory.

(*) = 2-Piece Top. (**) = 3-Piece Top Spline & Joint Fasteners included with table.

NOTE: Woodgrain pattern alignment between multiple tops not guaranteed.

HPL TOPS | 44 standard HPL finishes

METAL BASES | 11 powder coat finishes

EDGES | matching & coordinating finishes in the following options:

ABS 1: PVC-free impact resistant flat edge (S)

ABS 2: Multi-Ply "Plywood Look" flat vinyl edge (M)

ABS 3: Knife (KV), 1/2" Flat edge- bevel painted in a companion color

- Refer to edge code, above in (), when pricing below -

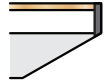

SIZE	BASE INFO #, Style	MODEL #	ABS 1 S	ABS 2 M	ABS 3 KV	
WIDTH 42" HEIGHT 42"						
	42 x 72 x 42	(2) Y	DCXL427242BT	\$3,030	\$3,207	\$3,430
	42 x 84 x 42	(2) Y	DCXL428442BT	\$3,279	\$3,488	\$3,749
	42 x 96 x 42	(2) Y	DCXL429642BT	\$3,517	\$3,732	\$4,001

• For additional tables at 42" wide, use 48" wide sizes/pricing below- specify model # accordingly: (42" x 144" x 42" = DCXL4214442BT)

SIZE	BASE INFO #, Style	MODEL #	ABS 1 S	ABS 2 M	ABS 3 KV	
WIDTH 48" HEIGHT 42"						
	48 x 84 x 42	(2) Y	DCXL488442BT	\$3,690	\$3,895	\$4,153
	48 x 96 x 42	(2) Y	DCXL489642BT	\$3,863	\$4,087	\$4,368
	48 x 108 x 42	(2) Y	DCXL4810842BT	\$4,511	\$4,754	\$5,058
	* 48 x 120 x 42	(2) Y / (1) T	DCXL4812042BT	\$5,723	\$5,985	\$6,312
	* 48 x 144 x 42	(2) Y / (1) T	DCXL4814442BT	\$6,147	\$6,446	\$6,820
	* 48 x 156 x 42	(2) Y / (2) T	DCXL4815642BT	\$7,494	\$7,811	\$8,209
	* 48 x 168 x 42	(2) Y / (2) T	DCXL4816842BT	\$7,540	\$7,876	\$8,298
	* 48 x 180 x 42	(2) Y / (2) T	DCXL4818042BT	\$7,884	\$8,239	\$8,684
	** 48 x 192 x 42	(2) Y / (3) T	DCXL4819242BT	\$8,940	\$9,314	\$9,782
	** 48 x 204 x 42	(2) Y / (3) T	DCXL4820442BT	\$9,349	\$9,742	\$10,233
	** 48 x 216 x 42	(2) Y / (4) T	DCXL4821642BT	\$9,394	\$9,805	\$10,319
	** 48 x 228 x 42	(2) Y / (4) T	DCXL4822842BT	\$10,060	\$10,490	\$11,028
	** 48 x 240 x 42	(2) Y / (4) T	DCXL4824042BT	\$10,473	\$10,922	\$11,484

WIDTH 54" | HEIGHT 42" Use 60" wide sizes/pricing below- specify model # accordingly: (54" x 96" x 42" = DCXL549642BT)

SIZE	BASE INFO #, Style	MODEL #	ABS 1 S	ABS 2 M	ABS 3 KV	
WIDTH 60" HEIGHT 42"						
	60 x 84 x 42	(2) Y	DCXL608442BT	\$4,147	\$4,372	\$4,772
	60 x 96 x 42	(2) Y	DCXL609642BT	\$4,429	\$4,672	\$5,105
	60 x 108 x 42	(2) Y	DCXL6010842BT	\$5,123	\$5,385	\$5,852
	* 60 x 120 x 42	(2) Y / (1) T	DCXL6012042BT	\$6,143	\$6,423	\$6,924
	* 60 x 144 x 42	(2) Y / (1) T	DCXL6014442BT	\$6,518	\$6,836	\$7,402
	* 60 x 156 x 42	(2) Y / (2) T	DCXL6015642BT	\$7,928	\$8,265	\$8,865
	* 60 x 168 x 42	(2) Y / (2) T	DCXL6016842BT	\$8,116	\$8,471	\$9,104
	* 60 x 180 x 42	(2) Y / (2) T	DCXL6018042BT	\$8,397	\$8,771	\$9,438
	** 60 x 192 x 42	(2) Y / (3) T	DCXL6019242BT	\$9,594	\$9,986	\$10,687
	** 60 x 204 x 42	(2) Y / (3) T	DCXL6020442BT	\$9,936	\$10,348	\$11,081
	** 60 x 216 x 42	(2) Y / (4) T	DCXL6021642BT	\$10,124	\$10,554	\$11,321
	** 60 x 228 x 42	(2) Y / (4) T	DCXL6022842BT	\$10,726	\$11,174	\$11,974
	** 60 x 240 x 42	(2) Y / (4) T	DCXL6024042BT	\$11,281	\$11,748	\$12,582

• To specify 36" high tables, use 42" high sizes/pricing above & adjust model # accordingly: (60" x 84" x 36" = DCXL608436BT)



OPTIONAL:
Decorative Foot Extension in Black.
Add \$95.00 List- Per Double Leg.
Consult factory for other colors.

Standard Features:

- Adjustable leveling glides included.
- Power/Data options available, see Power/Data Solutions page.
- Wire management, grommets, etc. available, consult factory.

(*) = 2-Piece Top. (**) = 3-Piece Top Spline & Joint Fasteners included with table.

NOTE: Woodgrain pattern alignment between multiple tops not guaranteed.

HPL TOPS | 44 standard HPL finishes

METAL BASES | 11 powder coat finishes

EDGES | matching & coordinating finishes in the following options:

ABS 1: PVC-free impact resistant flat edge (S)

ABS 2: Multi-Ply "Plywood Look" flat vinyl edge (M)

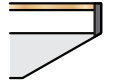

ABS 3: Knife (KV), 1/2" Flat edge- bevel painted in a companion color

- Refer to edge code, above in (), when pricing below -





SIZE	BASE INFO #, Style	MODEL #	ABS 1 S	ABS 2 M	ABS 3 KV	
WIDTH 42" HEIGHT 29"						
	42 x 72 x 29	(2) Y	DCXL4272DM	\$2,656	\$2,834	\$3,056
	42 x 84 x 29	(2) Y	DCXL4284DM	\$2,905	\$3,114	\$3,375
	42 x 96 x 29	(2) Y	DCXL4296DM	\$3,143	\$3,358	\$3,627

• For additional table sizes at 42" wide, use 48" wide sizes/pricing below- specify model # accordingly: (42" x 144" x 29" = DCXL42144DM)

SIZE	BASE INFO #, Style	MODEL #	ABS 1 S	ABS 2 M	ABS 3 KV	
WIDTH 48" HEIGHT 29"						
	48 x 84 x 29	(2) Y	DCXL4884DM	\$3,316	\$3,521	\$3,779
	48 x 96 x 29	(2) Y	DCXL4896DM	\$3,489	\$3,714	\$3,994
	48 x 108 x 29	(2) Y	DCXL48108DM	\$4,137	\$4,380	\$4,685
	* 48 x 120 x 29	(2) Y / (1) T	DCXL48120DM	\$5,162	\$5,424	\$5,752
	* 48 x 144 x 29	(2) Y / (1) T	DCXL48144DM	\$5,586	\$5,885	\$6,260
	* 48 x 156 x 29	(2) Y / (2) T	DCXL48156DM	\$6,746	\$7,064	\$7,462
	* 48 x 168 x 29	(2) Y / (2) T	DCXL48168DM	\$6,793	\$7,129	\$7,550
	* 48 x 180 x 29	(2) Y / (2) T	DCXL48180DM	\$7,137	\$7,492	\$7,936
	** 48 x 192 x 29	(2) Y / (3) T	DCXL48192DM	\$8,006	\$8,380	\$8,848
	** 48 x 204 x 29	(2) Y / (3) T	DCXL48204DM	\$8,415	\$8,807	\$9,299
	** 48 x 216 x 29	(2) Y / (4) T	DCXL48216DM	\$8,460	\$8,870	\$9,384
	** 48 x 228 x 29	(2) Y / (4) T	DCXL48228DM	\$9,126	\$9,556	\$10,094
	** 48 x 240 x 29	(2) Y / (4) T	DCXL48240DM	\$9,539	\$9,988	\$10,549

WIDTH 54" | HEIGHT 29" Use 60" wide sizes/pricing below- specify model # accordingly: (54" x 96" x 29" = DCXL5496DM)

SIZE	BASE INFO #, Style	MODEL #	ABS 1 S	ABS 2 M	ABS 3 KV	
WIDTH 60" HEIGHT 29"						
	60 x 84 x 29	(2) Y	DCXL6084DM	\$3,774	\$3,998	\$4,398
	60 x 96 x 29	(2) Y	DCXL6096DM	\$4,055	\$4,298	\$4,732
	60 x 108 x 29	(2) Y	DCXL60108DM	\$4,750	\$5,011	\$5,478
	* 60 x 120 x 29	(2) Y / (1) T	DCXL60120DM	\$5,582	\$5,863	\$6,363
	* 60 x 144 x 29	(2) Y / (1) T	DCXL60144DM	\$5,957	\$6,275	\$6,842
	* 60 x 156 x 29	(2) Y / (2) T	DCXL60156DM	\$7,181	\$7,517	\$8,117
	* 60 x 168 x 29	(2) Y / (2) T	DCXL60168DM	\$7,368	\$7,723	\$8,357
	* 60 x 180 x 29	(2) Y / (2) T	DCXL60180DM	\$7,650	\$8,024	\$8,691
	** 60 x 192 x 29	(2) Y / (3) T	DCXL60192DM	\$8,659	\$9,052	\$9,752
	** 60 x 204 x 29	(2) Y / (3) T	DCXL60204DM	\$9,002	\$9,413	\$10,147
	** 60 x 216 x 29	(2) Y / (4) T	DCXL60216DM	\$9,189	\$9,619	\$10,386
	** 60 x 228 x 29	(2) Y / (4) T	DCXL60228DM	\$9,791	\$10,240	\$11,040
	** 60 x 240 x 29	(2) Y / (4) T	DCXL60240DM	\$10,347	\$10,814	\$11,647



OPTIONAL:
Decorative Foot Extension in Black.
Add \$95.00 List- Per Double Leg.
Consult factory for other colors.

Standard Features:

- Adjustable leveling glides included.
- Power/Data options available, see Power/Data Solutions page.
- Wire management, grommets, etc. available, consult factory.

(*) = 2-Piece Top. (**) = 3-Piece Top Spline & Joint Fasteners included with table.

NOTE: Woodgrain pattern alignment between multiple tops not guaranteed.

HPL TOPS | 44 standard HPL finishes

METAL BASES | 11 powder coat finishes

EDGES | matching & coordinating finishes in the following options:

ABS 1: PVC-free impact resistant flat edge (S)

ABS 2: Multi-Ply "Plywood Look" flat vinyl edge (M)

ABS 3: Knife (KV), 1/2" Flat edge- bevel painted in a companion color

- Refer to edge code, above in (), when pricing below -

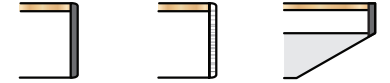

SIZE	BASE INFO #, Style	MODEL #	ABS 1 S	ABS 2 M	ABS 3 KV	
WIDTH 42" HEIGHT 42"						
	42 x 72 x 42	(2) Y	DCXL427242DM	\$3,030	\$3,207	\$3,430
	42 x 84 x 42	(2) Y	DCXL428442DM	\$3,279	\$3,488	\$3,749
	42 x 96 x 42	(2) Y	DCXL429642DM	\$3,517	\$3,732	\$4,001

• For additional tables at 42" wide, use 48" wide sizes/pricing below- specify model # accordingly: (42" x 144" x 42" = DCXL4214442DM)

SIZE	BASE INFO #, Style	MODEL #	ABS 1 S	ABS 2 M	ABS 3 KV	
WIDTH 48" HEIGHT 42"						
	48 x 84 x 42	(2) Y	DCXL488442DM	\$3,690	\$3,895	\$4,153
	48 x 96 x 42	(2) Y	DCXL489642DM	\$3,863	\$4,087	\$4,368
	48 x 108 x 42	(2) Y	DCXL4810842DM	\$4,511	\$4,754	\$5,058
	* 48 x 120 x 42	(2) Y / (1) T	DCXL4812042DM	\$5,723	\$5,985	\$6,312
	* 48 x 144 x 42	(2) Y / (1) T	DCXL4814442DM	\$6,147	\$6,446	\$6,820
	* 48 x 156 x 42	(2) Y / (2) T	DCXL4815642DM	\$7,494	\$7,811	\$8,209
	* 48 x 168 x 42	(2) Y / (2) T	DCXL4816842DM	\$7,540	\$7,876	\$8,298
	* 48 x 180 x 42	(2) Y / (2) T	DCXL4818042DM	\$7,884	\$8,239	\$8,684
	** 48 x 192 x 42	(2) Y / (3) T	DCXL4819242DM	\$8,940	\$9,314	\$9,782
	** 48 x 204 x 42	(2) Y / (3) T	DCXL4820442DM	\$9,349	\$9,742	\$10,233
	** 48 x 216 x 42	(2) Y / (4) T	DCXL4821642DM	\$9,394	\$9,805	\$10,319
	** 48 x 228 x 42	(2) Y / (4) T	DCXL4822842DM	\$10,060	\$10,490	\$11,028
	** 48 x 240 x 42	(2) Y / (4) T	DCXL4824042DM	\$10,473	\$10,922	\$11,484

WIDTH 54" | HEIGHT 42" Use 60" wide sizes/pricing below- specify model # accordingly: (54" x 96" x 42" = DCXL549642DM)

SIZE	BASE INFO #, Style	MODEL #	ABS 1 S	ABS 2 M	ABS 3 KV	
WIDTH 60" HEIGHT 42"						
	60 x 84 x 42	(2) Y	DCXL608442DM	\$4,147	\$4,372	\$4,772
	60 x 96 x 42	(2) Y	DCXL609642DM	\$4,429	\$4,672	\$5,105
	60 x 108 x 42	(2) Y	DCXL6010842DM	\$5,123	\$5,385	\$5,852
	* 60 x 120 x 42	(2) Y / (1) T	DCXL6012042DM	\$6,143	\$6,423	\$6,924
	* 60 x 144 x 42	(2) Y / (1) T	DCXL6014442DM	\$6,518	\$6,836	\$7,402
	* 60 x 156 x 42	(2) Y / (2) T	DCXL6015642DM	\$7,928	\$8,265	\$8,865
	* 60 x 168 x 42	(2) Y / (2) T	DCXL6016842DM	\$8,116	\$8,471	\$9,104
	* 60 x 180 x 42	(2) Y / (2) T	DCXL6018042DM	\$8,397	\$8,771	\$9,438
	** 60 x 192 x 42	(2) Y / (3) T	DCXL6019242DM	\$9,594	\$9,986	\$10,687
	** 60 x 204 x 42	(2) Y / (3) T	DCXL6020442DM	\$9,936	\$10,348	\$11,081
	** 60 x 216 x 42	(2) Y / (4) T	DCXL6021642DM	\$10,124	\$10,554	\$11,321
	** 60 x 228 x 42	(2) Y / (4) T	DCXL6022842DM	\$10,726	\$11,174	\$11,974
	** 60 x 240 x 42	(2) Y / (4) T	DCXL6024042DM	\$11,281	\$11,748	\$12,582

• To specify 36" high tables, use 42" high sizes/pricing above & adjust model # accordingly: (60" x 84" x 36" = DCXL608436DM)



OPTIONAL:
Decorative Foot Extension in Black.
Add \$95.00 List- Per Double Leg.
Consult factory for other colors.

Standard Features:

- Adjustable leveling glides included.
- Power/Data options available, see Power/Data Solutions page.
- Wire management, grommets, etc. available, consult factory.

(*) = 2-Piece Top. (**) = 3-Piece Top Spline & Joint Fasteners included with table.

NOTE: Woodgrain pattern alignment between multiple tops not guaranteed.

HPL TOPS | 44 standard HPL finishes

METAL BASES | 11 powder coat finishes

EDGES | matching & coordinating finishes in the following options:

ABS 1: PVC-free impact resistant flat edge (S)

ABS 2: Multi-Ply "Plywood Look" flat vinyl edge (M)

ABS 3: Knife (KV), 1/2" Flat edge- bevel painted in a companion color

- Refer to edge code, above in (), when pricing below -

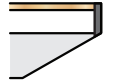

SIZE	BASE INFO #, Style	MODEL #	ABS 1 S	ABS 2 M	ABS 3 KV	
WIDTH 42" HEIGHT 29"						
	42 x 72 x 29	(2) Y	DCXL4272BE	\$2,656	\$2,834	\$3,056
	42 x 84 x 29	(2) Y	DCXL4284BE	\$2,905	\$3,114	\$3,375
	42 x 96 x 29	(2) Y	DCXL4296BE	\$3,143	\$3,358	\$3,627

• For additional table sizes at 42" wide, use 48" wide sizes/pricing below- specify model # accordingly: (42" x 144" x 29" = DCXL42144BE)

WIDTH 48" HEIGHT 29"						
	48 x 84 x 29	(2) Y	DCXL4884BE	\$3,316	\$3,521	\$3,779
	48 x 96 x 29	(2) Y	DCXL4896BE	\$3,489	\$3,714	\$3,994
	48 x 108 x 29	(2) Y	DCXL48108BE	\$4,137	\$4,380	\$4,685
	* 48 x 120 x 29	(2) Y / (1) T	DCXL48120BE	\$5,162	\$5,424	\$5,752
	* 48 x 144 x 29	(2) Y / (1) T	DCXL48144BE	\$5,586	\$5,885	\$6,260
	* 48 x 156 x 29	(2) Y / (2) T	DCXL48156BE	\$6,746	\$7,064	\$7,462
	* 48 x 168 x 29	(2) Y / (2) T	DCXL48168BE	\$6,793	\$7,129	\$7,550
	* 48 x 180 x 29	(2) Y / (2) T	DCXL48180BE	\$7,137	\$7,492	\$7,936
	** 48 x 192 x 29	(2) Y / (3) T	DCXL48192BE	\$8,006	\$8,380	\$8,848
	** 48 x 204 x 29	(2) Y / (3) T	DCXL48204BE	\$8,415	\$8,807	\$9,299
	** 48 x 216 x 29	(2) Y / (4) T	DCXL48216BE	\$8,460	\$8,870	\$9,384
	** 48 x 228 x 29	(2) Y / (4) T	DCXL48228BE	\$9,126	\$9,556	\$10,094
	** 48 x 240 x 29	(2) Y / (4) T	DCXL48240BE	\$9,539	\$9,988	\$10,549

WIDTH 54" | HEIGHT 29" Use 60" wide sizes/pricing below- specify model # accordingly: (54" x 96" x 42" = DCXL549642BE)

WIDTH 60" HEIGHT 29"						
	60 x 84 x 29	(2) Y	DCXL6084BE	\$3,774	\$3,998	\$4,398
	60 x 96 x 29	(2) Y	DCXL6096BE	\$4,055	\$4,298	\$4,732
	60 x 108 x 29	(2) Y	DCXL60108BE	\$4,750	\$5,011	\$5,478
	* 60 x 120 x 29	(2) Y / (1) T	DCXL60120BE	\$5,582	\$5,863	\$6,363
	* 60 x 144 x 29	(2) Y / (1) T	DCXL60144BE	\$5,957	\$6,275	\$6,842
	* 60 x 156 x 29	(2) Y / (2) T	DCXL60156BE	\$7,181	\$7,517	\$8,117
	* 60 x 168 x 29	(2) Y / (2) T	DCXL60168BE	\$7,368	\$7,723	\$8,357
	* 60 x 180 x 29	(2) Y / (2) T	DCXL60180BE	\$7,650	\$8,024	\$8,691
	** 60 x 192 x 29	(2) Y / (3) T	DCXL60192BE	\$8,659	\$9,052	\$9,752
	** 60 x 204 x 29	(2) Y / (3) T	DCXL60204BE	\$9,002	\$9,413	\$10,147
	** 60 x 216 x 29	(2) Y / (4) T	DCXL60216BE	\$9,189	\$9,619	\$10,386
	** 60 x 228 x 29	(2) Y / (4) T	DCXL60228BE	\$9,791	\$10,240	\$11,040
	** 60 x 240 x 29	(2) Y / (4) T	DCXL60240BE	\$10,347	\$10,814	\$11,647



OPTIONAL:
Decorative Foot Extension in Black.
Add \$95.00 List- Per Double Leg.
Consult factory for other colors.

Standard Features:

- Adjustable leveling glides included.
 - Power/Data options available, see Power/Data Solutions page.
 - Wire management, grommets, etc. available, consult factory.
 - (*) = 2-Piece Top. (**) = 3-Piece Top Spline & Joint Fasteners included with table.
- NOTE: Woodgrain pattern alignment between multiple tops not guaranteed.

HPL TOPS | 44 standard HPL finishes

METAL BASES | 11 powder coat finishes

EDGES | matching & coordinating finishes in the following options:

ABS 1: PVC-free impact resistant flat edge (S)

ABS 2: Multi-Ply "Plywood Look" flat vinyl edge (M)

ABS 3: Knife (KV), 1/2" Flat edge- bevel painted in a companion color

- Refer to edge code, above in (), when pricing below -

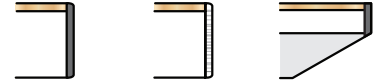

SIZE	BASE INFO #, Style	MODEL #	ABS 1 S	ABS 2 M	ABS 3 KV	
WIDTH 42" HEIGHT 42"						
	42 x 72 x 42	(2) Y	DCXL427242BE	\$3,030	\$3,207	\$3,430
	42 x 84 x 42	(2) Y	DCXL428442BE	\$3,279	\$3,488	\$3,749
	42 x 96 x 42	(2) Y	DCXL429642BE	\$3,517	\$3,732	\$4,001

• For additional tables at 42" wide, use 48" wide sizes/pricing below- specify model # accordingly: (42" x 144" x 42" = DCXL4214442BE)

SIZE	BASE INFO #, Style	MODEL #	ABS 1 S	ABS 2 M	ABS 3 KV	
WIDTH 48" HEIGHT 42"						
	48 x 84 x 42	(2) Y	DCXL488442BE	\$3,690	\$3,895	\$4,153
	48 x 96 x 42	(2) Y	DCXL489642BE	\$3,863	\$4,087	\$4,368
	48 x 108 x 42	(2) Y	DCXL4810842BE	\$4,511	\$4,754	\$5,058
	* 48 x 120 x 42	(2) Y / (1) T	DCXL4812042BE	\$5,723	\$5,985	\$6,312
	* 48 x 144 x 42	(2) Y / (1) T	DCXL4814442BE	\$6,147	\$6,446	\$6,820
	* 48 x 156 x 42	(2) Y / (2) T	DCXL4815642BE	\$7,494	\$7,811	\$8,209
	* 48 x 168 x 42	(2) Y / (2) T	DCXL4816842BE	\$7,540	\$7,876	\$8,298
	* 48 x 180 x 42	(2) Y / (2) T	DCXL4818042BE	\$7,884	\$8,239	\$8,684
	** 48 x 192 x 42	(2) Y / (3) T	DCXL4819242BE	\$8,940	\$9,314	\$9,782
	** 48 x 204 x 42	(2) Y / (3) T	DCXL4820442BE	\$9,349	\$9,742	\$10,233
	** 48 x 216 x 42	(2) Y / (4) T	DCXL4821642BE	\$9,394	\$9,805	\$10,319
	** 48 x 228 x 42	(2) Y / (4) T	DCXL4822842BE	\$10,060	\$10,490	\$11,028
	** 48 x 240 x 42	(2) Y / (4) T	DCXL4824042BE	\$10,473	\$10,922	\$11,484

WIDTH 54" | HEIGHT 42" Use 60" wide sizes/pricing below- specify model # accordingly: (54" x 96" x 42" = DCXL549642BE)

SIZE	BASE INFO #, Style	MODEL #	ABS 1 S	ABS 2 M	ABS 3 KV	
WIDTH 60" HEIGHT 42"						
	60 x 84 x 42	(2) Y	DCXL608442BE	\$4,147	\$4,372	\$4,772
	60 x 96 x 42	(2) Y	DCXL609642BE	\$4,429	\$4,672	\$5,105
	60 x 108 x 42	(2) Y	DCXL6010842BE	\$5,123	\$5,385	\$5,852
	* 60 x 120 x 42	(2) Y / (1) T	DCXL6012042BE	\$6,143	\$6,423	\$6,924
	* 60 x 144 x 42	(2) Y / (1) T	DCXL6014442BE	\$6,518	\$6,836	\$7,402
	* 60 x 156 x 42	(2) Y / (2) T	DCXL6015642BE	\$7,928	\$8,265	\$8,865
	* 60 x 168 x 42	(2) Y / (2) T	DCXL6016842BE	\$8,116	\$8,471	\$9,104
	* 60 x 180 x 42	(2) Y / (2) T	DCXL6018042BE	\$8,397	\$8,771	\$9,438
	** 60 x 192 x 42	(2) Y / (3) T	DCXL6019242BE	\$9,594	\$9,986	\$10,687
	** 60 x 204 x 42	(2) Y / (3) T	DCXL6020442BE	\$9,936	\$10,348	\$11,081
	** 60 x 216 x 42	(2) Y / (4) T	DCXL6021642BE	\$10,124	\$10,554	\$11,321
	** 60 x 228 x 42	(2) Y / (4) T	DCXL6022842BE	\$10,726	\$11,174	\$11,974
	** 60 x 240 x 42	(2) Y / (4) T	DCXL6024042BE	\$11,281	\$11,748	\$12,582

• To specify 36" high tables, use 42" high sizes/pricing above & adjust model # accordingly: (60" x 84" x 36" = DCXL608436SBE)



OPTIONAL:
Decorative Foot Extension in Black.
Add \$95.00 List- Per Double Leg.
Consult factory for other colors.

Standard Features:

- Adjustable leveling glides included.
- Power/Data options available, see Power/Data Solutions page.
- Wire management, grommets, etc. available, consult factory.

(*) = 2-Piece Top. (**) = 3-Piece Top Spline & Joint Fasteners included with table.

NOTE: Woodgrain pattern alignment between multiple tops not guaranteed.

HPL TOPS | 44 standard HPL finishes

METAL BASES | 11 powder coat finishes

EDGES | matching & coordinating finishes in the following options:

ABS 1: PVC-free impact resistant flat edge (S)

ABS 2: Multi-Ply "Plywood Look" flat vinyl edge (M)

ABS 3: Knife (KV), 1/2" Flat edge- bevel painted in a companion color

- Refer to edge code, above in (), when pricing below -



SIZE	BASE INFO #, Style	MODEL #	ABS 1 S	ABS 2 M	ABS 3 KV	
WIDTH 42" HEIGHT 29"						
	42 x 72 x 29	(2) Y	DCXL4284OV	\$2,656	\$2,834	\$3,056
	42 x 84 x 29	(2) Y	DCXL4284OV	\$2,905	\$3,114	\$3,375
	42 x 96 x 29	(2) Y	DCXL4296OV	\$3,143	\$3,358	\$3,627
• For additional table sizes at 42" wide, use 48" wide sizes/pricing below- specify model # accordingly: (42" x 144" x 29" = DCXL42144OV)						
WIDTH 48" HEIGHT 29"						
	48 x 84 x 29	(2) Y	DCXL4884OV	\$3,316	\$3,521	\$3,779
	48 x 96 x 29	(2) Y	DCXL4896OV	\$3,489	\$3,714	\$3,994
	48 x 108 x 29	(2) Y	DCXL48108OV	\$4,137	\$4,380	\$4,685
	* 48 x 120 x 29	(2) Y	DCXL48120OV	\$5,162	\$5,424	\$5,752
	* 48 x 144 x 29	(2) Y / (1) T	DCXL48144OV	\$5,586	\$5,885	\$6,260
WIDTH 54" HEIGHT 29" : Use 60" wide sizes/pricing below- specify model # accordingly: (54" x 96" x 29" = DCXL5496OV)						
WIDTH 60" HEIGHT 29"						
	60 x 84 x 29	(2) Y	DCXL6084OV	\$3,774	\$3,998	\$4,398
	60 x 96 x 29	(2) Y	DCXL6096OV	\$4,055	\$4,298	\$4,732
	60 x 108 x 29	(2) Y	DCXL60108OV	\$4,750	\$5,011	\$5,478
	* 60 x 120 x 29	(2) Y	DCXL60120OV	\$5,582	\$5,863	\$6,363
	* 60 x 144 x 29	(2) Y / (1) T	DCXL60144OV	\$5,957	\$6,275	\$6,842
WIDTH 42" HEIGHT 42"						
	42 x 72 x 42	(2) Y	DCXL427242OV	\$3,030	\$3,207	\$3,430
	42 x 84 x 42	(2) Y	DCXL428442OV	\$3,279	\$3,488	\$3,749
	42 x 96 x 42	(2) Y	DCXL429642OV	\$3,517	\$3,732	\$4,001
• For additional table sizes at 42" wide, use 48" wide sizes/pricing below- specify model # accordingly: (42" x 108" x 42" = DCXL4210842OV)						
WIDTH 48" HEIGHT 42"						
	48 x 84 x 42	(2) Y	DCXL488442OV	\$3,690	\$3,895	\$4,153
	48 x 96 x 42	(2) Y	DCXL489642OV	\$3,863	\$4,087	\$4,368
	48 x 108 x 42	(2) Y	DCXL4810842OV	\$4,511	\$4,754	\$5,058
	* 48 x 120 x 42	(2) Y	DCXL4812042OV	\$5,723	\$5,985	\$6,312
	* 48 x 144 x 42	(2) Y / (1) T	DCXL4814442OV	\$6,147	\$6,446	\$6,820
WIDTH 54" HEIGHT 42" : Use 60" wide sizes/pricing below- specify model # accordingly: (54" x 96" x 42" = DCXL549642OV)						
WIDTH 60" HEIGHT 42"						
	60 x 84 x 42	(2) Y	DCXL608442OV	\$4,147	\$4,372	\$4,772
	60 x 96 x 42	(2) Y	DCXL609642OV	\$4,429	\$4,672	\$5,105
	60 x 108 x 42	(2) Y	DCXL6010842OV	\$5,123	\$5,385	\$5,852
	* 60 x 120 x 42	(2) Y	DCXL6012042OV	\$6,143	\$6,423	\$6,924
	* 60 x 144 x 42	(2) Y / (1) T	DCXL6014442OV	\$6,518	\$6,836	\$7,402

• To specify 36" high tables, use 42" high sizes/pricing above & adjust model # accordingly: (60" x 84" x 36" = DCXL608436OV)



OPTIONAL:
Decorative Foot Extension in Black.
Add \$95.00 List- Per Double Leg.
Consult factory for other colors.

Standard Features:

- Adjustable leveling glides included.
- Power/Data options available, see Power/Data Solutions page.
- Wire management, grommets, etc. available, consult factory.

(*) = 2-Piece Top. (**) = 3-Piece Top Spline & Joint Fasteners included with table.

NOTE: Woodgrain pattern alignment between multiple tops not guaranteed.

HPL TOPS | 44 standard HPL finishes

METAL BASES | 11 powder coat finishes

EDGES | matching & coordinating finishes in the following options:

ABS 1: PVC-free impact resistant flat edge (S)

ABS 2: Multi-Ply "Plywood Look" flat vinyl edge (M)

ABS 3: Knife (KV), 1/2" Flat edge- bevel painted in a companion color

- Refer to edge code, above in (), when pricing below -

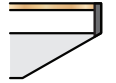

SIZE	BASE INFO #, Style	MODEL #	ABS 1 S	ABS 2 M	ABS 3 KV	
WIDTH 42" HEIGHT 29"						
	42 x 72 x 29	(2) Y	DCXL4272RT	\$2,656	\$2,834	\$3,056
	42 x 84 x 29	(2) Y	DCXL4284RT	\$2,905	\$3,114	\$3,375
	42 x 96 x 29	(2) Y	DCXL4296RT	\$3,143	\$3,358	\$3,627

• For additional table sizes at 42" wide, use 48" wide sizes/pricing below- specify model # accordingly: (42" x 144" x 29" = DCXL42144RT)

WIDTH 48" HEIGHT 29"						
	48 x 84 x 29	(2) Y	DCXL4884RT	\$3,316	\$3,521	\$3,779
	48 x 96 x 29	(2) Y	DCXL4896RT	\$3,489	\$3,714	\$3,994
	48 x 108 x 29	(2) Y	DCXL48108RT	\$4,137	\$4,380	\$4,685
	* 48 x 120 x 29	(2) Y / (1) T	DCXL48120RT	\$5,162	\$5,424	\$5,752
	* 48 x 144 x 29	(2) Y / (1) T	DCXL48144RT	\$5,586	\$5,885	\$6,260
	* 48 x 156 x 29	(2) Y / (2) T	DCXL48156RT	\$6,746	\$7,064	\$7,462
	* 48 x 168 x 29	(2) Y / (2) T	DCXL48168RT	\$6,793	\$7,129	\$7,550
	* 48 x 180 x 29	(2) Y / (2) T	DCXL48180RT	\$7,137	\$7,492	\$7,936
	** 48 x 192 x 29	(2) Y / (3) T	DCXL48192RT	\$8,006	\$8,380	\$8,848
	** 48 x 204 x 29	(2) Y / (3) T	DCXL48204RT	\$8,415	\$8,807	\$9,299
	** 48 x 216 x 29	(2) Y / (4) T	DCXL48216RT	\$8,460	\$8,870	\$9,384
	** 48 x 228 x 29	(2) Y / (4) T	DCXL48228RT	\$9,126	\$9,556	\$10,094
	** 48 x 240 x 29	(2) Y / (4) T	DCXL48240RT	\$9,539	\$9,988	\$10,549

WIDTH 54" | HEIGHT 29" Use 60" wide sizes/pricing below- specify model # accordingly: (54" x 96" x 29" = DCXL5496RT)

WIDTH 60" HEIGHT 29"						
	60 x 84 x 29	(2) Y	DCXL6084RT	\$3,774	\$3,998	\$4,398
	60 x 96 x 29	(2) Y	DCXL6096RT	\$4,055	\$4,298	\$4,732
	60 x 108 x 29	(2) Y	DCXL60108RT	\$4,750	\$5,011	\$5,478
	* 60 x 120 x 29	(2) Y / (1) T	DCXL60120RT	\$5,582	\$5,863	\$6,363
	* 60 x 144 x 29	(2) Y / (1) T	DCXL60144RT	\$5,957	\$6,275	\$6,842
	* 60 x 156 x 29	(2) Y / (2) T	DCXL60156RT	\$7,181	\$7,517	\$8,117
	* 60 x 168 x 29	(2) Y / (2) T	DCXL60168RT	\$7,368	\$7,723	\$8,357
	* 60 x 180 x 29	(2) Y / (2) T	DCXL60180RT	\$7,650	\$8,024	\$8,691
	** 60 x 192 x 29	(2) Y / (3) T	DCXL60192RT	\$8,659	\$9,052	\$9,752
	** 60 x 204 x 29	(2) Y / (3) T	DCXL60204RT	\$9,002	\$9,413	\$10,147
	** 60 x 216 x 29	(2) Y / (4) T	DCXL60216RT	\$9,189	\$9,619	\$10,386
	** 60 x 228 x 29	(2) Y / (4) T	DCXL60228RT	\$9,791	\$10,240	\$11,040
	** 60 x 240 x 29	(2) Y / (4) T	DCXL60240RT	\$10,347	\$10,814	\$11,647



OPTIONAL:
Decorative Foot Extension in Black.
Add \$95.00 List- Per Double Leg.
Consult factory for other colors.

Standard Features:

- Adjustable leveling glides included.
- Power/Data options available, see Power/Data Solutions page.
- Wire management, grommets, etc. available, consult factory.

(*) = 2-Piece Top. (**) = 3-Piece Top Spline & Joint Fasteners included with table.

NOTE: Woodgrain pattern alignment between multiple tops not guaranteed.

HPL TOPS | 44 standard HPL finishes

METAL BASES | 11 powder coat finishes

EDGES | matching & coordinating finishes in the following options:

ABS 1: PVC-free impact resistant flat edge (S)

ABS 2: Multi-Ply "Plywood Look" flat vinyl edge (M)

ABS 3: Knife (KV), 1/2" Flat edge- bevel painted in a companion color

- Refer to edge code, above in (), when pricing below -

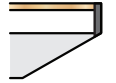

SIZE	BASE INFO #, Style	MODEL #	ABS 1 S	ABS 2 M	ABS 3 KV	
WIDTH 42" HEIGHT 42"						
	42 x 72 x 42	(2) Y	DCXL427242RT	\$3,030	\$3,207	\$3,430
	42 x 84 x 42	(2) Y	DCXL428442RT	\$3,279	\$3,488	\$3,749
	42 x 96 x 42	(2) Y	DCXL429642RT	\$3,517	\$3,732	\$4,001

• For additional tables at 42" wide, use 48" wide sizes/pricing below- specify model # accordingly: (42" x 144" x 42" = DCXL42144RT)

SIZE	BASE INFO #, Style	MODEL #	ABS 1 S	ABS 2 M	ABS 3 KV	
WIDTH 48" HEIGHT 42"						
	48 x 84 x 42	(2) Y	DCXL488442RT	\$3,690	\$3,895	\$4,153
	48 x 96 x 42	(2) Y	DCXL489642RT	\$3,863	\$4,087	\$4,368
	48 x 108 x 42	(2) Y	DCXL4810842RT	\$4,511	\$4,754	\$5,058
	* 48 x 120 x 42	(2) Y / (1) T	DCXL4812042RT	\$5,723	\$5,985	\$6,312
	* 48 x 144 x 42	(2) Y / (1) T	DCXL4814442RT	\$6,147	\$6,446	\$6,820
	* 48 x 156 x 42	(2) Y / (2) T	DCXL4815642RT	\$7,494	\$7,811	\$8,209
	* 48 x 168 x 42	(2) Y / (2) T	DCXL4816842RT	\$7,540	\$7,876	\$8,298
	* 48 x 180 x 42	(2) Y / (2) T	DCXL4818042RT	\$7,884	\$8,239	\$8,684
	** 48 x 192 x 42	(2) Y / (3) T	DCXL4819242RT	\$8,940	\$9,314	\$9,782
	** 48 x 204 x 42	(2) Y / (3) T	DCXL4820442RT	\$9,349	\$9,742	\$10,233
	** 48 x 216 x 42	(2) Y / (4) T	DCXL4821642RT	\$9,394	\$9,805	\$10,319
	** 48 x 228 x 42	(2) Y / (4) T	DCXL4822842RT	\$10,060	\$10,490	\$11,028
	** 48 x 240 x 42	(2) Y / (4) T	DCXL4824042RT	\$10,473	\$10,922	\$11,484

WIDTH 54" | HEIGHT 42" Use 60" wide sizes/pricing below- specify model # accordingly: (54" x 96" x 42" = DCXL549642RT)

SIZE	BASE INFO #, Style	MODEL #	ABS 1 S	ABS 2 M	ABS 3 KV	
WIDTH 60" HEIGHT 42"						
	60 x 84 x 42	(2) Y	DCXL608442RT	\$4,147	\$4,372	\$4,772
	60 x 96 x 42	(2) Y	DCXL609642RT	\$4,429	\$4,672	\$5,105
	60 x 108 x 42	(2) Y	DCXL6010842RT	\$5,123	\$5,385	\$5,852
	* 60 x 120 x 42	(2) Y / (1) T	DCXL6012042RT	\$6,143	\$6,423	\$6,924
	* 60 x 144 x 42	(2) Y / (1) T	DCXL6014442RT	\$6,518	\$6,836	\$7,402
	* 60 x 156 x 42	(2) Y / (2) T	DCXL6015642RT	\$7,928	\$8,265	\$8,865
	* 60 x 168 x 42	(2) Y / (2) T	DCXL6016842RT	\$8,116	\$8,471	\$9,104
	* 60 x 180 x 42	(2) Y / (2) T	DCXL6018042RT	\$8,397	\$8,771	\$9,438
	** 60 x 192 x 42	(2) Y / (3) T	DCXL6019242RT	\$9,594	\$9,986	\$10,687
	** 60 x 204 x 42	(2) Y / (3) T	DCXL6020442RT	\$9,936	\$10,348	\$11,081
	** 60 x 216 x 42	(2) Y / (4) T	DCXL6021642RT	\$10,124	\$10,554	\$11,321
	** 60 x 228 x 42	(2) Y / (4) T	DCXL6022842RT	\$10,726	\$11,174	\$11,974
	** 60 x 240 x 42	(2) Y / (4) T	DCXL6024042RT	\$11,281	\$11,748	\$12,582

• To specify 36" high tables, use 42" high sizes/pricing above & adjust model # accordingly: (60" x 84" x 36" = DCXL608436RT)



OPTIONAL:
Decorative Foot Extension in Black.
Add \$95.00 List- Per Double Leg.
Consult factory for other colors.

Standard Features:

- Adjustable leveling glides included.
- Power/Data options available, see Power/Data Solutions page.
- Wire management, grommets, etc. available, consult factory.

(*) = 2-Piece Top. (**) = 3-Piece Top Spline & Joint Fasteners included with table.

NOTE: Woodgrain pattern alignment between multiple tops not guaranteed.

HPL TOPS | 44 standard HPL finishes

METAL BASES | 11 powder coat finishes

EDGES | matching & coordinating finishes in the following options:

ABS 1: PVC-free impact resistant flat edge (S)

ABS 2: Multi-Ply "Plywood Look" flat vinyl edge (M)

ABS 3: Knife (KV), 1/2" Flat edge- bevel painted in a companion color

- Refer to edge code, above in (), when pricing below -

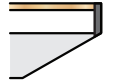

SIZE	BASE INFO #, Style	MODEL #	ABS 1 S	ABS 2 M	ABS 3 KV	
WIDTH 42" HEIGHT 29"						
	42 x 72 x 29	(2) Y	DCXL4272BR	\$2,656	\$2,834	\$3,056
	42 x 84 x 29	(2) Y	DCXL4284BR	\$2,905	\$3,114	\$3,375
	42 x 96 x 29	(2) Y	DCXL4296BR	\$3,143	\$3,358	\$3,627

• For additional table sizes at 42" wide, use 48" wide sizes/pricing below- specify model # accordingly: (42" x 144" x 29" = DCXL42144BR)

WIDTH 48" HEIGHT 29"						
	48 x 84 x 29	(2) Y	DCXL4884BR	\$3,316	\$3,521	\$3,779
	48 x 96 x 29	(2) Y	DCXL4896BR	\$3,489	\$3,714	\$3,994
	48 x 108 x 29	(2) Y	DCXL48108BR	\$4,137	\$4,380	\$4,685
	* 48 x 120 x 29	(2) Y / (1) T	DCXL48120BR	\$5,162	\$5,424	\$5,752
	* 48 x 144 x 29	(2) Y / (1) T	DCXL48144BR	\$5,586	\$5,885	\$6,260
	* 48 x 156 x 29	(2) Y / (2) T	DCXL48156BR	\$6,746	\$7,064	\$7,462
	* 48 x 168 x 29	(2) Y / (2) T	DCXL48168BR	\$6,793	\$7,129	\$7,550
	* 48 x 180 x 29	(2) Y / (2) T	DCXL48180BR	\$7,137	\$7,492	\$7,936
	** 48 x 192 x 29	(2) Y / (3) T	DCXL48192BR	\$8,006	\$8,380	\$8,848
	** 48 x 204 x 29	(2) Y / (3) T	DCXL48204BR	\$8,415	\$8,807	\$9,299
	** 48 x 216 x 29	(2) Y / (4) T	DCXL48216BR	\$8,460	\$8,870	\$9,384
	** 48 x 228 x 29	(2) Y / (4) T	DCXL48228BR	\$9,126	\$9,556	\$10,094
	** 48 x 240 x 29	(2) Y / (4) T	DCXL48240BR	\$9,539	\$9,988	\$10,549

WIDTH 54" | HEIGHT 29" Use 60" wide sizes/pricing below- specify model # accordingly: (54" x 96" x 29" = DCXL5496BR)

WIDTH 60" HEIGHT 29"						
	60 x 84 x 29	(2) Y	DCXL6084BR	\$3,774	\$3,998	\$4,398
	60 x 96 x 29	(2) Y	DCXL6096BR	\$4,055	\$4,298	\$4,732
	60 x 108 x 29	(2) Y	DCXL60108BR	\$4,750	\$5,011	\$5,478
	* 60 x 120 x 29	(2) Y / (1) T	DCXL60120BR	\$5,582	\$5,863	\$6,363
	* 60 x 144 x 29	(2) Y / (1) T	DCXL60144BR	\$5,957	\$6,275	\$6,842
	* 60 x 156 x 29	(2) Y / (2) T	DCXL60156BR	\$7,181	\$7,517	\$8,117
	* 60 x 168 x 29	(2) Y / (2) T	DCXL60168BR	\$7,368	\$7,723	\$8,357
	* 60 x 180 x 29	(2) Y / (2) T	DCXL60180BR	\$7,650	\$8,024	\$8,691
	** 60 x 192 x 29	(2) Y / (3) T	DCXL60192BR	\$8,659	\$9,052	\$9,752
	** 60 x 204 x 29	(2) Y / (3) T	DCXL60204BR	\$9,002	\$9,413	\$10,147
	** 60 x 216 x 29	(2) Y / (4) T	DCXL60216BR	\$9,189	\$9,619	\$10,386
	** 60 x 228 x 29	(2) Y / (4) T	DCXL60228BR	\$9,791	\$10,240	\$11,040
	** 60 x 240 x 29	(2) Y / (4) T	DCXL60240BR	\$10,347	\$10,814	\$11,647



OPTIONAL:
Decorative Foot Extension in Black.
Add \$95.00 List- Per Double Leg.
Consult factory for other colors.

Standard Features:

- Adjustable leveling glides included.
 - Power/Data options available, see Power/Data Solutions page.
 - Wire management, grommets, etc. available, consult factory.
- (*) = 2-Piece Top. (**) = 3-Piece Top Spline & Joint Fasteners included with table.

NOTE: Woodgrain pattern alignment between multiple tops not guaranteed.

HPL TOPS | 44 standard HPL finishes

METAL BASES | 11 powder coat finishes

EDGES | matching & coordinating finishes in the following options:

ABS 1: PVC-free impact resistant flat edge (S)

ABS 2: Multi-Ply "Plywood Look" flat vinyl edge (M)

ABS 3: Knife (KV), 1/2" Flat edge- bevel painted in a companion color

- Refer to edge code, above in (), when pricing below -

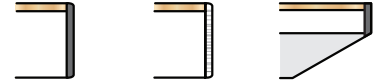

SIZE	BASE INFO #, Style	MODEL #	ABS 1 S	ABS 2 M	ABS 3 KV	
WIDTH 42" HEIGHT 42"						
	42 x 72 x 42	(2) Y	DCXL427242BR	\$3,030	\$3,207	\$3,430
	42 x 84 x 42	(2) Y	DCXL428442BR	\$3,279	\$3,488	\$3,749
	42 x 96 x 42	(2) Y	DCXL429642BR	\$3,517	\$3,732	\$4,001

• For additional tables at 42" wide, use 48" wide sizes/pricing below- specify model # accordingly: (42" x 144" x 42" = DCXL42144BR)

SIZE	BASE INFO #, Style	MODEL #	ABS 1 S	ABS 2 M	ABS 3 KV	
WIDTH 48" HEIGHT 42"						
	48 x 84 x 42	(2) Y	DCXL488442BR	\$3,690	\$3,895	\$4,153
	48 x 96 x 42	(2) Y	DCXL489642BR	\$3,863	\$4,087	\$4,368
	48 x 108 x 42	(2) Y	DCXL4810842BR	\$4,511	\$4,754	\$5,058
	* 48 x 120 x 42	(2) Y / (1) T	DCXL4812042BR	\$5,723	\$5,985	\$6,312
	* 48 x 144 x 42	(2) Y / (1) T	DCXL4814442BR	\$6,147	\$6,446	\$6,820
	* 48 x 156 x 42	(2) Y / (2) T	DCXL4815642BR	\$7,494	\$7,811	\$8,209
	* 48 x 168 x 42	(2) Y / (2) T	DCXL4816842BR	\$7,540	\$7,876	\$8,298
	* 48 x 180 x 42	(2) Y / (2) T	DCXL4818042BR	\$7,884	\$8,239	\$8,684
	** 48 x 192 x 42	(2) Y / (3) T	DCXL4819242BR	\$8,940	\$9,314	\$9,782
	** 48 x 204 x 42	(2) Y / (3) T	DCXL4820442BR	\$9,349	\$9,742	\$10,233
	** 48 x 216 x 42	(2) Y / (4) T	DCXL4821642BR	\$9,394	\$9,805	\$10,319
	** 48 x 228 x 42	(2) Y / (4) T	DCXL4822842BR	\$10,060	\$10,490	\$11,028
	** 48 x 240 x 42	(2) Y / (4) T	DCXL4824042BR	\$10,473	\$10,922	\$11,484

WIDTH 54" | HEIGHT 42" Use 60" wide sizes/pricing below- specify model # accordingly: (54" x 96" x 42" = DCXL549642BR)

SIZE	BASE INFO #, Style	MODEL #	ABS 1 S	ABS 2 M	ABS 3 KV	
WIDTH 60" HEIGHT 42"						
	60 x 84 x 42	(2) Y	DCXL608442BR	\$4,147	\$4,372	\$4,772
	60 x 96 x 42	(2) Y	DCXL609642BR	\$4,429	\$4,672	\$5,105
	60 x 108 x 42	(2) Y	DCXL6010842BR	\$5,123	\$5,385	\$5,852
	* 60 x 120 x 42	(2) Y / (1) T	DCXL6012042BR	\$6,143	\$6,423	\$6,924
	* 60 x 144 x 42	(2) Y / (1) T	DCXL6014442BR	\$6,518	\$6,836	\$7,402
	* 60 x 156 x 42	(2) Y / (2) T	DCXL6015642BR	\$7,928	\$8,265	\$8,865
	* 60 x 168 x 42	(2) Y / (2) T	DCXL6016842BR	\$8,116	\$8,471	\$9,104
	* 60 x 180 x 42	(2) Y / (2) T	DCXL6018042BR	\$8,397	\$8,771	\$9,438
	** 60 x 192 x 42	(2) Y / (3) T	DCXL6019242BR	\$9,594	\$9,986	\$10,687
	** 60 x 204 x 42	(2) Y / (3) T	DCXL6020442BR	\$9,936	\$10,348	\$11,081
	** 60 x 216 x 42	(2) Y / (4) T	DCXL6021642BR	\$10,124	\$10,554	\$11,321
	** 60 x 228 x 42	(2) Y / (4) T	DCXL6022842BR	\$10,726	\$11,174	\$11,974
	** 60 x 240 x 42	(2) Y / (4) T	DCXL6024042BR	\$11,281	\$11,748	\$12,582

• To specify 36" high tables, use 42" high sizes/pricing above & adjust model # accordingly: (60" x 84" x 36" = DCXL608436BR)



OPTIONAL:
Decorative Foot Extension in Black.
Add \$95.00 List- Per Double Leg.
Consult factory for other colors.

Standard Features:

- Adjustable leveling glides included.
 - Power/Data options available, see Power/Data Solutions page.
 - Wire management, grommets, etc. available, consult factory.
- (*) = 2-Piece Top. (**) = 3-Piece Top Spline & Joint Fasteners included with table.
NOTE: Woodgrain pattern alignment between multiple tops not guaranteed.

HPL TOPS | 44 standard HPL finishes

METAL BASES | 11 powder coat finishes

EDGES | matching & coordinating finishes in the following options:

ABS 1: PVC-free impact resistant flat edge (S)

ABS 2: Multi-Ply "Plywood Look" flat vinyl edge (M)

ABS 3: Knife (KV), 1/2" Flat edge- bevel painted in a companion color

- Refer to edge code, above in (), when pricing below -

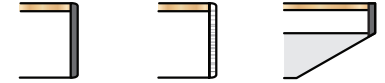

SIZE	BASE INFO #, Style	MODEL #	ABS 1 S	ABS 2 M	ABS 3 KV	
WIDTH 42" HEIGHT 29"						
	42 x 72 x 29	(2) Y	DCXL4272SW	\$2,656	\$2,834	\$3,056
	42 x 84 x 29	(2) Y	DCXL4284SW	\$2,905	\$3,114	\$3,375
	42 x 96 x 29	(2) Y	DCXL4296SW	\$3,143	\$3,358	\$3,627

• For additional table sizes at 42" wide, use 48" wide sizes/pricing below- specify model # accordingly: (42" x 144" x 29" = DCXL42144SW)

WIDTH 48" HEIGHT 29"						
	48 x 84 x 29	(2) Y	DCXL4884SW	\$3,316	\$3,521	\$3,779
	48 x 96 x 29	(2) Y	DCXL4896SW	\$3,489	\$3,714	\$3,994
	48 x 108 x 29	(2) Y	DCXL48108SW	\$4,137	\$4,380	\$4,685
	* 48 x 120 x 29	(2) Y / (1) T	DCXL48120SW	\$5,162	\$5,424	\$5,752
	* 48 x 144 x 29	(2) Y / (1) T	DCXL48144SW	\$5,586	\$5,885	\$6,260
	* 48 x 156 x 29	(2) Y / (2) T	DCXL48156SW	\$6,746	\$7,064	\$7,462
	* 48 x 168 x 29	(2) Y / (2) T	DCXL48168SW	\$6,793	\$7,129	\$7,550
	* 48 x 180 x 29	(2) Y / (2) T	DCXL48180SW	\$7,137	\$7,492	\$7,936
	** 48 x 192 x 29	(2) Y / (3) T	DCXL48192SW	\$8,006	\$8,380	\$8,848
	** 48 x 204 x 29	(2) Y / (3) T	DCXL48204SW	\$8,415	\$8,807	\$9,299
	** 48 x 216 x 29	(2) Y / (4) T	DCXL48216SW	\$8,460	\$8,870	\$9,384
	** 48 x 228 x 29	(2) Y / (4) T	DCXL48228SW	\$9,126	\$9,556	\$10,094
	** 48 x 240 x 29	(2) Y / (4) T	DCXL48240SW	\$9,539	\$9,988	\$10,549

WIDTH 54" | HEIGHT 29" Use 60" wide sizes/pricing below- specify model # accordingly: (54" x 96" x 29" = DCXL5496SW)

WIDTH 60" HEIGHT 29"						
	60 x 84 x 29	(2) Y	DCXL6084SW	\$3,774	\$3,998	\$4,398
	60 x 96 x 29	(2) Y	DCXL6096SW	\$4,055	\$4,298	\$4,732
	60 x 108 x 29	(2) Y	DCXL60108SW	\$4,750	\$5,011	\$5,478
	* 60 x 120 x 29	(2) Y / (1) T	DCXL60120SW	\$5,582	\$5,863	\$6,363
	* 60 x 144 x 29	(2) Y / (1) T	DCXL60144SW	\$5,957	\$6,275	\$6,842
	* 60 x 156 x 29	(2) Y / (2) T	DCXL60156SW	\$7,181	\$7,517	\$8,117
	* 60 x 168 x 29	(2) Y / (2) T	DCXL60168SW	\$7,368	\$7,723	\$8,357
	* 60 x 180 x 29	(2) Y / (2) T	DCXL60180SW	\$7,650	\$8,024	\$8,691
	** 60 x 192 x 29	(2) Y / (3) T	DCXL60192SW	\$8,659	\$9,052	\$9,752
	** 60 x 204 x 29	(2) Y / (3) T	DCXL60204SW	\$9,002	\$9,413	\$10,147
	** 60 x 216 x 29	(2) Y / (4) T	DCXL60216SW	\$9,189	\$9,619	\$10,386
	** 60 x 228 x 29	(2) Y / (4) T	DCXL60228SW	\$9,791	\$10,240	\$11,040
	** 60 x 240 x 29	(2) Y / (4) T	DCXL60240SW	\$10,347	\$10,814	\$11,647



OPTIONAL:
Decorative Foot Extension in Black.
Add \$95.00 List- Per Double Leg.
Consult factory for other colors.

Standard Features:

- Adjustable leveling glides included.
- Power/Data options available, see Power/Data Solutions page.
- Wire management, grommets, etc. available, consult factory.
- (*) = 2-Piece Top. (**) = 3-Piece Top Spline & Joint Fasteners included with table.

NOTE: Woodgrain pattern alignment between multiple tops not guaranteed.

HPL TOPS | 44 standard HPL finishes

METAL BASES | 11 powder coat finishes

EDGES | matching & coordinating finishes in the following options:

ABS 1: PVC-free impact resistant flat edge (S)

ABS 2: Multi-Ply "Plywood Look" flat vinyl edge (M)

ABS 3: Knife (KV), 1/2" Flat edge- bevel painted in a companion color

- Refer to edge code, above in (), when pricing below -

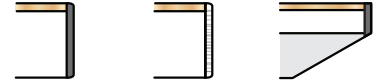

SIZE	BASE INFO #, Style	MODEL #	ABS 1 S	ABS 2 M	ABS 3 KV	
WIDTH 42" HEIGHT 42"						
	42 x 72 x 42	(2) Y	DCXL427242SW	\$3,030	\$3,207	\$3,430
	42 x 84 x 42	(2) Y	DCXL428442SW	\$3,279	\$3,488	\$3,749
	42 x 96 x 42	(2) Y	DCXL429642SW	\$3,517	\$3,732	\$4,001

• For additional tables at 42" wide, use 48" wide sizes/pricing below- specify model # accordingly: (42" x 144" x 42" = DCXL42144SW)

SIZE	BASE INFO #, Style	MODEL #	ABS 1 S	ABS 2 M	ABS 3 KV	
WIDTH 48" HEIGHT 42"						
	48 x 84 x 42	(2) Y	DCXL488442SW	\$3,690	\$3,895	\$4,153
	48 x 96 x 42	(2) Y	DCXL489642SW	\$3,863	\$4,087	\$4,368
	48 x 108 x 42	(2) Y	DCXL4810842SW	\$4,511	\$4,754	\$5,058
	* 48 x 120 x 42	(2) Y / (1) T	DCXL4812042SW	\$5,723	\$5,985	\$6,312
	* 48 x 144 x 42	(2) Y / (1) T	DCXL4814442SW	\$6,147	\$6,446	\$6,820
	* 48 x 156 x 42	(2) Y / (2) T	DCXL4815642SW	\$7,494	\$7,811	\$8,209
	* 48 x 168 x 42	(2) Y / (2) T	DCXL4816842SW	\$7,540	\$7,876	\$8,298
	* 48 x 180 x 42	(2) Y / (2) T	DCXL4818042SW	\$7,884	\$8,239	\$8,684
	** 48 x 192 x 42	(2) Y / (3) T	DCXL4819242SW	\$8,940	\$9,314	\$9,782
	** 48 x 204 x 42	(2) Y / (3) T	DCXL4820442SW	\$9,349	\$9,742	\$10,233
	** 48 x 216 x 42	(2) Y / (4) T	DCXL4821642SW	\$9,394	\$9,805	\$10,319
	** 48 x 228 x 42	(2) Y / (4) T	DCXL4822842SW	\$10,060	\$10,490	\$11,028
	** 48 x 240 x 42	(2) Y / (4) T	DCXL4824042SW	\$10,473	\$10,922	\$11,484

WIDTH 54" | HEIGHT 42" Use 60" wide sizes/pricing below- specify model # accordingly: (54" x 96" x 42" = DCXL549642SW)

SIZE	BASE INFO #, Style	MODEL #	ABS 1 S	ABS 2 M	ABS 3 KV	
WIDTH 60" HEIGHT 42"						
	60 x 84 x 42	(2) Y	DCXL608442SW	\$4,147	\$4,372	\$4,772
	60 x 96 x 42	(2) Y	DCXL609642SW	\$4,429	\$4,672	\$5,105
	60 x 108 x 42	(2) Y	DCXL6010842SW	\$5,123	\$5,385	\$5,852
	* 60 x 120 x 42	(2) Y / (1) T	DCXL6012042SW	\$6,143	\$6,423	\$6,924
	* 60 x 144 x 42	(2) Y / (1) T	DCXL6014442SW	\$6,518	\$6,836	\$7,402
	* 60 x 156 x 42	(2) Y / (2) T	DCXL6015642SW	\$7,928	\$8,265	\$8,865
	* 60 x 168 x 42	(2) Y / (2) T	DCXL6016842SW	\$8,116	\$8,471	\$9,104
	* 60 x 180 x 42	(2) Y / (2) T	DCXL6018042SW	\$8,397	\$8,771	\$9,438
	** 60 x 192 x 42	(2) Y / (3) T	DCXL6019242SW	\$9,594	\$9,986	\$10,687
	** 60 x 204 x 42	(2) Y / (3) T	DCXL6020442SW	\$9,936	\$10,348	\$11,081
	** 60 x 216 x 42	(2) Y / (4) T	DCXL6021642SW	\$10,124	\$10,554	\$11,321
	** 60 x 228 x 42	(2) Y / (4) T	DCXL6022842SW	\$10,726	\$11,174	\$11,974
	** 60 x 240 x 42	(2) Y / (4) T	DCXL6024042SW	\$11,281	\$11,748	\$12,582

• To specify 36" high tables, use 42" high sizes/pricing above & adjust model # accordingly: (60" x 84" x 36" = DCXL608436SW)



OPTIONAL:
Decorative Foot Extension in Black.
Add \$95.00 List- Per Double Leg.
Consult factory for other colors.

Standard Features:

- Adjustable leveling glides included.
- Power/Data options available, see Power/Data Solutions page.
- Wire management, grommets, etc. available, consult factory.

(*) = 2-Piece Top. (**) = 3-Piece Top Spline & Joint Fasteners included with table.

NOTE: Woodgrain pattern alignment between multiple tops not guaranteed.

HPL TOPS | 44 standard HPL finishes

METAL BASES | 11 powder coat finishes

EDGES | matching & coordinating finishes in the following options:

ABS 1: PVC-free impact resistant flat edge (S)

ABS 2: Multi-Ply "Plywood Look" flat vinyl edge (M)

ABS 3: Knife (KV), 1/2" Flat edge- bevel painted in a companion color

- Refer to edge code, above in (), when pricing below -

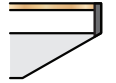

SIZE	BASE INFO #, Style	MODEL #	ABS 1 S	ABS 2 M	ABS 3 KV
------	-----------------------	---------	------------	------------	-------------

WIDTH 42" | HEIGHT 29" Use 48" wide sizes/pricing below- specify model # accordingly: (42" x 96" x 29" = DCXL4296BU)

WIDTH 48" | HEIGHT 29"

	48 x 72 x 29	(2) Y	DCXL4872BU	\$3,157	\$3,344	\$3,578
	48 x 78 x 29	(2) Y	DCXL4878BU	\$3,316	\$3,512	\$3,758
	48 x 84 x 29	(2) Y	DCXL4884BU	\$3,345	\$3,550	\$3,808
	48 x 96 x 29	(2) Y	DCXL4896BU	\$3,489	\$3,714	\$3,994
	48 x 108 x 29	(2) Y	DCXL48108BU	\$4,137	\$4,380	\$4,685
	* 48 x 120 x 29	(2) Y / (1) T	DCXL48120BU	\$5,162	\$5,424	\$5,752
	* 48 x 144 x 29	(2) Y / (1) T	DCXL48144BU	\$5,586	\$5,885	\$6,260

WIDTH 54" | HEIGHT 29" Use 60" wide sizes/pricing below- specify model # accordingly: (54" x 96" x 29" = DCXL5496BU)

WIDTH 60" | HEIGHT 29"

	60 x 72 x 29	(2) Y	DCXL6072BU	\$3,628	\$3,834	\$4,201
	60 x 78 x 29	(2) Y	DCXL6078BU	\$3,775	\$3,990	\$4,373
	60 x 84 x 29	(2) Y	DCXL6084BU	\$3,802	\$4,027	\$4,427
	60 x 96 x 29	(2) Y	DCXL6096BU	\$4,055	\$4,298	\$4,732
	60 x 108 x 29	(2) Y	DCXL60108BU	\$4,750	\$5,011	\$5,478
	* 60 x 120 x 29	(2) Y / (1) T	DCXL60120BU	\$5,582	\$5,863	\$6,363
	* 60 x 144 x 29	(2) Y / (1) T	DCXL60144BU	\$5,957	\$6,275	\$6,842

WIDTH 42" | HEIGHT 42" Use 48" wide sizes/pricing below- specify model # accordingly: (42" x 96" x 42" = DCXL429642BU)

WIDTH 48" | HEIGHT 42"

	48 x 72 x 42	(2) Y	DCXL487242BU	\$3,531	\$3,717	\$3,951
	48 x 78 x 42	(2) Y	DCXL487842BU	\$3,690	\$3,886	\$4,132
	48 x 84 x 42	(2) Y	DCXL488442BU	\$3,718	\$3,924	\$4,181
	48 x 96 x 42	(2) Y	DCXL489642BU	\$3,863	\$4,087	\$4,368
	48 x 108 x 42	(2) Y	DCXL4810842BU	\$4,511	\$4,754	\$5,058
	* 48 x 120 x 42	(2) Y / (1) T	DCXL4812042BU	\$5,723	\$5,985	\$6,312
	* 48 x 144 x 42	(2) Y / (1) T	DCXL4814442BU	\$6,147	\$6,446	\$6,820

WIDTH 54" | HEIGHT 42" Use 60" wide sizes/pricing below- specify model # accordingly: (54" x 96" x 42" = DCXL549642BU)

WIDTH 60" | HEIGHT 42"

	60 x 72 x 42	(2) Y	DCXL607242BU	\$4,077	\$4,264	\$4,597
	60 x 78 x 42	(2) Y	DCXL607842BU	\$4,149	\$4,345	\$4,695
	60 x 84 x 42	(2) Y	DCXL608442BU	\$4,176	\$4,400	\$4,801
	60 x 96 x 42	(2) Y	DCXL609642BU	\$4,429	\$4,672	\$5,105
	60 x 108 x 42	(2) Y	DCXL6010842BU	\$5,123	\$5,385	\$5,852
	* 60 x 120 x 42	(2) Y / (1) T	DCXL6012042BU	\$6,143	\$6,423	\$6,924
	* 60 x 144 x 42	(2) Y / (1) T	DCXL6014442BU	\$6,518	\$6,836	\$7,402

• To specify 36" high tables, use 42" high sizes/pricing above & adjust model # accordingly: (60" x 84" x 36" = DCXL608436BU)



OPTIONAL:
Decorative Foot Extension in Black.
Add \$95.00 List- Per Double Leg.
Consult factory for other colors.

Standard Features:

- Adjustable leveling glides included.
- Power/Data options available, see Power/Data Solutions page.
- Wire management, grommets, etc. available, consult factory.

(*) = 2-Piece Top. (**) = 3-Piece Top Spline & Joint Fasteners included with table.

NOTE: Woodgrain pattern alignment between multiple tops not guaranteed.

HPL TOPS | 44 standard HPL finishes

METAL BASES | 11 powder coat finishes

EDGES | matching & coordinating finishes in the following options:

ABS 1: PVC-free impact resistant flat edge (S)

ABS 2: Multi-Ply "Plywood Look" flat vinyl edge (M)

ABS 3: Knife (KV), 1/2" Flat edge- bevel painted in a companion color

- Refer to edge code, above in (), when pricing below -

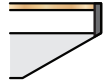

SIZE	BASE INFO #, Style	MODEL #	ABS 1 S	ABS 2 M	ABS 3 KV	
SOFT PENTAGON HEIGHT 29"						
	48 x 84 x 29	(2) Y	DCXL4884SP	\$3,575	\$3,780	\$4,038
	48 x 96 x 29	(2) Y	DCXL4896SP	\$3,749	\$3,973	\$4,254
	54 x 96 x 29	(2) Y	DCXL5496SP	\$4,313	\$4,555	\$4,989
	60 x 96 x 29	(2) Y	DCXL6096SP	\$4,313	\$4,555	\$4,989
SOFT PENTAGON HEIGHT 42"						
	48 x 84 x 42	(2) Y	DCXL488442SP	\$3,948	\$4,154	\$4,411
	48 x 96 x 42	(2) Y	DCXL489642SP	\$4,123	\$4,347	\$4,628
	54 x 96 x 42	(2) Y	DCXL549642SP	\$4,686	\$4,929	\$5,363
	60 x 96 x 42	(2) Y	DCXL609642SP	\$4,686	\$4,929	\$5,363
MEDIA SHARE (MS) HEIGHT 29"						
	48 x 81 x 29	(2) Y	DCXL4881MS	\$4,123	\$4,347	\$4,628
	54 x 92 x 29	(2) Y	DCXL5492MS	\$4,313	\$4,555	\$4,989
	60 x 102 x 29	(2) Y	DCXL60102MS	\$5,008	\$5,289	\$5,789
MEDIA SHARE (MS) HEIGHT 42"						
	48 x 81 x 42	(2) Y	DCXL488142MS	\$4,497	\$4,721	\$5,002
	54 x 92 x 42	(2) Y	DCXL549242MS	\$4,686	\$4,929	\$5,363
	60 x 102 x 42	(2) Y	DCXL6010242MS	\$5,382	\$5,662	\$6,163

• NOTE PRIOR TO ORDERING •

Larger size tops are heavy.

Verify site conditions for accessible delivery & install-
such as elevator access, building entry etc.



OPTIONAL:
Decorative Foot Extension in Black.
Add \$95.00 List- Per Double Leg.
Consult factory for other colors.

Standard Features:

- Adjustable leveling glides included.
- Power/Data options available, see Power/Data Solutions page.
- Wire management, grommets, etc. available, consult factory.

(*) = 2-Piece Top. (**) = 3-Piece Top Spline & Joint Fasteners included with table.

NOTE: Woodgrain pattern alignment between multiple tops not guaranteed.

HPL TOPS | 44 standard HPL finishes

METAL BASES | 11 powder coat finishes

EDGES | matching & coordinating finishes in the following options:

ABS 1: PVC-free impact resistant flat edge (S)

ABS 2: Multi-Ply "Plywood Look" flat vinyl edge (M)

ABS 3: Knife (KV), 1/2" Flat edge- bevel painted in a companion color

- Refer to edge code, above in (), when pricing below -

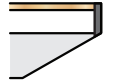

SIZE	BASE INFO #, Style	MODEL #	ABS 1 S	ABS 2 M	ABS 3 KV	
MEDIA PEAR HEIGHT 29"						
	54 x 72 x 29	(2) Y	DCXL5472MP	\$3,887	\$4,093	\$4,459
	60 x 72 x 29	(2) Y	DCXL6072MP	\$3,887	\$4,093	\$4,459
	54 x 84 x 29	(2) Y	DCXL5484MP	\$4,034	\$4,258	\$4,658
	60 x 84 x 29	(2) Y	DCXL6084MP	\$4,034	\$4,258	\$4,658
	54 x 96 x 29	(2) Y	DCXL5496MP	\$4,313	\$4,555	\$4,989
	60 x 96 x 29	(2) Y	DCXL6096MP	\$4,313	\$4,555	\$4,989
	54 x 108 x 29	(2) Y	DCXL54108MP	\$5,008	\$5,270	\$5,737
	60 x 108 x 29	(2) Y	DCXL60108MP	\$5,008	\$5,270	\$5,737
	* 54 x 120 x 29	(2) Y / (1) T	DCXL54120MP	\$5,957	\$6,237	\$6,738
	* 60 x 120 x 29	(2) Y / (1) T	DCXL60120MP	\$5,957	\$6,237	\$6,738

MEDIA PEAR HEIGHT 42"						
	54 x 72 x 42	(2) Y	DCXL547242MP	\$4,336	\$4,541	\$4,908
	60 x 72 x 42	(2) Y	DCXL607242MP	\$4,336	\$4,541	\$4,908
	54 x 84 x 42	(2) Y	DCXL548442MP	\$4,407	\$4,632	\$5,032
	60 x 84 x 42	(2) Y	DCXL608442MP	\$4,407	\$4,632	\$5,032
	54 x 96 x 42	(2) Y	DCXL549642MP	\$4,686	\$4,929	\$5,363
	60 x 96 x 42	(2) Y	DCXL609642MP	\$4,686	\$4,929	\$5,363
	54 x 108 x 42	(2) Y	DCXL5410842MP	\$5,382	\$5,644	\$6,111
	60 x 108 x 42	(2) Y	DCXL6010842MP	\$5,382	\$5,644	\$6,111
	* 54 x 120 x 42	(2) Y / (1) T	DCXL5412042MP	\$6,518	\$6,798	\$7,298
	* 60 x 120 x 42	(2) Y / (1) T	DCXL6012042MP	\$6,518	\$6,798	\$7,298

• **NOTE PRIOR TO ORDERING** •
Larger size tops are heavy.
Verify site conditions for accessible delivery & install-
such as elevator access, building entry etc.



OPTIONAL:
Decorative Foot Extension in Black.
Add \$95.00 List- Per Double Leg.
Consult factory for other colors.

Standard Features:

- Adjustable leveling glides included.
- Power/Data options available, see Power/Data Solutions page.
- Wire management, grommets, etc. available, consult factory.

(*) = 2-Piece Top. (**) = 3-Piece Top Spline & Joint Fasteners included with table.

NOTE: Woodgrain pattern alignment between multiple tops not guaranteed.

HPL TOPS | 44 standard HPL finishes

METAL BASES | 11 powder coat finishes

EDGES | matching & coordinating finishes in the following options:

ABS 1: PVC-free impact resistant flat edge (S)

ABS 2: Multi-Ply "Plywood Look" flat vinyl edge (M)

ABS 3: Knife (KV), 1/2" Flat edge- bevel painted in a companion color

- Refer to edge code, above in (), when pricing below -

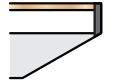

SIZE	BASE INFO #, Style	MODEL #	ABS 1 S	ABS 2 M	ABS 3 KV	
MEDIA WEDGE HEIGHT 29"						
	54 x 72 x 29	(2) Y	DCXL5472MW	\$3,887	\$4,093	\$4,459
	60 x 72 x 29	(2) Y	DCXL6072MW	\$3,887	\$4,093	\$4,459
	54 x 84 x 29	(2) Y	DCXL5484MW	\$4,034	\$4,258	\$4,658
	60 x 84 x 29	(2) Y	DCXL6084MW	\$4,034	\$4,258	\$4,658
	54 x 96 x 29	(2) Y	DCXL5496MW	\$4,313	\$4,555	\$4,989
	60 x 96 x 29	(2) Y	DCXL6096MW	\$4,313	\$4,555	\$4,989
	54 x 108 x 29	(2) Y	DCXL54108MW	\$5,008	\$5,270	\$5,737
	60 x 108 x 29	(2) Y	DCXL60108MW	\$5,008	\$5,270	\$5,737
	* 54 x 120 x 29	(2) Y / (1) T	DCXL54120MW	\$5,957	\$6,237	\$6,738
	* 60 x 120 x 29	(2) Y / (1) T	DCXL60120MW	\$5,957	\$6,237	\$6,738

MEDIA WEDGE HEIGHT 42"						
	54 x 72 x 42	(2) Y	DCXL547242MW	\$4,336	\$4,541	\$4,908
	60 x 72 x 42	(2) Y	DCXL607242MW	\$4,336	\$4,541	\$4,908
	54 x 84 x 42	(2) Y	DCXL548442MW	\$4,407	\$4,632	\$5,032
	60 x 84 x 42	(2) Y	DCXL608442MW	\$4,407	\$4,632	\$5,032
	54 x 96 x 42	(2) Y	DCXL549642MW	\$4,686	\$4,929	\$5,363
	60 x 96 x 42	(2) Y	DCXL609642MW	\$4,686	\$4,929	\$5,363
	54 x 108 x 42	(2) Y	DCXL5410842MW	\$5,382	\$5,644	\$6,111
	60 x 108 x 42	(2) Y	DCXL6010428MW	\$5,382	\$5,644	\$6,111
	* 54 x 120 x 42	(2) Y / (1) T	DCXL5412042MW	\$6,518	\$6,798	\$7,298
	* 60 x 120 x 42	(2) Y / (1) T	DCXL6012042MW	\$6,518	\$6,798	\$7,298

• **NOTE PRIOR TO ORDERING** •
Larger size tops are heavy.
Verify site conditions for accessible delivery & install-
such as elevator access, building entry etc.



SLALOM SERIES



Standard Features:

- Adjustable leveling glides included.
- Power/Data options available, consult factory.
- For additional base options (casters, flip top, etc.), consult factory.

HPL TOPS | 44 standard HPL finishes

METAL BASES | 11 powder coat finishes

EDGES | matching & coordinating finishes in the following options:

ABS 1: PVC-free impact resistant flat edge (S)

ABS 2: Multi-Ply "Plywood Look" flat vinyl edge (M)

ABS 3: Knife (KV), 1/2" Flat edge- bevel painted in a companion color

- Refer to edge code, above in (), when pricing below -

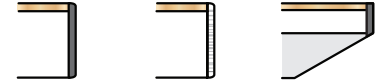

	SIZE	BASE INFO #, Style	MODEL #	ABS 1 S	ABS 2 M	ABS 3 KV
ROUND TOP CAFE HEIGHT 42" H.						
	24" Dia. x 42	(1) X-Base	TSLRX2442	\$738	\$796	\$814
	30" Dia. x 42	(1) X-Base	TSLRX3042	\$821	\$895	\$917
	36" Dia. x 42	(1) X-Base	TSLRX3642	\$928	\$1,016	\$1,043
	42" Dia. x 42	(1) X-Base	TSLRX4242	\$1,047	\$1,149	\$1,181
	48" Dia. x 42	(1) X-Base	TSLRX4842	\$1,160	\$1,277	\$1,314
	54" Dia. x 42	(1) X-Base	TSLRX5442	\$1,278	\$1,410	\$1,451
SQUARE TOP CAFE HEIGHT 42" H.						
	18 x 18 x 42	(1) X-Base	TLSX1842	\$685	\$741	\$758
	24 x 24 x 42	(1) X-Base	TLSX2442	\$738	\$813	\$836
	30 x 30 x 42	(1) X-Base	TLSX3042	\$821	\$915	\$943
	36 x 36 x 42	(1) X-Base	TLSX3642	\$951	\$1,063	\$1,098
	42 x 42 x 42	(1) X-Base	TLSX4242	\$1,112	\$1,243	\$1,283
ROUND TOP SEATED HEIGHT 29" H.						
	24" Dia. x 29	(1) X-Base	TSLRX2429	\$677	\$736	\$754
	30" Dia. x 29	(1) X-Base	TSLRX3029	\$765	\$838	\$861
	36" Dia. x 29	(1) X-Base	TSLRX3629	\$873	\$961	\$988
	42" Dia. x 29	(1) X-Base	TSLRX4229	\$990	\$1,093	\$1,124
	48" Dia. x 29	(1) X-Base	TSLRX4829	\$1,103	\$1,221	\$1,257
	54" Dia. x 29	(1) X-Base	TSLRX5429	\$1,229	\$1,361	\$1,402
SQUARE TOP SEATED HEIGHT 29" H.						
	18 x 18 x 29	(1) X-Base	TLSX1829	\$625	\$681	\$698
	24 x 24 x 29	(1) X-Base	TLSX2429	\$677	\$752	\$775
	30 x 30 x 29	(1) X-Base	TLSX3029	\$765	\$858	\$887
	36 x 36 x 29	(1) X-Base	TLSX3629	\$894	\$1,006	\$1,041
	42 x 42 x 29	(1) X-Base	TLSX4229	\$1,059	\$1,190	\$1,230



HPL TOPS | 44 standard HPL finishes

METAL BASES | 11 powder coat finishes

EDGES | matching & coordinating finishes in the following options:

ABS 1: PVC-free impact resistant flat edge (S)

ABS 2: Multi-Ply "Plywood Look" flat vinyl edge (M)

ABS 3: Knife (KV), 1/2" Flat edge- bevel painted in a companion color

- Refer to edge code, above in (), when pricing below -

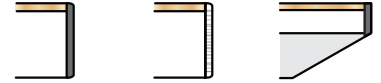

Standard Features:

- Adjustable leveling glides included.
- Power/Data options available, see Power/Data Solutions page.
- For additional base options (casters, flip top, folding, etc.), consult factory.

NOTE: See next page for "Mobile Flip Top" Tables.

- Modesty panel, wire management, grommets, etc. available, consult factory.

SIZE	BASE INFO #, Style	MODEL #	ABS 1 S	ABS 2 M	ABS 3 KV	
RECTANGULAR TABLES						
	18 x 42 x 29	(2) T-Base	TSL1842	\$743	\$836	\$865
	18 x 48 x 29	(2) T-Base	TSL1848	\$774	\$877	\$909
	18 x 60 x 29	(2) T-Base	TSL1860	\$894	\$1,015	\$1,053
	18 x 72 x 29	(2) T-Base	TSL1872	\$939	\$1,079	\$1,122
	18 x 84 x 29	(2) T-Base	TSL1884	\$1,003	\$1,162	\$1,211
	18 x 96 x 29	(2) T-Base	TSL1896	\$1,046	\$1,224	\$1,278
	20 x 42 x 29	(2) T-Base	TSL2042	\$780	\$877	\$907
	20 x 48 x 29	(2) T-Base	TSL2048	\$801	\$907	\$939
	20 x 60 x 29	(2) T-Base	TSL2060	\$918	\$1,042	\$1,081
	20 x 72 x 29	(2) T-Base	TSL2072	\$964	\$1,108	\$1,152
	20 x 84 x 29	(2) T-Base	TSL2084	\$1,035	\$1,197	\$1,247
	20 x 96 x 29	(2) T-Base	TSL2096	\$1,079	\$1,260	\$1,315
24 x 42 x 29	(2) T-Base	TSL2442	\$823	\$926	\$957	
24 x 48 x 29	(2) T-Base	TSL2448	\$843	\$955	\$990	
24 x 60 x 29	(2) T-Base	TSL2460	\$963	\$1,094	\$1,134	
24 x 72 x 29	(2) T-Base	TSL2472	\$1,012	\$1,161	\$1,207	
24 x 84 x 29	(2) T-Base	TSL2484	\$1,100	\$1,268	\$1,320	
24 x 96 x 29	(2) T-Base	TSL2496	\$1,148	\$1,335	\$1,392	
30 x 42 x 29	(2) T-Base	TSL3042	\$943	\$1,055	\$1,089	
30 x 48 x 29	(2) T-Base	TSL3048	\$964	\$1,086	\$1,123	
30 x 60 x 29	(2) T-Base	TSL3060	\$1,086	\$1,226	\$1,270	
30 x 72 x 29	(2) T-Base	TSL3072	\$1,148	\$1,307	\$1,356	
30 x 84 x 29	(2) T-Base	TSL3084	\$1,242	\$1,420	\$1,475	
30 x 96 x 29	(2) T-Base	TSL3096	\$1,276	\$1,473	\$1,533	
36 x 42 x 29	(2) T-Base	TSL3642	\$1,007	\$1,128	\$1,166	
36 x 48 x 29	(2) T-Base	TSL3648	\$1,036	\$1,167	\$1,207	
36 x 60 x 29	(2) T-Base	TSL3660	\$1,173	\$1,323	\$1,369	
36 x 72 x 29	(2) T-Base	TSL3672	\$1,250	\$1,418	\$1,470	
36 x 84 x 29	(2) T-Base	TSL3684	\$1,328	\$1,515	\$1,572	
36 x 96 x 29	(2) T-Base	TSL3696	\$1,381	\$1,587	\$1,650	

VIDEO CONFERENCE SHAPE TABLES
A D W H

THE VIDEO CONFERENCING SHAPE (-VC) CAN BE USED TO CREATE MANY CONFIGURATIONS, (BELOW LEFT)
OVERALL SIZE OF TABLE (D x W) LISTED IS NOMINAL AND MAY VARY +/- 1/2"

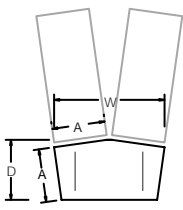

20 x 22 x 42 x 29	(2) T-Base	TSL2242-VC	\$977	\$1,072	\$1,101
24 x 27 x 50 x 29	(2) T-Base	TSL2750-VC	\$1,067	\$1,180	\$1,215
30 x 34 x 61 x 29	(2) T-Base	TSL3461-VC	\$1,323	\$1,464	\$1,507
36 x 41 x 73 x 29	(2) T-Base	TSL4173-VC	\$1,506	\$1,675	\$1,727



HPL TOPS | 44 standard HPL finishes

METAL BASES | 11 powder coat finishes

EDGES | matching & coordinating finishes in the following options:

ABS 1: PVC-free impact resistant flat edge (S)

ABS 2: Multi-Ply "Plywood Look" flat vinyl edge (M)

ABS 3: Knife (KV), 1/2" Flat edge- bevel painted in a companion color

- Refer to edge code, above in (), when pricing below -



Standard Features:

- Single lever flip top feature.
- 2" Locking casters included. (Specify for hard floor or carpeted areas)
- Power/Data options available, see Power/Data Solutions page.
- Modesty panel, wire management, grommets, etc. available, consult factory.

SIZE	BASE INFO #, Style	MODEL #	ABS 1 S	ABS 2 M	ABS 3 KV	
RECTANGULAR TABLES WITH FLIP TOP MECHANISM						
	18 x 42 x 29	(2) T-Base	TSL1842-FL	\$1,168	\$1,262	\$1,290
	18 x 48 x 29	(2) T-Base	TSL1848-FL	\$1,200	\$1,302	\$1,334
	18 x 60 x 29	(2) T-Base	TSL1860-FL	\$1,319	\$1,441	\$1,478
	18 x 72 x 29	(2) T-Base	TSL1872-FL	\$1,365	\$1,505	\$1,548
	18 x 84 x 29	(2) T-Base	TSL1884-FL	\$1,429	\$1,588	\$1,637
	18 x 96 x 29	(2) T-Base	TSL1896-FL	\$1,472	\$1,649	\$1,704
	20 x 42 x 29	(2) T-Base	TSL2042-FL	\$1,206	\$1,303	\$1,332
	20 x 48 x 29	(2) T-Base	TSL2048-FL	\$1,226	\$1,332	\$1,365
	20 x 60 x 29	(2) T-Base	TSL2060-FL	\$1,343	\$1,468	\$1,506
	20 x 72 x 29	(2) T-Base	TSL2072-FL	\$1,390	\$1,533	\$1,577
	20 x 84 x 29	(2) T-Base	TSL2084-FL	\$1,460	\$1,622	\$1,672
	20 x 96 x 29	(2) T-Base	TSL2096-FL	\$1,504	\$1,685	\$1,741
	24 x 42 x 29	(2) T-Base	TSL2442-FL	\$1,249	\$1,351	\$1,383
	24 x 48 x 29	(2) T-Base	TSL2448-FL	\$1,269	\$1,381	\$1,415
	24 x 60 x 29	(2) T-Base	TSL2460-FL	\$1,388	\$1,519	\$1,559
	24 x 72 x 29	(2) T-Base	TSL2472-FL	\$1,437	\$1,587	\$1,633
	24 x 84 x 29	(2) T-Base	TSL2484-FL	\$1,526	\$1,694	\$1,746
	24 x 96 x 29	(2) T-Base	TSL2496-FL	\$1,573	\$1,760	\$1,818
	30 x 42 x 29	(2) T-Base	TSL3042-FL	\$1,368	\$1,480	\$1,515
	30 x 48 x 29	(2) T-Base	TSL3048-FL	\$1,390	\$1,511	\$1,548
30 x 60 x 29	(2) T-Base	TSL3060-FL	\$1,512	\$1,652	\$1,695	
30 x 72 x 29	(2) T-Base	TSL3072-FL	\$1,573	\$1,732	\$1,781	
30 x 84 x 29	(2) T-Base	TSL3084-FL	\$1,668	\$1,845	\$1,900	
30 x 96 x 29	(2) T-Base	TSL3096-FL	\$1,702	\$1,898	\$1,959	
36 x 42 x 29	(2) T-Base	TSL3642-FL	\$1,432	\$1,554	\$1,591	
36 x 48 x 29	(2) T-Base	TSL3648-FL	\$1,461	\$1,592	\$1,632	
36 x 60 x 29	(2) T-Base	TSL3660-FL	\$1,599	\$1,748	\$1,794	
36 x 72 x 29	(2) T-Base	TSL3672-FL	\$1,675	\$1,844	\$1,895	
36 x 84 x 29	(2) T-Base	TSL3684-FL	\$1,754	\$1,940	\$1,998	
36 x 96 x 29	(2) T-Base	TSL3696-FL	\$1,806	\$2,012	\$2,075	

VIDEO CONFERENCE SHAPE TABLES WITH FLIP TOP MECHANISM THE VIDEO CONFERENCING SHAPE (-VC) CAN BE USED TO CREATE MANY CONFIGURATIONS (BELOW LEFT) OVERALL SIZE OF TABLE (D X W) LISTED IS NOMINAL AND MAY VARY +/- 1/2"

A	D	W	H			
	20 x 22 x 42 x 29	(2) T-Base	TSL2242-VC-FL	\$1,402	\$1,497	\$1,526
	24 x 27 x 50 x 29	(2) T-Base	TSL2750-VC-FL	\$1,492	\$1,606	\$1,641
	30 x 34 x 61 x 29	(2) T-Base	TSL3461-VC-FL	\$1,749	\$1,889	\$1,933
	36 x 41 x 73 x 29	(2) T-Base	TSL4173-VC-FL	\$1,931	\$2,100	\$2,152



HPL TOPS | 44 standard HPL finishes

METAL BASES | 11 powder coat finishes

EDGES | matching & coordinating finishes in the following options:

ABS 1: PVC-free impact resistant flat edge (S)

ABS 2: Multi-Ply "Plywood Look" flat vinyl edge (M)

ABS 3: Knife (KV), 1/2" Flat edge- bevel painted in a companion color

- Refer to edge code, above in (), when pricing below -

Standard Features:

- Adjustable leveling glides included.
- Power/Data options available, see Power/Data Solutions page.
- Wire management, grommets, etc. available, consult factory.

(*) Refers to a 2-Piece Top. Spline and Joint Fasteners included with table.

NOTE: Woodgrain pattern alignment between two tops not guaranteed.

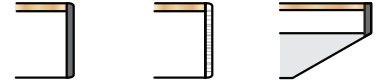

SIZE	BASE INFO #, Style	MODEL #	ABS 1 S	ABS 2 M	ABS 3 KV	
ROUND TOP CAFE HEIGHT 42" H.						
	48" Dia. x 42	(1) 4-Post X-Base	CSL4842RX	\$1,755	\$1,873	\$1,909
	54" Dia. x 42	(1) 4-Post X-Base	CSL5442RX	\$1,892	\$2,024	\$2,065
	60" Dia. x 42	(1) 4-Post X-Base	CSL6042RX	\$2,180	\$2,326	\$2,371
SQUARE TOP CAFE HEIGHT 42" H.						
	48 x 48 x 42	(1) 4-Post X-Base	CSL4842SX	\$1,743	\$1,892	\$1,938
	54 x 54 x 42	(1) 4-Post X-Base	CSL5442SX	\$1,836	\$2,004	\$2,147
	60 x 60 x 42	(1) 4-Post X-Base	CSL6042SX	\$2,123	\$2,310	\$2,468
ROUND TOP SEATED HEIGHT 29"H.						
	48" Dia. x 29	(1) 4-Post X-Base	CSL4829RX	\$1,544	\$1,661	\$1,697
	54" Dia. x 29	(1) 4-Post X-Base	CSL5429RX	\$1,647	\$1,779	\$1,819
	60" Dia. x 29	(1) 4-Post X-Base	CSL6029RX	\$1,968	\$2,115	\$2,160
	* 72" Dia. x 29	(1) 4-Post X-Base	CSL7229RX	\$2,622	\$2,798	\$2,852
SQUARE TOP SEATED HEIGHT 29" H.						
	48 x 48 x 29	(1) 4-Post X-Base	CSL4829SX	\$1,531	\$1,680	\$1,726
	54 x 54 x 29	(1) 4-Post X-Base	CSL5429SX	\$1,591	\$1,759	\$1,901
	60 x 60 x 29	(1) 4-Post X-Base	CSL6029SX	\$1,912	\$2,099	\$2,257
	* 72 x 72 x 29	(1) 4-Post X-Base	CSL7229SX	\$2,622	\$2,846	\$3,036



HPL TOPS | 44 standard HPL finishes

METAL BASES | 11 powder coat finishes

EDGES | matching & coordinating finishes in the following options:

ABS 1: PVC-free impact resistant flat edge (S)

ABS 2: Multi-Ply "Plywood Look" flat vinyl edge (M)

ABS 3: Knife (KV), 1/2" Flat edge- bevel painted in a companion color

- Refer to edge code, above in (), when pricing below -

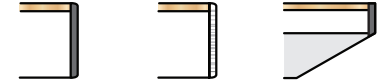

Standard Features:

- Adjustable leveling glides included.
- Power/Data options available, consult factory
- Wire management, grommets, etc. available, consult factory.

SIZE	BASE INFO #, Style	MODEL #	ABS 1 S	ABS 2 M	ABS 3 KV	
ROUND TOP SIDE TABLE 22" H.						
	24" Dia. x 22	(1) X-Base	OSLR2422	\$856	\$915	\$933
	30" Dia. x 22	(1) X-Base	OSLR3022	\$947	\$1,021	\$1,043
	36" Dia. x 22	(1) X-Base	OSLR3622	\$1,034	\$1,122	\$1,149
	42" Dia. x 22	(1) X-Base	OSLR4222	\$1,276	\$1,379	\$1,410
	48" Dia. x 22	(1) X-Base	OSLR4822	\$1,368	\$1,485	\$1,521
SQUARE TOP SIDE TABLE 22" H.						
	24 x 24 x 22	(1) X-Base	OSLS2422	\$856	\$931	\$954
	30 x 30 x 22	(1) X-Base	OSLS3022	\$947	\$1,041	\$1,069
	36 x 36 x 22	(1) X-Base	OSLS3622	\$1,034	\$1,146	\$1,181
	42 x 42 x 22	(1) X-Base	OSLS4222	\$1,276	\$1,407	\$1,447
	48 x 48 x 22	(1) X-Base	OSLS4822	\$1,368	\$1,517	\$1,563
ROUND TOP COFFEE TABLE 17" H.						
	24" Dia. x 17	(1) X-Base	OSLR2417	\$844	\$902	\$920
	30" Dia. x 17	(1) X-Base	OSLR3017	\$935	\$1,008	\$1,031
	36" Dia. x 17	(1) X-Base	OSLR3617	\$1,021	\$1,110	\$1,137
	42" Dia. x 17	(1) X-Base	OSLR4217	\$1,263	\$1,366	\$1,398
	48" Dia. x 17	(1) X-Base	OSLR4817	\$1,355	\$1,473	\$1,509
SQUARE TOP COFFEE TABLE 17" H.						
	24 x 24 x 17	(1) X-Base	OSLS2417	\$844	\$918	\$941
	30 x 30 x 17	(1) X-Base	OSLS3017	\$935	\$1,028	\$1,057
	36 x 36 x 17	(1) X-Base	OSLS3617	\$1,021	\$1,134	\$1,168
	42 x 42 x 17	(1) X-Base	OSLS4217	\$1,263	\$1,394	\$1,434
	48 x 48 x 17	(1) X-Base	OSLS4817	\$1,355	\$1,505	\$1,551



SLALOM XL SERIES



CONTENTS

Overview 53

TABLE PRICING

Rectangle 54

Wedge 56

Boat 58

Diamond 60

Bow End 62

Oval 64

Racetrack 65

Boat-R..... 67

Soft Wedge 69

Bullet 71

Soft Pentagon..... 72

Media Share 72

Media Pear 73

Media Wedge 74



Slalom XL table collection by Primeway embodies an aesthetic framework of double “Y” bases bridged by stretcher bars. For longer lengths, matching double “T” bases are incorporated for extra support. Elongated & angled feet complete the look for a distinct elevated effect.

Base Style | ELEVATED DOUBLE COLUMN Y-BASES, LINKED BY STRETCHER BARS, TABLES 120"+ INCLUDE MATCHING T-BASES



- Elevated feet
- 3 Heights: 29", 36", 42"
- 11 powder coat finishes
- Leveling glides included

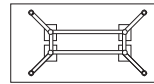

BASE: (2) Y
LENGTHS: up to 108"
TOP: 1 piece

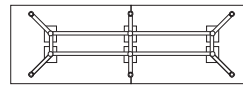

BASE: (2) Y, (1) T
LENGTHS: 120" & 144"
TOP: 2 pieces

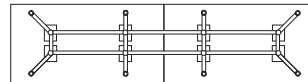

BASE: (2) Y, (2) T
LENGTHS: 156", 168" & 180"
TOP: 2 pieces

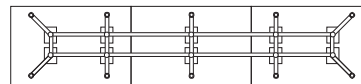

BASE: (2) Y, (3) T
LENGTHS: 192" - 240"
TOP: 3 pieces

Accessories | ROUND GROMMET, HOOK, WIRE MANAGEMENT (SEE PRIMEWAY ACCESSORIES PAGE FOR: POWER DATA OPTIONS)



Model#	Accessory Option	List Price
TFG	Round Grommet (Black, Grey, White)	\$25
UBH	Black Hook, Under Mount (near edge)	\$35
WMH	Wire Management Holes (2) in 1 vertical column specify base & column(s) (based on site conditions)	\$75

*SPECIFY EXACT LOCATION FOR ANY ABOVE OPTION

14 Shapes | RECTANGLE, RACETRACK, WEDGE, BOAT, BULLET, SOFT WEDGE, SOFT PENTAGON, BOAT-R, DIAMOND, BOW END, MEDIA PEAR, MEDIA WEDGE, MEDIA SHARE, OVAL

- 44 Standard HPL Finishes
- 3 Edge Options
- Top Thickness 1-1/4" (+/- based on edge detail)
- 1 Piece Tops up to 108", 2 Piece Tops 120" - 180", 3 Piece Tops 192" - 240"
(Alignment of woodgrain patterns with 2 & 3 piece tops cannot be guaranteed, draw-tight hardware & wafers are included for installation)
- Stiffener Bars Included with Tables 84" & Up

See "Primeway Standard Color Card" for All Finish Specifications & Swatches



SLALOM XL | RECTANGLE | HEIGHT: 29"



HPL TOPS | 44 standard HPL finishes

METAL BASES | 11 powder coat finishes

EDGES | matching & coordinating finishes in the following options:

ABS 1: PVC-free impact resistant flat edge (S)

ABS 2: Multi-Ply "Plywood Look" flat vinyl edge (M)

ABS 3: Knife (KV), 1/2" Flat edge- bevel painted in a companion color

- Refer to edge code, above in (), when pricing below -

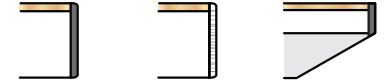

Standard Features:

- Adjustable leveling glides included.
- Power/Data options available, see Power/Data Solutions page.
- Wire management, grommets, etc. available, consult factory.

(*) = 2-Piece Top. (**) = 3-Piece Top Spline & Joint Fasteners included with table.

NOTE: Woodgrain pattern alignment between multiple tops not guaranteed.

SIZE	BASE INFO #, Style	MODEL #	ABS 1 S	ABS 2 M	ABS 3 KV	
WIDTH 42" HEIGHT 29"						
	42 x 72 x 29	(2) Y	SLXL4272SQ	\$2,607	\$2,784	\$3,007
	42 x 84 x 29	(2) Y	SLXL4284SQ	\$2,856	\$3,065	\$3,326
	42 x 96 x 29	(2) Y	SLXL4296SQ	\$3,094	\$3,309	\$3,578

• For additional table sizes at 42" wide, use 48" wide sizes/pricing below- specify model # accordingly: (42" x 144" x 29" = SLXL42144SQ)

WIDTH 48" HEIGHT 29"						
	48 x 84 x 29	(2) Y	SLXL4884SQ	\$3,267	\$3,472	\$3,730
	48 x 96 x 29	(2) Y	SLXL4896SQ	\$3,440	\$3,665	\$3,945
	48 x 108 x 29	(2) Y	SLXL48108SQ	\$4,088	\$4,331	\$4,635
	* 48 x 120 x 29	(2) Y / (1) T	SLXL48120SQ	\$5,165	\$5,427	\$5,754
	* 48 x 144 x 29	(2) Y / (1) T	SLXL48144SQ	\$5,589	\$5,888	\$6,262
	* 48 x 156 x 29	(2) Y / (2) T	SLXL48156SQ	\$6,916	\$7,233	\$7,631
	* 48 x 168 x 29	(2) Y / (2) T	SLXL48168SQ	\$6,962	\$7,299	\$7,720
	* 48 x 180 x 29	(2) Y / (2) T	SLXL48180SQ	\$7,306	\$7,661	\$8,106
	** 48 x 192 x 29	(2) Y / (3) T	SLXL48192SQ	\$8,342	\$8,716	\$9,184
	** 48 x 204 x 29	(2) Y / (3) T	SLXL48204SQ	\$8,751	\$9,144	\$9,635
	** 48 x 216 x 29	(2) Y / (4) T	SLXL48216SQ	\$8,796	\$9,207	\$9,721
	** 48 x 228 x 29	(2) Y / (4) T	SLXL48228SQ	\$9,347	\$9,777	\$10,316
	** 48 x 240 x 29	(2) Y / (4) T	SLXL48240SQ	\$9,761	\$10,209	\$10,771

WIDTH 54" | HEIGHT 29" Use 60" wide sizes/pricing below- specify model # accordingly: (54" x 96" x 29" = SLXL5496SQ)

WIDTH 60" HEIGHT 29"						
	60 x 84 x 29	(2) Y	SLXL6084SQ	\$3,733	\$3,957	\$4,358
	60 x 96 x 29	(2) Y	SLXL6096SQ	\$4,015	\$4,258	\$4,691
	60 x 108 x 29	(2) Y	SLXL60108SQ	\$4,709	\$4,971	\$5,438
	* 60 x 120 x 29	(2) Y / (1) T	SLXL60120SQ	\$5,594	\$5,874	\$6,374
	* 60 x 144 x 29	(2) Y / (1) T	SLXL60144SQ	\$5,969	\$6,286	\$6,853
	* 60 x 156 x 29	(2) Y / (2) T	SLXL60156SQ	\$7,359	\$7,695	\$8,296
	* 60 x 168 x 29	(2) Y / (2) T	SLXL60168SQ	\$7,546	\$7,902	\$8,535
	* 60 x 180 x 29	(2) Y / (2) T	SLXL60180SQ	\$7,828	\$8,202	\$8,869
	** 60 x 192 x 29	(2) Y / (3) T	SLXL60192SQ	\$9,005	\$9,397	\$10,097
	** 60 x 204 x 29	(2) Y / (3) T	SLXL60204SQ	\$9,347	\$9,758	\$10,492
	** 60 x 216 x 29	(2) Y / (4) T	SLXL60216SQ	\$9,535	\$9,964	\$10,731
	** 60 x 228 x 29	(2) Y / (4) T	SLXL60228SQ	\$10,021	\$10,470	\$11,270
	** 60 x 240 x 29	(2) Y / (4) T	SLXL60240SQ	\$10,577	\$11,044	\$11,878

SLALOM XL | RECTANGLE

HEIGHT: 42", FOR 36" SEE NOTE AT BOTTOM OF PAGE



HPL TOPS | 44 standard HPL finishes

METAL BASES | 11 powder coat finishes

EDGES | matching & coordinating finishes in the following options:

ABS 1: PVC-free impact resistant flat edge (S)

ABS 2: Multi-Ply "Plywood Look" flat vinyl edge (M)

ABS 3: Knife (KV), 1/2" Flat edge- bevel painted in a companion color

- Refer to edge code, above in (), when pricing below -

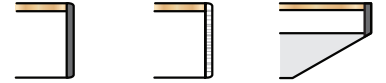

Standard Features:

- Adjustable leveling glides included.
- Power/Data options available, see Power/Data Solutions page.
- Wire management, grommets, etc. available, consult factory.

(*) = 2-Piece Top. (**) = 3-Piece Top Spline & Joint Fasteners included with table.

NOTE: Woodgrain pattern alignment between multiple tops not guaranteed.

SIZE	BASE INFO #, Style	MODEL #	ABS 1 S	ABS 2 M	ABS 3 KV	
WIDTH 42" HEIGHT 42"						
	42 x 72 x 42	(2) Y	SLXL4272S42Q	\$2,981	\$3,158	\$3,381
	42 x 84 x 42	(2) Y	SLXL428442SQ	\$3,230	\$3,439	\$3,700
	42 x 96 x 42	(2) Y	SLXL429642SQ	\$3,468	\$3,683	\$3,952

• For additional tables at 42" wide, use 48" wide sizes/pricing below- specify model # accordingly: (42" x 144" x 42" = SLXL4214442SQ)

SIZE	BASE INFO #, Style	MODEL #	ABS 1 S	ABS 2 M	ABS 3 KV	
WIDTH 48" HEIGHT 42"						
	48 x 84 x 42	(2) Y	SLXL488442SQ	\$3,641	\$3,846	\$4,104
	48 x 96 x 42	(2) Y	SLXL489642SQ	\$3,814	\$4,038	\$4,319
	48 x 108 x 42	(2) Y	SLXL4810842SQ	\$4,462	\$4,705	\$5,009
	* 48 x 120 x 42	(2) Y / (1) T	SLXL4812042SQ	\$5,726	\$5,987	\$6,315
	* 48 x 144 x 42	(2) Y / (1) T	SLXL4814442SQ	\$6,150	\$6,449	\$6,823
	* 48 x 156 x 42	(2) Y / (2) T	SLXL4815642SQ	\$7,663	\$7,981	\$8,379
	* 48 x 168 x 42	(2) Y / (2) T	SLXL4816842SQ	\$7,710	\$8,046	\$8,467
	* 48 x 180 x 42	(2) Y / (2) T	SLXL4818042SQ	\$8,054	\$8,409	\$8,854
	** 48 x 192 x 42	(2) Y / (3) T	SLXL4819242SQ	\$9,277	\$9,651	\$10,119
	** 48 x 204 x 42	(2) Y / (3) T	SLXL4820442SQ	\$9,686	\$10,078	\$10,570
	** 48 x 216 x 42	(2) Y / (4) T	SLXL4821642SQ	\$9,731	\$10,141	\$10,655
	** 48 x 228 x 42	(2) Y / (4) T	SLXL4822842SQ	\$10,282	\$10,712	\$11,250
	** 48 x 240 x 42	(2) Y / (4) T	SLXL4824042SQ	\$10,695	\$11,144	\$11,705

WIDTH 54" | HEIGHT 42" Use 60" wide sizes/pricing below- specify model # accordingly: (54" x 96" x 42" = SLXL549642SQ)

SIZE	BASE INFO #, Style	MODEL #	ABS 1 S	ABS 2 M	ABS 3 KV	
WIDTH 60" HEIGHT 42"						
	60 x 84 x 42	(2) Y	SLXL608442SQ	\$4,107	\$4,331	\$4,731
	60 x 96 x 42	(2) Y	SLXL609642SQ	\$4,388	\$4,631	\$5,065
	60 x 108 x 42	(2) Y	SLXL6010842SQ	\$5,083	\$5,345	\$5,811
	* 60 x 120 x 42	(2) Y / (1) T	SLXL6012042SQ	\$6,154	\$6,435	\$6,935
	* 60 x 144 x 42	(2) Y / (1) T	SLXL6014442SQ	\$6,529	\$6,847	\$7,414
	* 60 x 156 x 42	(2) Y / (2) T	SLXL6015642SQ	\$8,107	\$8,443	\$9,043
	* 60 x 168 x 42	(2) Y / (2) T	SLXL6016842SQ	\$8,294	\$8,649	\$9,283
	* 60 x 180 x 42	(2) Y / (2) T	SLXL6018042SQ	\$8,576	\$8,949	\$9,616
	** 60 x 192 x 42	(2) Y / (3) T	SLXL6019242SQ	\$9,939	\$10,331	\$11,032
	** 60 x 204 x 42	(2) Y / (3) T	SLXL6020442SQ	\$10,282	\$10,693	\$11,426
	** 60 x 216 x 42	(2) Y / (4) T	SLXL6021642SQ	\$10,469	\$10,899	\$11,666
	** 60 x 228 x 42	(2) Y / (4) T	SLXL6022842SQ	\$10,956	\$11,404	\$12,205
	** 60 x 240 x 42	(2) Y / (4) T	SLXL6024042SQ	\$11,511	\$11,978	\$12,812

• To specify 36" high tables, use 42" high sizes/pricing above & adjust model # accordingly: (60" x 84" x 36" = SLXL608436SQ)



HPL TOPS | 44 standard HPL finishes

METAL BASES | 11 powder coat finishes

EDGES | matching & coordinating finishes in the following options:

ABS 1: PVC-free impact resistant flat edge (S)

ABS 2: Multi-Ply "Plywood Look" flat vinyl edge (M)

ABS 3: Knife (KV), 1/2" Flat edge- bevel painted in a companion color

- Refer to edge code, above in (), when pricing below -

Standard Features:

- Adjustable leveling glides included.
- Power/Data options available, see Power/Data Solutions page.
- Wire management, grommets, etc. available, consult factory.

(*) = 2-Piece Top. (**) = 3-Piece Top Spline & Joint Fasteners included with table.

NOTE: Woodgrain pattern alignment between multiple tops not guaranteed.



SIZE	BASE INFO #, Style	MODEL #	ABS 1 S	ABS 2 M	ABS 3 KV	
WIDTH 42" HEIGHT 29"						
	42 x 72 x 29	(2) Y	SLXL4272WD	\$2,866	\$3,043	\$3,266
	42 x 84 x 29	(2) Y	SLXL4284WD	\$3,115	\$3,324	\$3,585
	42 x 96 x 29	(2) Y	SLXL4296WD	\$3,353	\$3,568	\$3,837

• For additional table sizes at 42" wide, use 48" wide sizes/pricing below- specify model # accordingly: (42" x 144" x 29" = SLXL42144WD)

SIZE	BASE INFO #, Style	MODEL #	ABS 1 S	ABS 2 M	ABS 3 KV	
WIDTH 48" HEIGHT 29"						
	48 x 84 x 29	(2) Y	SLXL4884WD	\$3,526	\$3,731	\$3,988
	48 x 96 x 29	(2) Y	SLXL4896WD	\$3,699	\$3,923	\$4,204
	48 x 108 x 29	(2) Y	SLXL48108WD	\$4,347	\$4,590	\$4,894
	* 48 x 120 x 29	(2) Y / (1) T	SLXL48120WD	\$5,539	\$5,801	\$6,128
	* 48 x 144 x 29	(2) Y / (1) T	SLXL48144WD	\$5,963	\$6,262	\$6,636
	* 48 x 156 x 29	(2) Y / (2) T	SLXL48156WD	\$7,290	\$7,607	\$8,005
	* 48 x 168 x 29	(2) Y / (2) T	SLXL48168WD	\$7,336	\$7,672	\$8,094
	* 48 x 180 x 29	(2) Y / (2) T	SLXL48180WD	\$7,680	\$8,035	\$8,480
	** 48 x 192 x 29	(2) Y / (3) T	SLXL48192WD	\$8,716	\$9,090	\$9,558
	** 48 x 204 x 29	(2) Y / (3) T	SLXL48204WD	\$9,125	\$9,517	\$10,009
	** 48 x 216 x 29	(2) Y / (4) T	SLXL48216WD	\$9,170	\$9,581	\$10,094
	** 48 x 228 x 29	(2) Y / (4) T	SLXL48228WD	\$9,836	\$10,266	\$10,804
	** 48 x 240 x 29	(2) Y / (4) T	SLXL48240WD	\$10,249	\$10,698	\$11,260

WIDTH 54" | HEIGHT 29" Use 60" wide sizes/pricing below- specify model # accordingly: (54" x 96" x 29" = SLXL5496WD)

SIZE	BASE INFO #, Style	MODEL #	ABS 1 S	ABS 2 M	ABS 3 KV	
WIDTH 60" HEIGHT 29"						
	60 x 84 x 29	(2) Y	SLXL6084WD	\$3,992	\$4,216	\$4,616
	60 x 96 x 29	(2) Y	SLXL6096WD	\$4,273	\$4,516	\$4,950
	60 x 108 x 29	(2) Y	SLXL60108WD	\$4,968	\$5,230	\$5,696
	* 60 x 120 x 29	(2) Y / (1) T	SLXL60120WD	\$5,967	\$6,248	\$6,748
	* 60 x 144 x 29	(2) Y / (1) T	SLXL60144WD	\$6,342	\$6,660	\$7,227
	* 60 x 156 x 29	(2) Y / (2) T	SLXL60156WD	\$7,733	\$8,069	\$8,669
	* 60 x 168 x 29	(2) Y / (2) T	SLXL60168WD	\$7,920	\$8,275	\$8,909
	* 60 x 180 x 29	(2) Y / (2) T	SLXL60180WD	\$8,202	\$8,576	\$9,243
	** 60 x 192 x 29	(2) Y / (3) T	SLXL60192WD	\$9,378	\$9,771	\$10,471
	** 60 x 204 x 29	(2) Y / (3) T	SLXL60204WD	\$9,721	\$10,132	\$10,866
	** 60 x 216 x 29	(2) Y / (4) T	SLXL60216WD	\$9,908	\$10,338	\$11,105
	** 60 x 228 x 29	(2) Y / (4) T	SLXL60228WD	\$10,510	\$10,959	\$11,759
	** 60 x 240 x 29	(2) Y / (4) T	SLXL60240WD	\$11,065	\$11,533	\$12,366



HPL TOPS | 44 standard HPL finishes

METAL BASES | 11 powder coat finishes

EDGES | matching & coordinating finishes in the following options:

ABS 1: PVC-free impact resistant flat edge (S)

ABS 2: Multi-Ply "Plywood Look" flat vinyl edge (M)

ABS 3: Knife (KV), 1/2" Flat edge- bevel painted in a companion color

- Refer to edge code, above in (), when pricing below -

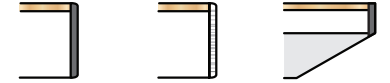

Standard Features:

- Adjustable leveling glides included.
- Power/Data options available, see Power/Data Solutions page.
- Wire management, grommets, etc. available, consult factory.

(*) = 2-Piece Top. (**) = 3-Piece Top Spline & Joint Fasteners included with table.

NOTE: Woodgrain pattern alignment between multiple tops not guaranteed.

SIZE	BASE INFO #, Style	MODEL #	ABS 1 S	ABS 2 M	ABS 3 KV	
WIDTH 42" HEIGHT 42"						
	42 x 72 x 42	(2) Y	SLXL427242WD	\$3,239	\$3,417	\$3,639
	42 x 84 x 42	(2) Y	SLXL428442WD	\$3,489	\$3,697	\$3,959
	42 x 96 x 42	(2) Y	SLXL429642WD	\$3,727	\$3,942	\$4,211

• For additional tables at 42" wide, use 48" wide sizes/pricing below- specify model # accordingly: (42" x 144" x 42" = SLXL4214442WD)

WIDTH 48" HEIGHT 42"						
	48 x 84 x 42	(2) Y	SLXL488442WD	\$3,899	\$4,105	\$4,362
	48 x 96 x 42	(2) Y	SLXL489642WD	\$4,073	\$4,297	\$4,578
	48 x 108 x 42	(2) Y	SLXL4810842WD	\$4,721	\$4,964	\$5,268
	* 48 x 120 x 42	(2) Y / (1) T	SLXL4812042WD	\$6,100	\$6,361	\$6,689
	* 48 x 144 x 42	(2) Y / (1) T	SLXL4814442WD	\$6,523	\$6,822	\$7,197
	* 48 x 156 x 42	(2) Y / (2) T	SLXL4815642WD	\$8,037	\$8,355	\$8,753
	* 48 x 168 x 42	(2) Y / (2) T	SLXL4816842WD	\$8,083	\$8,420	\$8,841
	* 48 x 180 x 42	(2) Y / (2) T	SLXL4818042WD	\$8,428	\$8,783	\$9,227
	** 48 x 192 x 42	(2) Y / (3) T	SLXL4819242WD	\$9,651	\$10,024	\$10,492
	** 48 x 204 x 42	(2) Y / (3) T	SLXL4820442WD	\$10,059	\$10,452	\$10,943
	** 48 x 216 x 42	(2) Y / (4) T	SLXL4821642WD	\$10,105	\$10,515	\$11,029
	** 48 x 228 x 42	(2) Y / (4) T	SLXL4822842WD	\$10,771	\$11,200	\$11,739
	** 48 x 240 x 42	(2) Y / (4) T	SLXL4824042WD	\$11,184	\$11,632	\$12,194

WIDTH 54" | HEIGHT 42" Use 60" wide sizes/pricing below- specify model # accordingly: (54" x 96" x 42" = SLXL549642WD)

WIDTH 60" HEIGHT 42"						
	60 x 84 x 42	(2) Y	SLXL608442WD	\$4,366	\$4,590	\$4,990
	60 x 96 x 42	(2) Y	SLXL609642WD	\$4,647	\$4,890	\$5,324
	60 x 108 x 42	(2) Y	SLXL6010842WD	\$5,342	\$5,603	\$6,070
	* 60 x 120 x 42	(2) Y / (1) T	SLXL6012042WD	\$6,528	\$6,808	\$7,309
	* 60 x 144 x 42	(2) Y / (1) T	SLXL6014442WD	\$6,903	\$7,221	\$7,788
	* 60 x 156 x 42	(2) Y / (2) T	SLXL6015642WD	\$8,480	\$8,817	\$9,417
	* 60 x 168 x 42	(2) Y / (2) T	SLXL6016842WD	\$8,668	\$9,023	\$9,656
	* 60 x 180 x 42	(2) Y / (2) T	SLXL6018042WD	\$8,949	\$9,323	\$9,990
	** 60 x 192 x 42	(2) Y / (3) T	SLXL6019242WD	\$10,313	\$10,705	\$11,406
	** 60 x 204 x 42	(2) Y / (3) T	SLXL6020442WD	\$10,655	\$11,066	\$11,800
	** 60 x 216 x 42	(2) Y / (4) T	SLXL6021642WD	\$10,843	\$11,273	\$12,040
	** 60 x 228 x 42	(2) Y / (4) T	SLXL6022842WD	\$11,444	\$11,893	\$12,693
	** 60 x 240 x 42	(2) Y / (4) T	SLXL6024042WD	\$12,000	\$12,467	\$13,301

• To specify 36" high tables, use 42" high sizes/pricing above & adjust model # accordingly: (60" x 84" x 36" = SLXL608436WD)



HPL TOPS | 44 standard HPL finishes

METAL BASES | 11 powder coat finishes

EDGES | matching & coordinating finishes in the following options:

ABS 1: PVC-free impact resistant flat edge (S)

ABS 2: Multi-Ply "Plywood Look" flat vinyl edge (M)

ABS 3: Knife (KV), 1/2" Flat edge- bevel painted in a companion color

- Refer to edge code, above in (), when pricing below -

Standard Features:

- Adjustable leveling glides included.
- Power/Data options available, see Power/Data Solutions page.
- Wire management, grommets, etc. available, consult factory.

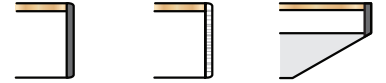

(*) = 2-Piece Top. (**) = 3-Piece Top Spline & Joint Fasteners included with table.

NOTE: Woodgrain pattern alignment between multiple tops not guaranteed.





SIZE	BASE INFO #, Style	MODEL #	ABS 1 S	ABS 2 M	ABS 3 KV	
WIDTH 42" HEIGHT 29"						
	42 x 72 x 29	(2) Y	SLXL4272BT	\$2,866	\$3,043	\$3,266
	42 x 84 x 29	(2) Y	SLXL4284BT	\$3,115	\$3,324	\$3,585
	42 x 96 x 29	(2) Y	SLXL4296BT	\$3,353	\$3,568	\$3,837

• For additional table sizes at 42" wide, use 48" wide sizes/pricing below- specify model # accordingly: (42" x 144" x 29" = SLXL42144BT)

SIZE	BASE INFO #, Style	MODEL #	ABS 1 S	ABS 2 M	ABS 3 KV	
WIDTH 48" HEIGHT 29"						
	48 x 84 x 29	(2) Y	SLXL4884BT	\$3,526	\$3,731	\$3,988
	48 x 96 x 29	(2) Y	SLXL4896BT	\$3,699	\$3,923	\$4,204
	48 x 108 x 29	(2) Y	SLXL48108BT	\$4,347	\$4,590	\$4,894
	* 48 x 120 x 29	(2) Y / (1) T	SLXL48120BT	\$5,539	\$5,801	\$6,128
	* 48 x 144 x 29	(2) Y / (1) T	SLXL48144BT	\$5,963	\$6,262	\$6,636
	* 48 x 156 x 29	(2) Y / (2) T	SLXL48156BT	\$7,290	\$7,607	\$8,005
	* 48 x 168 x 29	(2) Y / (2) T	SLXL48168BT	\$7,336	\$7,672	\$8,094
	* 48 x 180 x 29	(2) Y / (2) T	SLXL48180BT	\$7,680	\$8,035	\$8,480
	** 48 x 192 x 29	(2) Y / (3) T	SLXL48192BT	\$8,716	\$9,090	\$9,558
	** 48 x 204 x 29	(2) Y / (3) T	SLXL48204BT	\$9,125	\$9,517	\$10,009
	** 48 x 216 x 29	(2) Y / (4) T	SLXL48216BT	\$9,170	\$9,581	\$10,094
	** 48 x 228 x 29	(2) Y / (4) T	SLXL48228BT	\$9,836	\$10,266	\$10,804
	** 48 x 240 x 29	(2) Y / (4) T	SLXL48240BT	\$10,249	\$10,698	\$11,260

WIDTH 54" | HEIGHT 29" Use 60" wide sizes/pricing below- specify model # accordingly: (54" x 96" x 29" = SLXL5496BT)

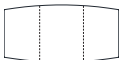
SIZE	BASE INFO #, Style	MODEL #	ABS 1 S	ABS 2 M	ABS 3 KV	
WIDTH 60" HEIGHT 29"						
	60 x 84 x 29	(2) Y	SLXL6084BT	\$3,992	\$4,216	\$4,616
	60 x 96 x 29	(2) Y	SLXL6096BT	\$4,273	\$4,516	\$4,950
	60 x 108 x 29	(2) Y	SLXL60108BT	\$4,968	\$5,230	\$5,696
	* 60 x 120 x 29	(2) Y / (1) T	SLXL60120BT	\$5,967	\$6,248	\$6,748
	* 60 x 144 x 29	(2) Y / (1) T	SLXL60144BT	\$6,342	\$6,660	\$7,227
	* 60 x 156 x 29	(2) Y / (2) T	SLXL60156BT	\$7,733	\$8,069	\$8,669
	* 60 x 168 x 29	(2) Y / (2) T	SLXL60168BT	\$7,920	\$8,275	\$8,909
	* 60 x 180 x 29	(2) Y / (2) T	SLXL60180BT	\$8,202	\$8,576	\$9,243
	** 60 x 192 x 29	(2) Y / (3) T	SLXL60192BT	\$9,378	\$9,771	\$10,471
	** 60 x 204 x 29	(2) Y / (3) T	SLXL60204BT	\$9,721	\$10,132	\$10,866
	** 60 x 216 x 29	(2) Y / (4) T	SLXL60216BT	\$9,908	\$10,338	\$11,105
	** 60 x 228 x 29	(2) Y / (4) T	SLXL60228BT	\$10,510	\$10,959	\$11,759
	** 60 x 240 x 29	(2) Y / (4) T	SLXL60240BT	\$11,065	\$11,533	\$12,366



HPL TOPS | 44 standard HPL finishes

METAL BASES | 11 powder coat finishes

EDGES | matching & coordinating finishes in the following options:

ABS 1: PVC-free impact resistant flat edge (S)

ABS 2: Multi-Ply "Plywood Look" flat vinyl edge (M)

ABS 3: Knife (KV), 1/2" Flat edge- bevel painted in a companion color

- Refer to edge code, above in (), when pricing below -

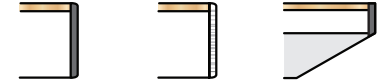

Standard Features:



- Adjustable leveling glides included.
- Power/Data options available, see Power/Data Solutions page.
- Wire management, grommets, etc. available, consult factory.

(*) = 2-Piece Top. (**) = 3-Piece Top Spline & Joint Fasteners included with table.

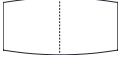

NOTE: Woodgrain pattern alignment between multiple tops not guaranteed.

SIZE	BASE INFO #, Style	MODEL #	ABS 1 S	ABS 2 M	ABS 3 KV	
WIDTH 42" HEIGHT 42"						
	42 x 72 x 42	(2) Y	SLXL427242BT	\$3,239	\$3,417	\$3,639
	42 x 84 x 42	(2) Y	SLXL428442BT	\$3,489	\$3,697	\$3,959
	42 x 96 x 42	(2) Y	SLXL429642BT	\$3,727	\$3,942	\$4,211

• For additional tables at 42" wide, use 48" wide sizes/pricing below- specify model # accordingly: (42" x 144" x 42" = SLXL4214442BT)

SIZE	BASE INFO #, Style	MODEL #	ABS 1 S	ABS 2 M	ABS 3 KV	
WIDTH 48" HEIGHT 42"						
	48 x 84 x 42	(2) Y	SLXL488442BT	\$3,899	\$4,105	\$4,362
	48 x 96 x 42	(2) Y	SLXL489642BT	\$4,073	\$4,297	\$4,578
	48 x 108 x 42	(2) Y	SLXL4810842BT	\$4,721	\$4,964	\$5,268
	* 48 x 120 x 42	(2) Y / (1) T	SLXL4812042BT	\$6,100	\$6,361	\$6,689
	* 48 x 144 x 42	(2) Y / (1) T	SLXL4814442BT	\$6,523	\$6,822	\$7,197
	* 48 x 156 x 42	(2) Y / (2) T	SLXL4815642BT	\$8,037	\$8,355	\$8,753
	* 48 x 168 x 42	(2) Y / (2) T	SLXL4816842BT	\$8,083	\$8,420	\$8,841
	* 48 x 180 x 42	(2) Y / (2) T	SLXL4818042BT	\$8,428	\$8,783	\$9,227
	** 48 x 192 x 42	(2) Y / (3) T	SLXL4819242BT	\$9,651	\$10,024	\$10,492
	** 48 x 204 x 42	(2) Y / (3) T	SLXL4820442BT	\$10,059	\$10,452	\$10,943
	** 48 x 216 x 42	(2) Y / (4) T	SLXL4821642BT	\$10,105	\$10,515	\$11,029
	** 48 x 228 x 42	(2) Y / (4) T	SLXL4822842BT	\$10,771	\$11,200	\$11,739
	** 48 x 240 x 42	(2) Y / (4) T	SLXL4824042BT	\$11,184	\$11,632	\$12,194

WIDTH 54" | HEIGHT 42" Use 60" wide sizes/pricing below- specify model # accordingly: (54" x 96" x 42" = SLXL549642BT)

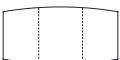
SIZE	BASE INFO #, Style	MODEL #	ABS 1 S	ABS 2 M	ABS 3 KV	
WIDTH 60" HEIGHT 42"						
	60 x 84 x 42	(2) Y	SLXL608442BT	\$4,366	\$4,590	\$4,990
	60 x 96 x 42	(2) Y	SLXL609642BT	\$4,647	\$4,890	\$5,324
	60 x 108 x 42	(2) Y	SLXL6010842BT	\$5,342	\$5,603	\$6,070
	* 60 x 120 x 42	(2) Y / (1) T	SLXL6012042BT	\$6,528	\$6,808	\$7,309
	* 60 x 144 x 42	(2) Y / (1) T	SLXL6014442BT	\$6,903	\$7,221	\$7,788
	* 60 x 156 x 42	(2) Y / (2) T	SLXL6015642BT	\$8,480	\$8,817	\$9,417
	* 60 x 168 x 42	(2) Y / (2) T	SLXL6016842BT	\$8,668	\$9,023	\$9,656
	* 60 x 180 x 42	(2) Y / (2) T	SLXL6018042BT	\$8,949	\$9,323	\$9,990
	** 60 x 192 x 42	(2) Y / (3) T	SLXL6019242BT	\$10,313	\$10,705	\$11,406
	** 60 x 204 x 42	(2) Y / (3) T	SLXL6020442BT	\$10,655	\$11,066	\$11,800
	** 60 x 216 x 42	(2) Y / (4) T	SLXL6021642BT	\$10,843	\$11,273	\$12,040
	** 60 x 228 x 42	(2) Y / (4) T	SLXL6022842BT	\$11,444	\$11,893	\$12,693
	** 60 x 240 x 42	(2) Y / (4) T	SLXL6024042BT	\$12,000	\$12,467	\$13,301

• To specify 36" high tables, use 42" high sizes/pricing above & adjust model # accordingly: (60" x 84" x 36" = SLXL608436BT)



HPL TOPS | 44 standard HPL finishes
METAL BASES | 11 powder coat finishes
EDGES | matching & coordinating finishes in the following options:

- ABS 1:** PVC-free impact resistant flat edge (S)
 - ABS 2:** Multi-Ply "Plywood Look" flat vinyl edge (M)
 - ABS 3:** Knife (KV), 1/2" Flat edge- bevel painted in a companion color
- Refer to edge code, above in (), when pricing below -

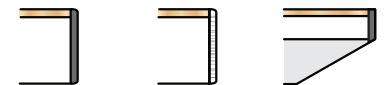



Standard Features:



- Adjustable leveling glides included.
- Power/Data options available, see Power/Data Solutions page.
- Wire management, grommets, etc. available, consult factory.
- (*) = 2-Piece Top. (**) = 3-Piece Top Spline & Joint Fasteners included with table.
- NOTE: Woodgrain pattern alignment between multiple tops not guaranteed.

SIZE	BASE INFO #, Style	MODEL #	ABS 1 S	ABS 2 M	ABS 3 KV	
WIDTH 42" HEIGHT 29"						
	42 x 72 x 29	(2) Y	SLXL4272DM	\$2,866	\$3,043	\$3,266
	42 x 84 x 29	(2) Y	SLXL4284DM	\$3,115	\$3,324	\$3,585
	42 x 96 x 29	(2) Y	SLXL4296DM	\$3,353	\$3,568	\$3,837

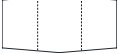
• For additional table sizes at 42" wide, use 48" wide sizes/pricing below- specify model # accordingly: (42" x 144" x 29" = SLXL42144DM)

SIZE	BASE INFO #, Style	MODEL #	ABS 1 S	ABS 2 M	ABS 3 KV	
WIDTH 48" HEIGHT 29"						
	48 x 84 x 29	(2) Y	SLXL4884DM	\$3,526	\$3,731	\$3,988
	48 x 96 x 29	(2) Y	SLXL4896DM	\$3,699	\$3,923	\$4,204
	48 x 108 x 29	(2) Y	SLXL48108DM	\$4,347	\$4,590	\$4,894
	* 48 x 120 x 29	(2) Y / (1) T	SLXL48120DM	\$5,539	\$5,801	\$6,128
	* 48 x 144 x 29	(2) Y / (1) T	SLXL48144DM	\$5,963	\$6,262	\$6,636
	* 48 x 156 x 29	(2) Y / (2) T	SLXL48156DM	\$7,290	\$7,607	\$8,005
	* 48 x 168 x 29	(2) Y / (2) T	SLXL48168DM	\$7,336	\$7,672	\$8,094
	* 48 x 180 x 29	(2) Y / (2) T	SLXL48180DM	\$7,680	\$8,035	\$8,480
	** 48 x 192 x 29	(2) Y / (3) T	SLXL48192DM	\$8,716	\$9,090	\$9,558
	** 48 x 204 x 29	(2) Y / (3) T	SLXL48204DM	\$9,125	\$9,517	\$10,009
	** 48 x 216 x 29	(2) Y / (4) T	SLXL48216DM	\$9,170	\$9,581	\$10,094
	** 48 x 228 x 29	(2) Y / (4) T	SLXL48228DM	\$9,836	\$10,266	\$10,804
	** 48 x 240 x 29	(2) Y / (4) T	SLXL48240DM	\$10,249	\$10,698	\$11,260

WIDTH 54" | HEIGHT 29" Use 60" wide sizes/pricing below- specify model # accordingly: (54" x 96" x 29" = SLXL5496DM)

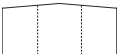
SIZE	BASE INFO #, Style	MODEL #	ABS 1 S	ABS 2 M	ABS 3 KV	
WIDTH 60" HEIGHT 29"						
	60 x 84 x 29	(2) Y	SLXL6084DM	\$3,992	\$4,216	\$4,616
	60 x 96 x 29	(2) Y	SLXL6096DM	\$4,273	\$4,516	\$4,950
	60 x 108 x 29	(2) Y	SLXL60108DM	\$4,968	\$5,230	\$5,696
	* 60 x 120 x 29	(2) Y / (1) T	SLXL60120DM	\$5,967	\$6,248	\$6,748
	* 60 x 144 x 29	(2) Y / (1) T	SLXL60144DM	\$6,342	\$6,660	\$7,227
	* 60 x 156 x 29	(2) Y / (2) T	SLXL60156DM	\$7,733	\$8,069	\$8,669
	* 60 x 168 x 29	(2) Y / (2) T	SLXL60168DM	\$7,920	\$8,275	\$8,909
	* 60 x 180 x 29	(2) Y / (2) T	SLXL60180DM	\$8,202	\$8,576	\$9,243
	** 60 x 192 x 29	(2) Y / (3) T	SLXL60192DM	\$9,378	\$9,771	\$10,471
	** 60 x 204 x 29	(2) Y / (3) T	SLXL60204DM	\$9,721	\$10,132	\$10,866
	** 60 x 216 x 29	(2) Y / (4) T	SLXL60216DM	\$9,908	\$10,338	\$11,105
	** 60 x 228 x 29	(2) Y / (4) T	SLXL60228DM	\$10,510	\$10,959	\$11,759
	** 60 x 240 x 29	(2) Y / (4) T	SLXL60240DM	\$11,065	\$11,533	\$12,366



HPL TOPS | 44 standard HPL finishes

METAL BASES | 11 powder coat finishes

EDGES | matching & coordinating finishes in the following options:

ABS 1: PVC-free impact resistant flat edge (S)

ABS 2: Multi-Ply "Plywood Look" flat vinyl edge (M)

ABS 3: Knife (KV), 1/2" Flat edge- bevel painted in a companion color

- Refer to edge code, above in (), when pricing below -

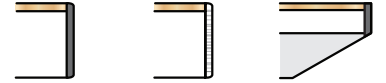

Standard Features:



- Adjustable leveling glides included.
- Power/Data options available, see Power/Data Solutions page.
- Wire management, grommets, etc. available, consult factory.

(*) = 2-Piece Top. (**) = 3-Piece Top Spline & Joint Fasteners included with table.



NOTE: Woodgrain pattern alignment between multiple tops not guaranteed.

SIZE	BASE INFO #, Style	MODEL #	ABS 1 S	ABS 2 M	ABS 3 KV	
WIDTH 42" HEIGHT 42"						
	42 x 72 x 42	(2) Y	SLXL427242DM	\$3,239	\$3,417	\$3,639
	42 x 84 x 42	(2) Y	SLXL428442DM	\$3,489	\$3,697	\$3,959
	42 x 96 x 42	(2) Y	SLXL429642DM	\$3,727	\$3,942	\$4,211

• For additional tables at 42" wide, use 48" wide sizes/pricing below- specify model # accordingly: (42" x 144" x 42" = SLXL4214442DM)

WIDTH 48" HEIGHT 42"						
	48 x 84 x 42	(2) Y	SLXL488442DM	\$3,899	\$4,105	\$4,362
	48 x 96 x 42	(2) Y	SLXL489642DM	\$4,073	\$4,297	\$4,578
	48 x 108 x 42	(2) Y	SLXL4810842DM	\$4,721	\$4,964	\$5,268
	* 48 x 120 x 42	(2) Y / (1) T	SLXL4812042DM	\$6,100	\$6,361	\$6,689
	* 48 x 144 x 42	(2) Y / (1) T	SLXL4814442DM	\$6,523	\$6,822	\$7,197
	* 48 x 156 x 42	(2) Y / (2) T	SLXL4815642DM	\$8,037	\$8,355	\$8,753
	* 48 x 168 x 42	(2) Y / (2) T	SLXL4816842DM	\$8,083	\$8,420	\$8,841
	* 48 x 180 x 42	(2) Y / (2) T	SLXL4818042DM	\$8,428	\$8,783	\$9,227
	** 48 x 192 x 42	(2) Y / (3) T	SLXL4819242DM	\$9,651	\$10,024	\$10,492
	** 48 x 204 x 42	(2) Y / (3) T	SLXL4820442DM	\$10,059	\$10,452	\$10,943
	** 48 x 216 x 42	(2) Y / (4) T	SLXL4821642DM	\$10,105	\$10,515	\$11,029
	** 48 x 228 x 42	(2) Y / (4) T	SLXL4822842DM	\$10,771	\$11,200	\$11,739
	** 48 x 240 x 42	(2) Y / (4) T	SLXL4824042DM	\$11,184	\$11,632	\$12,194

WIDTH 54" | HEIGHT 42" Use 60" wide sizes/pricing below- specify model # accordingly: (54" x 96" x 42" = SLXL549642DM)

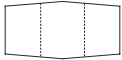
WIDTH 60" HEIGHT 42"						
	60 x 84 x 42	(2) Y	SLXL608442DM	\$4,366	\$4,590	\$4,990
	60 x 96 x 42	(2) Y	SLXL609642DM	\$4,647	\$4,890	\$5,324
	60 x 108 x 42	(2) Y	SLXL6010842DM	\$5,342	\$5,603	\$6,070
	* 60 x 120 x 42	(2) Y / (1) T	SLXL6012042DM	\$6,528	\$6,808	\$7,309
	* 60 x 144 x 42	(2) Y / (1) T	SLXL6014442DM	\$6,903	\$7,221	\$7,788
	* 60 x 156 x 42	(2) Y / (2) T	SLXL6015642DM	\$8,480	\$8,817	\$9,417
	* 60 x 168 x 42	(2) Y / (2) T	SLXL6016842DM	\$8,668	\$9,023	\$9,656
	* 60 x 180 x 42	(2) Y / (2) T	SLXL6018042DM	\$8,949	\$9,323	\$9,990
	** 60 x 192 x 42	(2) Y / (3) T	SLXL6019242DM	\$10,313	\$10,705	\$11,406
	** 60 x 204 x 42	(2) Y / (3) T	SLXL6020442DM	\$10,655	\$11,066	\$11,800
	** 60 x 216 x 42	(2) Y / (4) T	SLXL6021642DM	\$10,843	\$11,273	\$12,040
	** 60 x 228 x 42	(2) Y / (4) T	SLXL6022842DM	\$11,444	\$11,893	\$12,693
	** 60 x 240 x 42	(2) Y / (4) T	SLXL6024042DM	\$12,000	\$12,467	\$13,301

• To specify 36" high tables, use 42" high sizes/pricing above & adjust model # accordingly: (60" x 84" x 36" = SLXL608436DM)

SLALOM XL | BOW END | HEIGHT: 29"



HPL TOPS | 44 standard HPL finishes

METAL BASES | 11 powder coat finishes

EDGES | matching & coordinating finishes in the following options:

ABS 1: PVC-free impact resistant flat edge (S)

ABS 2: Multi-Ply "Plywood Look" flat vinyl edge (M)

ABS 3: Knife (KV), 1/2" Flat edge- bevel painted in a companion color

- Refer to edge code, above in (), when pricing below -

Standard Features:

- Adjustable leveling glides included.
- Power/Data options available, see Power/Data Solutions page.
- Wire management, grommets, etc. available, consult factory.

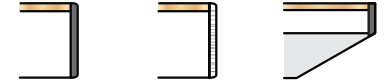

(*) = 2-Piece Top. (**) = 3-Piece Top Spline & Joint Fasteners included with table.

NOTE: Woodgrain pattern alignment between multiple tops not guaranteed.





SIZE	BASE INFO #, Style	MODEL #	ABS 1 S	ABS 2 M	ABS 3 KV	
WIDTH 42" HEIGHT 29"						
	42 x 72 x 29	(2) Y	SLXL4272BE	\$2,866	\$3,043	\$3,266
	42 x 84 x 29	(2) Y	SLXL4284BE	\$3,115	\$3,324	\$3,585
	42 x 96 x 29	(2) Y	SLXL4296BE	\$3,353	\$3,568	\$3,837

• For additional table sizes at 42" wide, use 48" wide sizes/pricing below- specify model # accordingly: (42" x 144" x 29" = SLXL42144BE)

SIZE	BASE INFO #, Style	MODEL #	ABS 1 S	ABS 2 M	ABS 3 KV	
WIDTH 48" HEIGHT 29"						
	48 x 84 x 29	(2) Y	SLXL4884BE	\$3,526	\$3,731	\$3,988
	48 x 96 x 29	(2) Y	SLXL4896BE	\$3,699	\$3,923	\$4,204
	48 x 108 x 29	(2) Y	SLXL48108BE	\$4,347	\$4,590	\$4,894
	* 48 x 120 x 29	(2) Y / (1) T	SLXL48120BE	\$5,539	\$5,801	\$6,128
	* 48 x 144 x 29	(2) Y / (1) T	SLXL48144BE	\$5,963	\$6,262	\$6,636
	* 48 x 156 x 29	(2) Y / (2) T	SLXL48156BE	\$7,290	\$7,607	\$8,005
	* 48 x 168 x 29	(2) Y / (2) T	SLXL48168BE	\$7,336	\$7,672	\$8,094
	* 48 x 180 x 29	(2) Y / (2) T	SLXL48180BE	\$7,680	\$8,035	\$8,480
	** 48 x 192 x 29	(2) Y / (3) T	SLXL48192BE	\$8,716	\$9,090	\$9,558
	** 48 x 204 x 29	(2) Y / (3) T	SLXL48204BE	\$9,125	\$9,517	\$10,009
	** 48 x 216 x 29	(2) Y / (4) T	SLXL48216BE	\$9,170	\$9,581	\$10,094
	** 48 x 228 x 29	(2) Y / (4) T	SLXL48228BE	\$9,836	\$10,266	\$10,804
	** 48 x 240 x 29	(2) Y / (4) T	SLXL48240BE	\$10,249	\$10,698	\$11,260

WIDTH 54" | HEIGHT 29" Use 60" wide sizes/pricing below- specify model # accordingly: (54" x 96" x 29" = SLXL549642BE)

SIZE	BASE INFO #, Style	MODEL #	ABS 1 S	ABS 2 M	ABS 3 KV	
WIDTH 60" HEIGHT 29"						
	60 x 84 x 29	(2) Y	SLXL6084BE	\$3,992	\$4,216	\$4,616
	60 x 96 x 29	(2) Y	SLXL6096BE	\$4,273	\$4,516	\$4,950
	60 x 108 x 29	(2) Y	SLXL60108BE	\$4,968	\$5,230	\$5,696
	* 60 x 120 x 29	(2) Y / (1) T	SLXL60120BE	\$5,967	\$6,248	\$6,748
	* 60 x 144 x 29	(2) Y / (1) T	SLXL60144BE	\$6,342	\$6,660	\$7,227
	* 60 x 156 x 29	(2) Y / (2) T	SLXL60156BE	\$7,733	\$8,069	\$8,669
	* 60 x 168 x 29	(2) Y / (2) T	SLXL60168BE	\$7,920	\$8,275	\$8,909
	* 60 x 180 x 29	(2) Y / (2) T	SLXL60180BE	\$8,202	\$8,576	\$9,243
	** 60 x 192 x 29	(2) Y / (3) T	SLXL60192BE	\$9,378	\$9,771	\$10,471
	** 60 x 204 x 29	(2) Y / (3) T	SLXL60204BE	\$9,721	\$10,132	\$10,866
	** 60 x 216 x 29	(2) Y / (4) T	SLXL60216BE	\$9,908	\$10,338	\$11,105
	** 60 x 228 x 29	(2) Y / (4) T	SLXL60228BE	\$10,510	\$10,959	\$11,759
	** 60 x 240 x 29	(2) Y / (4) T	SLXL60240BE	\$11,065	\$11,533	\$12,366

SLALOM XL | BOW END

HEIGHT: 42", FOR 36" SEE NOTE AT BOTTOM OF PAGE



HPL TOPS | 44 standard HPL finishes

METAL BASES | 11 powder coat finishes

EDGES | matching & coordinating finishes in the following options:

ABS 1: PVC-free impact resistant flat edge (S)

ABS 2: Multi-Ply "Plywood Look" flat vinyl edge (M)

ABS 3: Knife (KV), 1/2" Flat edge- bevel painted in a companion color

- Refer to edge code, above in (), when pricing below -

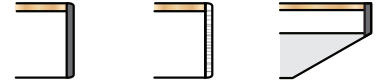

Standard Features:

- Adjustable leveling glides included.
- Power/Data options available, see Power/Data Solutions page.
- Wire management, grommets, etc. available, consult factory.



(*) = 2-Piece Top. (**) = 3-Piece Top Spline & Joint Fasteners included with table.

NOTE: Woodgrain pattern alignment between multiple tops not guaranteed.

SIZE	BASE INFO #, Style	MODEL #	ABS 1 S	ABS 2 M	ABS 3 KV	
WIDTH 42" HEIGHT 42"						
	42 x 72 x 42	(2) Y	SLXL427242BE	\$3,239	\$3,417	\$3,639
	42 x 84 x 42	(2) Y	SLXL428442BE	\$3,489	\$3,697	\$3,959
	42 x 96 x 42	(2) Y	SLXL429642BE	\$3,727	\$3,942	\$4,211

• For additional tables at 42" wide, use 48" wide sizes/pricing below- specify model # accordingly: (42" x 144" x 42" = SLXL4214442BE)



WIDTH 48" | HEIGHT 42"

	48 x 84 x 42	(2) Y	SLXL488442BE	\$3,899	\$4,105	\$4,362
	48 x 96 x 42	(2) Y	SLXL489642BE	\$4,073	\$4,297	\$4,578
	48 x 108 x 42	(2) Y	SLXL4810842BE	\$4,721	\$4,964	\$5,268
	* 48 x 120 x 42	(2) Y / (1) T	SLXL4812042BE	\$6,100	\$6,361	\$6,689
	* 48 x 144 x 42	(2) Y / (1) T	SLXL4814442BE	\$6,523	\$6,822	\$7,197
	* 48 x 156 x 42	(2) Y / (2) T	SLXL4815642BE	\$8,037	\$8,355	\$8,753
	* 48 x 168 x 42	(2) Y / (2) T	SLXL4816842BE	\$8,083	\$8,420	\$8,841
	* 48 x 180 x 42	(2) Y / (2) T	SLXL4818042BE	\$8,428	\$8,783	\$9,227
	** 48 x 192 x 42	(2) Y / (3) T	SLXL4819242BE	\$9,651	\$10,024	\$10,492
	** 48 x 204 x 42	(2) Y / (3) T	SLXL4820442BE	\$10,059	\$10,452	\$10,943
	** 48 x 216 x 42	(2) Y / (4) T	SLXL4821642BE	\$10,105	\$10,515	\$11,029
	** 48 x 228 x 42	(2) Y / (4) T	SLXL4822842BE	\$10,771	\$11,200	\$11,739
	** 48 x 240 x 42	(2) Y / (4) T	SLXL4824042BE	\$11,184	\$11,632	\$12,194

WIDTH 54" | HEIGHT 42"

Use 60" wide sizes/pricing below- specify model # accordingly: (54" x 96" x 42" = SLXL549642BE)

WIDTH 60" | HEIGHT 42"

	60 x 84 x 42	(2) Y	SLXL608442BE	\$4,366	\$4,590	\$4,990
	60 x 96 x 42	(2) Y	SLXL609642BE	\$4,647	\$4,890	\$5,324
	60 x 108 x 42	(2) Y	SLXL6010842BE	\$5,342	\$5,603	\$6,070
	* 60 x 120 x 42	(2) Y / (1) T	SLXL6012042BE	\$6,528	\$6,808	\$7,309
	* 60 x 144 x 42	(2) Y / (1) T	SLXL6014442BE	\$6,903	\$7,221	\$7,788
	* 60 x 156 x 42	(2) Y / (2) T	SLXL6015642BE	\$8,480	\$8,817	\$9,417
	* 60 x 168 x 42	(2) Y / (2) T	SLXL6016842BE	\$8,668	\$9,023	\$9,656
	* 60 x 180 x 42	(2) Y / (2) T	SLXL6018042BE	\$8,949	\$9,323	\$9,990
	** 60 x 192 x 42	(2) Y / (3) T	SLXL6019242BE	\$10,313	\$10,705	\$11,406
	** 60 x 204 x 42	(2) Y / (3) T	SLXL6020442BE	\$10,655	\$11,066	\$11,800
	** 60 x 216 x 42	(2) Y / (4) T	SLXL6021642BE	\$10,843	\$11,273	\$12,040
	** 60 x 228 x 42	(2) Y / (4) T	SLXL6022842BE	\$11,444	\$11,893	\$12,693
	** 60 x 240 x 42	(2) Y / (4) T	SLXL6024042BE	\$12,000	\$12,467	\$13,301

• To specify 36" high tables, use 42" high sizes/pricing above & adjust model # accordingly: (60" x 84" x 36" = SLXL608436SBE)



HPL TOPS | 44 standard HPL finishes

METAL BASES | 11 powder coat finishes

EDGES | matching & coordinating finishes in the following options:

ABS 1: PVC-free impact resistant flat edge (S)

ABS 2: Multi-Ply "Plywood Look" flat vinyl edge (M)

ABS 3: Knife (KV), 1/2" Flat edge- bevel painted in a companion color

- Refer to edge code, above in (), when pricing below -



Standard Features:

- Adjustable leveling glides included.
- Power/Data options available, see Power/Data Solutions page.
- Wire management, grommets, etc. available, consult factory.

(*) = 2-Piece Top. (**) = 3-Piece Top Spline & Joint Fasteners included with table.

NOTE: Woodgrain pattern alignment between multiple tops not guaranteed.

SIZE	BASE INFO #, Style	MODEL #	ABS 1 S	ABS 2 M	ABS 3 KV	
WIDTH 42" HEIGHT 29"						
	42 x 72 x 29	(2) Y	SLXL4284OV	\$2,866	\$3,043	\$3,266
	42 x 84 x 29	(2) Y	SLXL4284OV	\$3,115	\$3,324	\$3,585
	42 x 96 x 29	(2) Y	SLXL4296OV	\$3,353	\$3,568	\$3,837
• For additional table sizes at 42" wide, use 48" wide sizes/pricing below- specify model # accordingly: (42" x 144" x 29" = SLXL42144OV)						
WIDTH 48" HEIGHT 29"						
	48 x 84 x 29	(2) Y	SLXL4884OV	\$3,526	\$3,731	\$3,988
	48 x 96 x 29	(2) Y	SLXL4896OV	\$3,699	\$3,923	\$4,204
	48 x 108 x 29	(2) Y	SLXL48108OV	\$4,347	\$4,590	\$4,894
	* 48 x 120 x 29	(2) Y	SLXL48120OV	\$5,539	\$5,801	\$6,128
	* 48 x 144 x 29	(2) Y / (1) T	SLXL48144OV	\$5,963	\$6,262	\$6,636
WIDTH 54" HEIGHT 29" : Use 60" wide sizes/pricing below- specify model # accordingly: (54" x 96" x 29" = SLXL5496OV)						
WIDTH 60" HEIGHT 29"						
	60 x 84 x 29	(2) Y	SLXL6084OV	\$3,992	\$4,216	\$4,616
	60 x 96 x 29	(2) Y	SLXL6096OV	\$4,273	\$4,516	\$4,950
	60 x 108 x 29	(2) Y	SLXL60108OV	\$4,968	\$5,230	\$5,696
	* 60 x 120 x 29	(2) Y	SLXL60120OV	\$5,967	\$6,248	\$6,748
	* 60 x 144 x 29	(2) Y / (1) T	SLXL60144OV	\$6,342	\$6,660	\$7,227
WIDTH 42" HEIGHT 42"						
	42 x 72 x 42	(2) Y	SLXL428442OV	\$3,239	\$3,417	\$3,639
	42 x 84 x 42	(2) Y	SLXL428442OV	\$3,489	\$3,697	\$3,959
	42 x 96 x 42	(2) Y	SLXL429642OV	\$3,727	\$3,942	\$4,211
• For additional table sizes at 42" wide, use 48" wide sizes/pricing below- specify model # accordingly: (42" x 108" x 42" = SLXL4210842OV)						
WIDTH 48" HEIGHT 42"						
	48 x 84 x 42	(2) Y	SLXL488442OV	\$3,899	\$4,105	\$4,362
	48 x 96 x 42	(2) Y	SLXL489642OV	\$4,073	\$4,297	\$4,578
	48 x 108 x 42	(2) Y	SLXL4810842OV	\$4,721	\$4,964	\$5,268
	* 48 x 120 x 42	(2) Y	SLXL4812042OV	\$6,100	\$6,361	\$6,689
	* 48 x 144 x 42	(2) Y / (1) T	SLXL4814442OV	\$6,523	\$6,822	\$7,197
WIDTH 54" HEIGHT 42" : Use 60" wide sizes/pricing below- specify model # accordingly: (54" x 96" x 42" = SLXL549642OV)						
WIDTH 60" HEIGHT 42"						
	60 x 84 x 42	(2) Y	SLXL608442OV	\$4,366	\$4,590	\$4,990
	60 x 96 x 42	(2) Y	SLXL609642OV	\$4,647	\$4,890	\$5,324
	60 x 108 x 42	(2) Y	SLXL6010842OV	\$5,342	\$5,603	\$6,070
	* 60 x 120 x 42	(2) Y	SLXL6012042OV	\$6,528	\$6,808	\$7,309
	* 60 x 144 x 42	(2) Y / (1) T	SLXL6014442OV	\$6,903	\$7,221	\$7,788

• To specify 36" high tables, use 42" high sizes/pricing above & adjust model # accordingly: (60" x 84" x 36" = SLXL608436OV)



HPL TOPS | 44 standard HPL finishes

METAL BASES | 11 powder coat finishes

EDGES | matching & coordinating finishes in the following options:

ABS 1: PVC-free impact resistant flat edge (S)

ABS 2: Multi-Ply "Plywood Look" flat vinyl edge (M)

ABS 3: Knife (KV), 1/2" Flat edge- bevel painted in a companion color

- Refer to edge code, above in (), when pricing below -

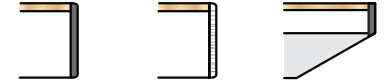

Standard Features:

- Adjustable leveling glides included.
- Power/Data options available, see Power/Data Solutions page.
- Wire management, grommets, etc. available, consult factory.

(*) = 2-Piece Top. (**) = 3-Piece Top Spline & Joint Fasteners included with table.

NOTE: Woodgrain pattern alignment between multiple tops not guaranteed.

SIZE	BASE INFO #, Style	MODEL #	ABS 1 S	ABS 2 M	ABS 3 KV	
WIDTH 42" HEIGHT 29"						
	42 x 72 x 29	(2) Y	SLXL4272RT	\$2,866	\$3,043	\$3,266
	42 x 84 x 29	(2) Y	SLXL4284RT	\$3,115	\$3,324	\$3,585
	42 x 96 x 29	(2) Y	SLXL4296RT	\$3,353	\$3,568	\$3,837

• For additional table sizes at 42" wide, use 48" wide sizes/pricing below- specify model # accordingly: (42" x 144" x 29" = SLXL42144RT)

SIZE	BASE INFO #, Style	MODEL #	ABS 1 S	ABS 2 M	ABS 3 KV	
WIDTH 48" HEIGHT 29"						
	48 x 84 x 29	(2) Y	SLXL4884RT	\$3,526	\$3,731	\$3,988
	48 x 96 x 29	(2) Y	SLXL4896RT	\$3,699	\$3,923	\$4,204
	48 x 108 x 29	(2) Y	SLXL48108RT	\$4,347	\$4,590	\$4,894
	* 48 x 120 x 29	(2) Y / (1) T	SLXL48120RT	\$5,539	\$5,801	\$6,128
	* 48 x 144 x 29	(2) Y / (1) T	SLXL48144RT	\$5,963	\$6,262	\$6,636
	* 48 x 156 x 29	(2) Y / (2) T	SLXL48156RT	\$7,290	\$7,607	\$8,005
	* 48 x 168 x 29	(2) Y / (2) T	SLXL48168RT	\$7,336	\$7,672	\$8,094
	* 48 x 180 x 29	(2) Y / (2) T	SLXL48180RT	\$7,680	\$8,035	\$8,480
	** 48 x 192 x 29	(2) Y / (3) T	SLXL48192RT	\$8,716	\$9,090	\$9,558
	** 48 x 204 x 29	(2) Y / (3) T	SLXL48204RT	\$9,125	\$9,517	\$10,009
	** 48 x 216 x 29	(2) Y / (4) T	SLXL48216RT	\$9,170	\$9,581	\$10,094
	** 48 x 228 x 29	(2) Y / (4) T	SLXL48228RT	\$9,836	\$10,266	\$10,804
** 48 x 240 x 29	(2) Y / (4) T	SLXL48240RT	\$10,249	\$10,698	\$11,260	

WIDTH 54" | HEIGHT 29" Use 60" wide sizes/pricing below- specify model # accordingly: (54" x 96" x 29" = SLXL5496RT)

SIZE	BASE INFO #, Style	MODEL #	ABS 1 S	ABS 2 M	ABS 3 KV	
WIDTH 60" HEIGHT 29"						
	60 x 84 x 29	(2) Y	SLXL6084RT	\$3,992	\$4,216	\$4,616
	60 x 96 x 29	(2) Y	SLXL6096RT	\$4,273	\$4,516	\$4,950
	60 x 108 x 29	(2) Y	SLXL60108RT	\$4,968	\$5,230	\$5,696
	* 60 x 120 x 29	(2) Y / (1) T	SLXL60120RT	\$5,967	\$6,248	\$6,748
	* 60 x 144 x 29	(2) Y / (1) T	SLXL60144RT	\$6,342	\$6,660	\$7,227
	* 60 x 156 x 29	(2) Y / (2) T	SLXL60156RT	\$7,733	\$8,069	\$8,669
	* 60 x 168 x 29	(2) Y / (2) T	SLXL60168RT	\$7,920	\$8,275	\$8,909
	* 60 x 180 x 29	(2) Y / (2) T	SLXL60180RT	\$8,202	\$8,576	\$9,243
	** 60 x 192 x 29	(2) Y / (3) T	SLXL60192RT	\$9,378	\$9,771	\$10,471
	** 60 x 204 x 29	(2) Y / (3) T	SLXL60204RT	\$9,721	\$10,132	\$10,866
	** 60 x 216 x 29	(2) Y / (4) T	SLXL60216RT	\$9,908	\$10,338	\$11,105
	** 60 x 228 x 29	(2) Y / (4) T	SLXL60228RT	\$10,510	\$10,959	\$11,759
** 60 x 240 x 29	(2) Y / (4) T	SLXL60240RT	\$11,065	\$11,533	\$12,366	



HPL TOPS | 44 standard HPL finishes

METAL BASES | 11 powder coat finishes

EDGES | matching & coordinating finishes in the following options:

ABS 1: PVC-free impact resistant flat edge (S)

ABS 2: Multi-Ply "Plywood Look" flat vinyl edge (M)

ABS 3: Knife (KV), 1/2" Flat edge- bevel painted in a companion color

- Refer to edge code, above in (), when pricing below -

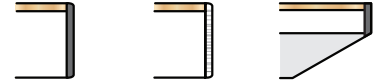

Standard Features:

- Adjustable leveling glides included.
- Power/Data options available, see Power/Data Solutions page.
- Wire management, grommets, etc. available, consult factory.

(*) = 2-Piece Top. (**) = 3-Piece Top Spline & Joint Fasteners included with table.

NOTE: Woodgrain pattern alignment between multiple tops not guaranteed.

SIZE	BASE INFO #, Style	MODEL #	ABS 1 S	ABS 2 M	ABS 3 KV	
WIDTH 42" HEIGHT 42"						
	42 x 72 x 42	(2) Y	SLXL427242RT	\$3,239	\$3,417	\$3,639
	42 x 84 x 42	(2) Y	SLXL428442RT	\$3,489	\$3,697	\$3,959
	42 x 96 x 42	(2) Y	SLXL429642RT	\$3,727	\$3,942	\$4,211

• For additional tables at 42" wide, use 48" wide sizes/pricing below- specify model # accordingly: (42" x 144" x 29" = SLXL42144RT)

WIDTH 48" HEIGHT 42"						
	48 x 84 x 42	(2) Y	SLXL488442RT	\$3,899	\$4,105	\$4,362
	48 x 96 x 42	(2) Y	SLXL489642RT	\$4,073	\$4,297	\$4,578
	48 x 108 x 42	(2) Y	SLXL4810842RT	\$4,721	\$4,964	\$5,268
	* 48 x 120 x 42	(2) Y / (1) T	SLXL4812042RT	\$6,100	\$6,361	\$6,689
	* 48 x 144 x 42	(2) Y / (1) T	SLXL4814442RT	\$6,523	\$6,822	\$7,197
	* 48 x 156 x 42	(2) Y / (2) T	SLXL4815642RT	\$8,037	\$8,355	\$8,753
	* 48 x 168 x 42	(2) Y / (2) T	SLXL4816842RT	\$8,083	\$8,420	\$8,841
	* 48 x 180 x 42	(2) Y / (2) T	SLXL4818042RT	\$8,428	\$8,783	\$9,227
	** 48 x 192 x 42	(2) Y / (3) T	SLXL4819242RT	\$9,651	\$10,024	\$10,492
	** 48 x 204 x 42	(2) Y / (3) T	SLXL4820442RT	\$10,059	\$10,452	\$10,943
	** 48 x 216 x 42	(2) Y / (4) T	SLXL4821642RT	\$10,105	\$10,515	\$11,029
	** 48 x 228 x 42	(2) Y / (4) T	SLXL4822842RT	\$10,771	\$11,200	\$11,739
	** 48 x 240 x 42	(2) Y / (4) T	SLXL4824042RT	\$11,184	\$11,632	\$12,194

WIDTH 54" | HEIGHT 42" Use 60" wide sizes/pricing below- specify model # accordingly: (54" x 96" x 42" = SLXL549642RT)

WIDTH 60" HEIGHT 42"						
	60 x 84 x 42	(2) Y	SLXL608442RT	\$4,366	\$4,590	\$4,990
	60 x 96 x 42	(2) Y	SLXL609642RT	\$4,647	\$4,890	\$5,324
	60 x 108 x 42	(2) Y	SLXL6010842RT	\$5,342	\$5,603	\$6,070
	* 60 x 120 x 42	(2) Y / (1) T	SLXL6012042RT	\$6,528	\$6,808	\$7,309
	* 60 x 144 x 42	(2) Y / (1) T	SLXL6014442RT	\$6,903	\$7,221	\$7,788
	* 60 x 156 x 42	(2) Y / (2) T	SLXL6015642RT	\$8,480	\$8,817	\$9,417
	* 60 x 168 x 42	(2) Y / (2) T	SLXL6016842RT	\$8,668	\$9,023	\$9,656
	* 60 x 180 x 42	(2) Y / (2) T	SLXL6018042RT	\$8,949	\$9,323	\$9,990
	** 60 x 192 x 42	(2) Y / (3) T	SLXL6019242RT	\$10,313	\$10,705	\$11,406
	** 60 x 204 x 42	(2) Y / (3) T	SLXL6020442RT	\$10,655	\$11,066	\$11,800
	** 60 x 216 x 42	(2) Y / (4) T	SLXL6021642RT	\$10,843	\$11,273	\$12,040
	** 60 x 228 x 42	(2) Y / (4) T	SLXL6022842RT	\$11,444	\$11,893	\$12,693
	** 60 x 240 x 42	(2) Y / (4) T	SLXL6024042RT	\$12,000	\$12,467	\$13,301

• To specify 36" high tables, use 42" high sizes/pricing above & adjust model # accordingly: (60" x 84" x 36" = SLXL608436RT)



HPL TOPS | 44 standard HPL finishes

METAL BASES | 11 powder coat finishes

EDGES | matching & coordinating finishes in the following options:

ABS 1: PVC-free impact resistant flat edge (S)

ABS 2: Multi-Ply "Plywood Look" flat vinyl edge (M)

ABS 3: Knife (KV), 1/2" Flat edge- bevel painted in a companion color

- Refer to edge code, above in (), when pricing below -

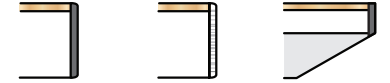

Standard Features:



- Adjustable leveling glides included.
- Power/Data options available, see Power/Data Solutions page.
- Wire management, grommets, etc. available, consult factory.

(*) = 2-Piece Top. (**) = 3-Piece Top Spline & Joint Fasteners included with table.



NOTE: Woodgrain pattern alignment between multiple tops not guaranteed.

SIZE	BASE INFO #, Style	MODEL #	ABS 1 S	ABS 2 M	ABS 3 KV	
WIDTH 42" HEIGHT 29"						
	42 72 x 29	(2) Y	SLXL4272BR	\$2,866	\$3,043	\$3,266
	42 x 84 x 29	(2) Y	SLXL4284BR	\$3,115	\$3,324	\$3,585
	42 x 96 x 29	(2) Y	SLXL4296BR	\$3,353	\$3,568	\$3,837

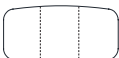
• For additional table sizes at 42" wide, use 48" wide sizes/pricing below- specify model # accordingly: (42" x 144" x 29" = SLXL42144BR)

WIDTH 48" HEIGHT 29"						
	48 x 84 x 29	(2) Y	SLXL4884BR	\$3,526	\$3,731	\$3,988
	48 x 96 x 29	(2) Y	SLXL4896BR	\$3,699	\$3,923	\$4,204
	48 x 108 x 29	(2) Y	SLXL48108BR	\$4,347	\$4,590	\$4,894
	* 48 x 120 x 29	(2) Y / (1) T	SLXL48120BR	\$5,539	\$5,801	\$6,128
	* 48 x 144 x 29	(2) Y / (1) T	SLXL48144BR	\$5,963	\$6,262	\$6,636
	* 48 x 156 x 29	(2) Y / (2) T	SLXL48156BR	\$7,290	\$7,607	\$8,005
	* 48 x 168 x 29	(2) Y / (2) T	SLXL48168BR	\$7,336	\$7,672	\$8,094
	* 48 x 180 x 29	(2) Y / (2) T	SLXL48180BR	\$7,680	\$8,035	\$8,480
	** 48 x 192 x 29	(2) Y / (3) T	SLXL48192BR	\$8,716	\$9,090	\$9,558
	** 48 x 204 x 29	(2) Y / (3) T	SLXL48204BR	\$9,125	\$9,517	\$10,009
	** 48 x 216 x 29	(2) Y / (4) T	SLXL48216BR	\$9,170	\$9,581	\$10,094
	** 48 x 228 x 29	(2) Y / (4) T	SLXL48228BR	\$9,836	\$10,266	\$10,804
	** 48 x 240 x 29	(2) Y / (4) T	SLXL48240BR	\$10,249	\$10,698	\$11,260

WIDTH 54" | HEIGHT 29" Use 60" wide sizes/pricing below- specify model # accordingly: (54" x 96" x 29" = SLXL5496BR)

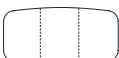
WIDTH 60" HEIGHT 29"						
	60 x 84 x 29	(2) Y	SLXL6084BR	\$3,992	\$4,216	\$4,616
	60 x 96 x 29	(2) Y	SLXL6096BR	\$4,273	\$4,516	\$4,950
	60 x 108 x 29	(2) Y	SLXL60108BR	\$4,968	\$5,230	\$5,696
	* 60 x 120 x 29	(2) Y / (1) T	SLXL60120BR	\$5,967	\$6,248	\$6,748
	* 60 x 144 x 29	(2) Y / (1) T	SLXL60144BR	\$6,342	\$6,660	\$7,227
	* 60 x 156 x 29	(2) Y / (2) T	SLXL60156BR	\$7,733	\$8,069	\$8,669
	* 60 x 168 x 29	(2) Y / (2) T	SLXL60168BR	\$7,920	\$8,275	\$8,909
	* 60 x 180 x 29	(2) Y / (2) T	SLXL60180BR	\$8,202	\$8,576	\$9,243
	** 60 x 192 x 29	(2) Y / (3) T	SLXL60192BR	\$9,378	\$9,771	\$10,471
	** 60 x 204 x 29	(2) Y / (3) T	SLXL60204BR	\$9,721	\$10,132	\$10,866
	** 60 x 216 x 29	(2) Y / (4) T	SLXL60216BR	\$9,908	\$10,338	\$11,105
	** 60 x 228 x 29	(2) Y / (4) T	SLXL60228BR	\$10,510	\$10,959	\$11,759
	** 60 x 240 x 29	(2) Y / (4) T	SLXL60240BR	\$11,065	\$11,533	\$12,366



HPL TOPS | 44 standard HPL finishes

METAL BASES | 11 powder coat finishes

EDGES | matching & coordinating finishes in the following options:

ABS 1: PVC-free impact resistant flat edge (S)

ABS 2: Multi-Ply "Plywood Look" flat vinyl edge (M)

ABS 3: Knife (KV), 1/2" Flat edge- bevel painted in a companion color

- Refer to edge code, above in (), when pricing below -

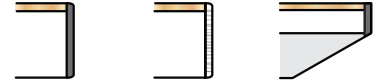

Standard Features:

- Adjustable leveling glides included.
- Power/Data options available, see Power/Data Solutions page.
- Wire management, grommets, etc. available, consult factory.

(*) = 2-Piece Top. (**) = 3-Piece Top Spline & Joint Fasteners included with table.

NOTE: Woodgrain pattern alignment between multiple tops not guaranteed.

SIZE	BASE INFO #, Style	MODEL #	ABS 1 S	ABS 2 M	ABS 3 KV	
WIDTH 42" HEIGHT 42"						
	42 x 72 x 42	(2) Y	SLXL427242BR	\$3,239	\$3,417	\$3,639
	42 x 84 x 42	(2) Y	SLXL428442BR	\$3,489	\$3,697	\$3,959
	42 x 96 x 42	(2) Y	SLXL429642BR	\$3,727	\$3,942	\$4,211

• For additional tables at 42" wide, use 48" wide sizes/pricing below- specify model # accordingly: (42" x 144" x 42" = SLXL4214442BR)

WIDTH 48" HEIGHT 42"						
	48 x 84 x 42	(2) Y	SLXL488442BR	\$3,899	\$4,105	\$4,362
	48 x 96 x 42	(2) Y	SLXL489642BR	\$4,073	\$4,297	\$4,578
	48 x 108 x 42	(2) Y	SLXL4810842BR	\$4,721	\$4,964	\$5,268
	* 48 x 120 x 42	(2) Y / (1) T	SLXL4812042BR	\$6,100	\$6,361	\$6,689
	* 48 x 144 x 42	(2) Y / (1) T	SLXL4814442BR	\$6,523	\$6,822	\$7,197
	* 48 x 156 x 42	(2) Y / (2) T	SLXL4815642BR	\$8,037	\$8,355	\$8,753
	* 48 x 168 x 42	(2) Y / (2) T	SLXL4816842BR	\$8,083	\$8,420	\$8,841
	* 48 x 180 x 42	(2) Y / (2) T	SLXL4818042BR	\$8,428	\$8,783	\$9,227
	** 48 x 192 x 42	(2) Y / (3) T	SLXL4819242BR	\$9,651	\$10,024	\$10,492
	** 48 x 204 x 42	(2) Y / (3) T	SLXL4820442BR	\$10,059	\$10,452	\$10,943
	** 48 x 216 x 42	(2) Y / (4) T	SLXL4821642BR	\$10,105	\$10,515	\$11,029
	** 48 x 228 x 42	(2) Y / (4) T	SLXL4822842BR	\$10,771	\$11,200	\$11,739
	** 48 x 240 x 42	(2) Y / (4) T	SLXL4824042BR	\$11,184	\$11,632	\$12,194

WIDTH 54" | HEIGHT 42" Use 60" wide sizes/pricing below- specify model # accordingly: (54" x 96" x 42" = SLXL549642BR)

WIDTH 60" HEIGHT 42"						
	60 x 84 x 42	(2) Y	SLXL608442BR	\$4,366	\$4,590	\$4,990
	60 x 96 x 42	(2) Y	SLXL609642BR	\$4,647	\$4,890	\$5,324
	60 x 108 x 42	(2) Y	SLXL6010842BR	\$5,342	\$5,603	\$6,070
	* 60 x 120 x 42	(2) Y / (1) T	SLXL6012042BR	\$6,528	\$6,808	\$7,309
	* 60 x 144 x 42	(2) Y / (1) T	SLXL6014442BR	\$6,903	\$7,221	\$7,788
	* 60 x 156 x 42	(2) Y / (2) T	SLXL6015642BR	\$8,480	\$8,817	\$9,417
	* 60 x 168 x 42	(2) Y / (2) T	SLXL6016842BR	\$8,668	\$9,023	\$9,656
	* 60 x 180 x 42	(2) Y / (2) T	SLXL6018042BR	\$8,949	\$9,323	\$9,990
	** 60 x 192 x 42	(2) Y / (3) T	SLXL6019242BR	\$10,313	\$10,705	\$11,406
	** 60 x 204 x 42	(2) Y / (3) T	SLXL6020442BR	\$10,655	\$11,066	\$11,800
	** 60 x 216 x 42	(2) Y / (4) T	SLXL6021642BR	\$10,843	\$11,273	\$12,040
	** 60 x 228 x 42	(2) Y / (4) T	SLXL6022842BR	\$11,444	\$11,893	\$12,693
	** 60 x 240 x 42	(2) Y / (4) T	SLXL6024042BR	\$12,000	\$12,467	\$13,301

• To specify 36" high tables, use 42" high sizes/pricing above & adjust model # accordingly: (60" x 84" x 36" = SLXL608436BR)



HPL TOPS | 44 standard HPL finishes

METAL BASES | 11 powder coat finishes

EDGES | matching & coordinating finishes in the following options:

ABS 1: PVC-free impact resistant flat edge (S)

ABS 2: Multi-Ply "Plywood Look" flat vinyl edge (M)

ABS 3: Knife (KV), 1/2" Flat edge- bevel painted in a companion color

- Refer to edge code, above in (), when pricing below -

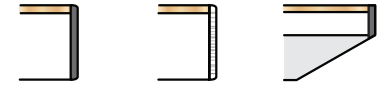

Standard Features:



- Adjustable leveling glides included.
- Power/Data options available, see Power/Data Solutions page.
- Wire management, grommets, etc. available, consult factory.

(*) = 2-Piece Top. (**) = 3-Piece Top Spline & Joint Fasteners included with table.

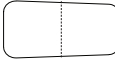

NOTE: Woodgrain pattern alignment between multiple tops not guaranteed.

SIZE	BASE INFO #, Style	MODEL #	ABS 1 S	ABS 2 M	ABS 3 KV	
WIDTH 42" HEIGHT 29"						
	40 x 72 x 29	(2) Y	SLXL4272SW	\$2,866	\$3,043	\$3,266
	42 x 84 x 29	(2) Y	SLXL4284SW	\$3,115	\$3,324	\$3,585
	42 x 96 x 29	(2) Y	SLXL4296SW	\$3,353	\$3,568	\$3,837

• For additional table sizes at 42" wide, use 48" wide sizes/pricing below- specify model # accordingly: (42" x 144" x 29" = SLXL42144SW)

SIZE	BASE INFO #, Style	MODEL #	ABS 1 S	ABS 2 M	ABS 3 KV	
WIDTH 48" HEIGHT 29"						
	48 x 84 x 29	(2) Y	SLXL4884SW	\$3,526	\$3,731	\$3,988
	48 x 96 x 29	(2) Y	SLXL4896SW	\$3,699	\$3,923	\$4,204
	48 x 108 x 29	(2) Y	SLXL48108SW	\$4,347	\$4,590	\$4,894
	* 48 x 120 x 29	(2) Y / (1) T	SLXL48120SW	\$5,539	\$5,801	\$6,128
	* 48 x 144 x 29	(2) Y / (1) T	SLXL48144SW	\$5,963	\$6,262	\$6,636
	* 48 x 156 x 29	(2) Y / (2) T	SLXL48156SW	\$7,290	\$7,607	\$8,005
	* 48 x 168 x 29	(2) Y / (2) T	SLXL48168SW	\$7,336	\$7,672	\$8,094
	* 48 x 180 x 29	(2) Y / (2) T	SLXL48180SW	\$7,680	\$8,035	\$8,480
	** 48 x 192 x 29	(2) Y / (3) T	SLXL48192SW	\$8,716	\$9,090	\$9,558
	** 48 x 204 x 29	(2) Y / (3) T	SLXL48204SW	\$9,125	\$9,517	\$10,009
	** 48 x 216 x 29	(2) Y / (4) T	SLXL48216SW	\$9,170	\$9,581	\$10,094
	** 48 x 228 x 29	(2) Y / (4) T	SLXL48228SW	\$9,836	\$10,266	\$10,804
** 48 x 240 x 29	(2) Y / (4) T	SLXL48240SW	\$10,249	\$10,698	\$11,260	

WIDTH 54" | HEIGHT 29" Use 60" wide sizes/pricing below- specify model # accordingly: (54" x 96" x 29" = SLXL5496SW)

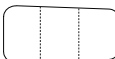
SIZE	BASE INFO #, Style	MODEL #	ABS 1 S	ABS 2 M	ABS 3 KV	
WIDTH 60" HEIGHT 29"						
	60 x 84 x 29	(2) Y	SLXL6084SW	\$3,992	\$4,216	\$4,616
	60 x 96 x 29	(2) Y	SLXL6096SW	\$4,273	\$4,516	\$4,950
	60 x 108 x 29	(2) Y	SLXL60108SW	\$4,968	\$5,230	\$5,696
	* 60 x 120 x 29	(2) Y / (1) T	SLXL60120SW	\$5,967	\$6,248	\$6,748
	* 60 x 144 x 29	(2) Y / (1) T	SLXL60144SW	\$6,342	\$6,660	\$7,227
	* 60 x 156 x 29	(2) Y / (2) T	SLXL60156SW	\$7,733	\$8,069	\$8,669
	* 60 x 168 x 29	(2) Y / (2) T	SLXL60168SW	\$7,920	\$8,275	\$8,909
	* 60 x 180 x 29	(2) Y / (2) T	SLXL60180SW	\$8,202	\$8,576	\$9,243
	** 60 x 192 x 29	(2) Y / (3) T	SLXL60192SW	\$9,378	\$9,771	\$10,471
	** 60 x 204 x 29	(2) Y / (3) T	SLXL60204SW	\$9,721	\$10,132	\$10,866
	** 60 x 216 x 29	(2) Y / (4) T	SLXL60216SW	\$9,908	\$10,338	\$11,105
	** 60 x 228 x 29	(2) Y / (4) T	SLXL60228SW	\$10,510	\$10,959	\$11,759
** 60 x 240 x 29	(2) Y / (4) T	SLXL60240SW	\$11,065	\$11,533	\$12,366	



HPL TOPS | 44 standard HPL finishes

METAL BASES | 11 powder coat finishes

EDGES | matching & coordinating finishes in the following options:

ABS 1: PVC-free impact resistant flat edge (S)

ABS 2: Multi-Ply "Plywood Look" flat vinyl edge (M)

ABS 3: Knife (KV), 1/2" Flat edge- bevel painted in a companion color

- Refer to edge code, above in (), when pricing below -



Standard Features:

- Adjustable leveling glides included.
- Power/Data options available, see Power/Data Solutions page.
- Wire management, grommets, etc. available, consult factory.

(*) = 2-Piece Top. (**) = 3-Piece Top Spline & Joint Fasteners included with table.

NOTE: Woodgrain pattern alignment between multiple tops not guaranteed.

SIZE	BASE INFO #, Style	MODEL #	ABS 1 S	ABS 2 M	ABS 3 KV	
WIDTH 42" HEIGHT 42"						
	40 x 72 x 42	(2) Y	SLXL427242SW	\$3,239	\$3,417	\$3,639
	42 x 84 x 42	(2) Y	SLXL428442SW	\$3,489	\$3,697	\$3,959
	42 x 96 x 42	(2) Y	SLXL429642SW	\$3,727	\$3,942	\$4,211

• For additional tables at 42" wide, use 48" wide sizes/pricing below- specify model # accordingly: (42" x 144" x 42" = SLXL4214442SW)

WIDTH 48" HEIGHT 42"						
	48 x 84 x 42	(2) Y	SLXL488442SW	\$3,899	\$4,105	\$4,362
	48 x 96 x 42	(2) Y	SLXL489642SW	\$4,073	\$4,297	\$4,578
	48 x 108 x 42	(2) Y	SLXL4810842SW	\$4,721	\$4,964	\$5,268
	* 48 x 120 x 42	(2) Y / (1) T	SLXL4812042SW	\$6,100	\$6,361	\$6,689
	* 48 x 144 x 42	(2) Y / (1) T	SLXL4814442SW	\$6,523	\$6,822	\$7,197
	* 48 x 156 x 42	(2) Y / (2) T	SLXL4815642SW	\$8,037	\$8,355	\$8,753
	* 48 x 168 x 42	(2) Y / (2) T	SLXL4816842SW	\$8,083	\$8,420	\$8,841
	* 48 x 180 x 42	(2) Y / (2) T	SLXL4818042SW	\$8,428	\$8,783	\$9,227
	** 48 x 192 x 42	(2) Y / (3) T	SLXL4819242SW	\$9,651	\$10,024	\$10,492
	** 48 x 204 x 42	(2) Y / (3) T	SLXL4820442SW	\$10,059	\$10,452	\$10,943
	** 48 x 216 x 42	(2) Y / (4) T	SLXL4821642SW	\$10,105	\$10,515	\$11,029
	** 48 x 228 x 42	(2) Y / (4) T	SLXL4822842SW	\$10,771	\$11,200	\$11,739
	** 48 x 240 x 42	(2) Y / (4) T	SLXL4824042SW	\$11,184	\$11,632	\$12,194

WIDTH 54" | HEIGHT 42" Use 60" wide sizes/pricing below- specify model # accordingly: (54" x 96" x 42" = SLXL549642SW)

WIDTH 60" HEIGHT 42"						
	60 x 84 x 42	(2) Y	SLXL608442SW	\$4,366	\$4,590	\$4,990
	60 x 96 x 42	(2) Y	SLXL609642SW	\$4,647	\$4,890	\$5,324
	60 x 108 x 42	(2) Y	SLXL6010842SW	\$5,342	\$5,603	\$6,070
	* 60 x 120 x 42	(2) Y / (1) T	SLXL6012042SW	\$6,528	\$6,808	\$7,309
	* 60 x 144 x 42	(2) Y / (1) T	SLXL6014442SW	\$6,903	\$7,221	\$7,788
	* 60 x 156 x 42	(2) Y / (2) T	SLXL6015642SW	\$8,480	\$8,817	\$9,417
	* 60 x 168 x 42	(2) Y / (2) T	SLXL6016842SW	\$8,668	\$9,023	\$9,656
	* 60 x 180 x 42	(2) Y / (2) T	SLXL6018042SW	\$8,949	\$9,323	\$9,990
	** 60 x 192 x 42	(2) Y / (3) T	SLXL6019242SW	\$10,313	\$10,705	\$11,406
	** 60 x 204 x 42	(2) Y / (3) T	SLXL6020442SW	\$10,655	\$11,066	\$11,800
	** 60 x 216 x 42	(2) Y / (4) T	SLXL6021642SW	\$10,843	\$11,273	\$12,040
	** 60 x 228 x 42	(2) Y / (4) T	SLXL6022842SW	\$11,444	\$11,893	\$12,693
	** 60 x 240 x 42	(2) Y / (4) T	SLXL6024042SW	\$12,000	\$12,467	\$13,301

• To specify 36" high tables, use 42" high sizes/pricing above & adjust model # accordingly: (60" x 84" x 36" = SLXL608436SW)



HPL TOPS | 44 standard HPL finishes

METAL BASES | 11 powder coat finishes

EDGES | matching & coordinating finishes in the following options:

ABS 1: PVC-free impact resistant flat edge (S)

ABS 2: Multi-Ply "Plywood Look" flat vinyl edge (M)

ABS 3: Knife (KV), 1/2" Flat edge- bevel painted in a companion color

- Refer to edge code, above in (), when pricing below -

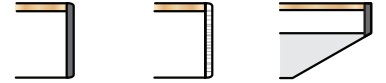

Standard Features:

- Adjustable leveling glides included.
- Power/Data options available, see Power/Data Solutions page.
- Wire management, grommets, etc. available, consult factory.

(*) = 2-Piece Top. (**) = 3-Piece Top Spline & Joint Fasteners included with table.

NOTE: Woodgrain pattern alignment between multiple tops not guaranteed.

SIZE	BASE INFO #, Style	MODEL #	ABS 1 S	ABS 2 M	ABS 3 KV	
WIDTH 42" HEIGHT 29" Use 48" wide sizes/pricing below- specify model # accordingly: (42" x 96" x 29" = SLXL4296BU)						
WIDTH 48" HEIGHT 29"						
	48 x 72 x 29	(2) Y	SLXL4872BU	\$3,393	\$3,579	\$3,813
	48 x 78 x 29	(2) Y	SLXL4878BU	\$3,526	\$3,722	\$3,967
	48 x 84 x 29	(2) Y	SLXL4884BU	\$3,526	\$3,731	\$3,988
	48 x 96 x 29	(2) Y	SLXL4896BU	\$3,699	\$3,923	\$4,204
	48 x 108 x 29	(2) Y	SLXL48108BU	\$4,347	\$4,590	\$4,894
	* 48 x 120 x 29	(2) Y / (1) T	SLXL48120BU	\$5,539	\$5,801	\$6,128
	* 48 x 144 x 29	(2) Y / (1) T	SLXL48144BU	\$5,963	\$6,262	\$6,636
WIDTH 54" HEIGHT 29" Use 60" wide sizes/pricing below- specify model # accordingly: (54" x 96" x 29" = SLXL5496BU)						
WIDTH 60" HEIGHT 29"						
	60 x 72 x 29	(2) Y	SLXL6072BU	\$3,881	\$4,087	\$4,454
	60 x 78 x 29	(2) Y	SLXL6078BU	\$3,992	\$4,207	\$4,590
	60 x 84 x 29	(2) Y	SLXL6084BU	\$3,992	\$4,216	\$4,616
	60 x 96 x 29	(2) Y	SLXL6096BU	\$4,273	\$4,516	\$4,950
	60 x 108 x 29	(2) Y	SLXL60108BU	\$4,968	\$5,230	\$5,696
	* 60 x 120 x 29	(2) Y / (1) T	SLXL60120BU	\$5,967	\$6,248	\$6,748
	* 60 x 144 x 29	(2) Y / (1) T	SLXL60144BU	\$6,342	\$6,660	\$7,227
WIDTH 42" HEIGHT 42" Use 48" wide sizes/pricing below- specify model # accordingly: (42" x 96" x 42" = SLXL429642BU)						
WIDTH 48" HEIGHT 42"						
	48 x 72 x 42	(2) Y	SLXL487242BU	\$3,766	\$3,953	\$4,187
	48 x 78 x 42	(2) Y	SLXL487842BU	\$3,899	\$4,095	\$4,341
	48 x 84 x 42	(2) Y	SLXL488442BU	\$3,899	\$4,105	\$4,362
	48 x 96 x 42	(2) Y	SLXL489642BU	\$4,073	\$4,297	\$4,578
	48 x 108 x 42	(2) Y	SLXL4810842BU	\$4,721	\$4,964	\$5,268
	* 48 x 120 x 42	(2) Y / (1) T	SLXL4812042BU	\$6,100	\$6,361	\$6,689
	* 48 x 144 x 42	(2) Y / (1) T	SLXL4814442BU	\$6,523	\$6,822	\$7,197
WIDTH 54" HEIGHT 42" Use 60" wide sizes/pricing below- specify model # accordingly: (54" x 96" x 42" = SLXL549642BU)						
WIDTH 60" HEIGHT 42"						
	60 x 72 x 42	(2) Y	SLXL607242BU	\$4,255	\$4,442	\$4,775
	60 x 78 x 42	(2) Y	SLXL607842BU	\$4,364	\$4,560	\$4,911
	60 x 84 x 42	(2) Y	SLXL608442BU	\$4,366	\$4,590	\$4,990
	60 x 96 x 42	(2) Y	SLXL609642BU	\$4,647	\$4,890	\$5,324
	60 x 108 x 42	(2) Y	SLXL6010842BU	\$5,342	\$5,603	\$6,070
	* 60 x 120 x 42	(2) Y / (1) T	SLXL6012042BU	\$6,528	\$6,808	\$7,309
	* 60 x 144 x 42	(2) Y / (1) T	SLXL6014442BU	\$6,903	\$7,221	\$7,788

• To specify 36" high tables, use 42" high sizes/pricing above & adjust model # accordingly: (60" x 84" x 36" = SLXL608436BU)



HPL TOPS | 44 standard HPL finishes

METAL BASES | 11 powder coat finishes

EDGES | matching & coordinating finishes in the following options:

ABS 1: PVC-free impact resistant flat edge (S)

ABS 2: Multi-Ply "Plywood Look" flat vinyl edge (M)

ABS 3: Knife (KV), 1/2" Flat edge- bevel painted in a companion color

- Refer to edge code, above in (), when pricing below -

Standard Features:

- Adjustable leveling glides included.
- Power/Data options available, see Power/Data Solutions page.
- Wire management, grommets, etc. available, consult factory.

(*) = 2-Piece Top. (**) = 3-Piece Top Spline & Joint Fasteners included with table.

NOTE: Woodgrain pattern alignment between multiple tops not guaranteed.

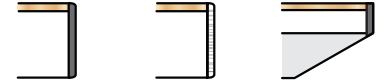

SIZE	BASE INFO #, Style	MODEL #	ABS 1 S	ABS 2 M	ABS 3 KV	
SOFT PENTAGON HEIGHT 29"						
	48 x 84 x 29	(2) Y	SLXL4884SP	\$3,784	\$3,990	\$4,247
	48 x 96 x 29	(2) Y	SLXL4896SP	\$3,958	\$4,182	\$4,463
	54 x 96 x 29	(2) Y	SLXL5496SP	\$4,532	\$4,775	\$5,209
	60 x 96 x 29	(2) Y	SLXL6096SP	\$4,532	\$4,775	\$5,209
SOFT PENTAGON HEIGHT 42"						
	48 x 84 x 42	(2) Y	SLXL488442SP	\$4,158	\$4,364	\$4,621
	48 x 96 x 42	(2) Y	SLXL489642SP	\$4,332	\$4,556	\$4,837
	54 x 96 x 42	(2) Y	SLXL549642SP	\$4,906	\$5,149	\$5,582
	60 x 96 x 42	(2) Y	SLXL609642SP	\$4,906	\$5,149	\$5,582
MEDIA SHARE (MS) HEIGHT 29"						
	48 x 81 x 29	(2) Y	SLXL4881MS	\$4,333	\$4,557	\$4,838
	54 x 92 x 29	(2) Y	SLXL5492MS	\$4,522	\$4,765	\$5,070
	60 x 102 x 29	(2) Y	SLXL60102MS	\$5,218	\$5,498	\$5,999
MEDIA SHARE (MS) HEIGHT 42"						
	48 x 81 x 42	(2) Y	SLXL488142MS	\$4,715	\$4,939	\$5,220
	54 x 92 x 42	(2) Y	SLXL549242MS	\$4,905	\$5,148	\$5,452
	60 x 102 x 42	(2) Y	SLXL6010242MS	\$5,601	\$5,881	\$6,381

• **NOTE PRIOR TO ORDERING** •
 Larger size tops are heavy.
 Verify site conditions for accessible delivery & install-
 such as elevator access, building entry etc.



HPL TOPS | 44 standard HPL finishes

METAL BASES | 11 powder coat finishes

EDGES | matching & coordinating finishes in the following options:

ABS 1: PVC-free impact resistant flat edge (S)

ABS 2: Multi-Ply "Plywood Look" flat vinyl edge (M)

ABS 3: Knife (KV), 1/2" Flat edge- bevel painted in a companion color

- Refer to edge code, above in (), when pricing below -



Standard Features:

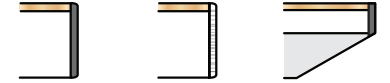

- Adjustable leveling glides included.
- Power/Data options available, see Power/Data Solutions page.
- Wire management, grommets, etc. available, consult factory.

(*) = 2-Piece Top. (**) = 3-Piece Top Spline & Joint Fasteners included with table.

NOTE: Woodgrain pattern alignment between multiple tops not guaranteed.



SIZE	BASE INFO #, Style	MODEL #	ABS 1 S	ABS 2 M	ABS 3 KV	
MEDIA PEAR HEIGHT 29"						
	54 x 72 x 29	(2) Y	SLXL5472MP	\$4,140	\$4,346	\$4,712
	60 x 72 x 29	(2) Y	SLXL6072MP	\$4,140	\$4,346	\$4,712
	54 x 84 x 29	(2) Y	SLXL5484MP	\$4,251	\$4,475	\$4,875
	60 x 84 x 29	(2) Y	SLXL6084MP	\$4,251	\$4,475	\$4,875
	54 x 96 x 29	(2) Y	SLXL5496MP	\$4,532	\$4,775	\$5,209
	60 x 96 x 29	(2) Y	SLXL6096MP	\$4,532	\$4,775	\$5,209
	54 x 108 x 29	(2) Y	SLXL54108MP	\$5,227	\$5,488	\$5,955
	60 x 108 x 29	(2) Y	SLXL60108MP	\$5,227	\$5,488	\$5,955
	* 54 x 120 x 29	(2) Y / (1) T	SLXL54120MP	\$6,341	\$6,622	\$7,122
	* 60 x 120 x 29	(2) Y / (1) T	SLXL60120MP	\$6,341	\$6,622	\$7,122

MEDIA PEAR HEIGHT 42"						
	54 x 72 x 42	(2) Y	SLXL547242MP	\$4,514	\$4,719	\$5,086
	60 x 72 x 42	(2) Y	SLXL607242MP	\$4,514	\$4,719	\$5,086
	54 x 84 x 42	(2) Y	SLXL548442MP	\$4,624	\$4,849	\$5,249
	60 x 84 x 42	(2) Y	SLXL608442MP	\$4,624	\$4,849	\$5,249
	54 x 96 x 42	(2) Y	SLXL549642MP	\$4,906	\$5,149	\$5,582
	60 x 96 x 42	(2) Y	SLXL609642MP	\$4,906	\$5,149	\$5,582
	54 x 108 x 42	(2) Y	SLXL5410842MP	\$5,600	\$5,862	\$6,329
	60 x 108 x 42	(2) Y	SLXL6010842MP	\$5,600	\$5,862	\$6,329
	* 54 x 120 x 42	(2) Y / (1) T	SLXL5412042MP	\$6,902	\$7,182	\$7,682
	* 60 x 120 x 42	(2) Y / (1) T	SLXL6012042MP	\$6,902	\$7,182	\$7,682

• **NOTE PRIOR TO ORDERING** •

Larger size tops are heavy.

Verify site conditions for accessible delivery & install-
such as elevator access, building entry etc.



HPL TOPS | 44 standard HPL finishes

METAL BASES | 11 powder coat finishes

EDGES | matching & coordinating finishes in the following options:

ABS 1: PVC-free impact resistant flat edge (S)

ABS 2: Multi-Ply "Plywood Look" flat vinyl edge (M)

ABS 3: Knife (KV), 1/2" Flat edge- bevel painted in a companion color

- Refer to edge code, above in (), when pricing below -

Standard Features:

- Adjustable leveling glides included.
- Power/Data options available, see Power/Data Solutions page.
- Wire management, grommets, etc. available, consult factory.

(*) = 2-Piece Top. (**) = 3-Piece Top Spline & Joint Fasteners included with table.

NOTE: Woodgrain pattern alignment between multiple tops not guaranteed.

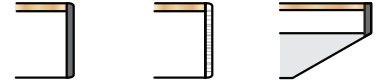

SIZE	BASE INFO #, Style	MODEL #	ABS 1 S	ABS 2 M	ABS 3 KV	
MEDIA WEDGE HEIGHT 29"						
	54 x 72 x 29	(2) Y	SLXL5472MW	\$4,140	\$4,346	\$4,712
	60 x 72 x 29	(2) Y	SLXL6072MW	\$4,140	\$4,346	\$4,712
	54 x 84 x 29	(2) Y	SLXL5484MW	\$4,251	\$4,475	\$4,875
	60 x 84 x 29	(2) Y	SLXL6084MW	\$4,251	\$4,475	\$4,875
	54 x 96 x 29	(2) Y	SLXL5496MW	\$4,532	\$4,775	\$5,209
	60 x 96 x 29	(2) Y	SLXL6096MW	\$4,532	\$4,775	\$5,209
	54 x 108 x 29	(2) Y	SLXL54108MW	\$5,227	\$5,488	\$5,955
	60 x 108 x 29	(2) Y	SLXL60108MW	\$5,227	\$5,488	\$5,955
	* 54 x 120 x 29	(2) Y / (1) T	SLXL54120MW	\$6,341	\$6,622	\$7,122
	* 60 x 120 x 29	(2) Y / (1) T	SLXL60120MW	\$6,341	\$6,622	\$7,122

MEDIA WEDGE HEIGHT 42"						
	54 x 72 x 42	(2) Y	SLXL547242MW	\$4,514	\$4,719	\$5,086
	60 x 72 x 42	(2) Y	SLXL607242MW	\$4,514	\$4,719	\$5,086
	54 x 84 x 42	(2) Y	SLXL548442MW	\$4,624	\$4,849	\$5,249
	60 x 84 x 42	(2) Y	SLXL608442MW	\$4,624	\$4,849	\$5,249
	54 x 96 x 42	(2) Y	SLXL549642MW	\$4,906	\$5,149	\$5,582
	60 x 96 x 42	(2) Y	SLXL609642MW	\$4,906	\$5,149	\$5,582
	54 x 108 x 42	(2) Y	SLXL5410842MW	\$5,600	\$5,862	\$6,329
	60 x 108 x 42	(2) Y	SLXL6010428MW	\$5,600	\$5,862	\$6,329
	* 54 x 120 x 42	(2) Y / (1) T	SLXL5412042MW	\$6,902	\$7,182	\$7,682
	* 60 x 120 x 42	(2) Y / (1) T	SLXL6012042MW	\$6,902	\$7,182	\$7,682

• **NOTE PRIOR TO ORDERING** •

Larger size tops are heavy.

Verify site conditions for accessible delivery & install-
such as elevator access, building entry etc.



PANEL BASE SERIES

PANEL BASE SERIES | 1-1/4" PANEL BASE CONFERENCE TABLE



HPL TOPS | 44 standard HPL finishes

EDGES | matching & coordinating finishes in the following options:

ABS 1: PVC-free impact resistant flat edge (S)

ABS 2: Multi-Ply "Plywood Look" flat vinyl edge (M)

ABS 3: Knife (KV), 1/2" Flat edge- bevel painted in a companion color

- Refer to edge code, above in (), when pricing below -

Standard Features:

- Panel legs are 1-1/4" thick, with adjustable leveling glides included.
- Stretcher box provided between panel legs for stability and wire management.
- Power/Data options available, see Power/Data Solutions page.
- Additional wire management, grommets, etc. available, consult factory.

(*) Refers to a 2-Piece Top. Spline and Joint Fasteners included with table.

NOTE: Woodgrain pattern alignment between two tops not guaranteed.

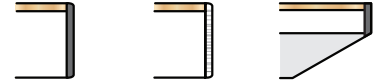

SIZE	BASE INFO #, Style	MODEL #	ABS 1 S	ABS 2 M	ABS 3 KV	
RECTANGLE SHAPE TOP (SQ)						
	42 x 84 x 29	(2) 1.25" Panel Legs	CSP4284SQ	\$1,498	\$1,707	\$1,771
	42 x 96 x 29	(2) 1.25" Panel Legs	CSP4296SQ	\$1,739	\$1,963	\$2,032
	48 x 96 x 29	(2) 1.25" Panel Legs	CSP4896SQ	\$1,836	\$2,060	\$2,129
	* 48 x 120 x 29	(3) 1.25" Panel Legs	CSP48120SQ	\$2,479	\$2,741	\$2,962
	* 60 x 120 x 29	(3) 1.25" Panel Legs	CSP60120SQ	\$2,813	\$3,094	\$3,331
	* 48 x 144 x 29	(3) 1.25" Panel Legs	CSP48144SQ	\$3,003	\$3,302	\$3,555
	* 60 x 144 x 29	(3) 1.25" Panel Legs	CSP60144SQ	\$3,494	\$3,812	\$4,081
	* 48 x 168 x 29	(4) 1.25" Panel Legs	CSP48168SQ	\$3,379	\$3,713	\$3,996
	* 60 x 168 x 29	(4) 1.25" Panel Legs	CSP60168SQ	\$3,820	\$4,175	\$4,475
WEDGE SHAPE TOP (WD)						
	42 x 84 x 29	(2) 1.25" Panel Legs	CSP4284WD	\$1,624	\$1,833	\$1,897
	42 x 96 x 29	(2) 1.25" Panel Legs	CSP4296WD	\$1,884	\$2,108	\$2,177
	48 x 96 x 29	(2) 1.25" Panel Legs	CSP4896WD	\$2,000	\$2,224	\$2,293
	* 48 x 120 x 29	(3) 1.25" Panel Legs	CSP48120WD	\$2,685	\$2,946	\$3,168
	* 60 x 120 x 29	(3) 1.25" Panel Legs	CSP60120WD	\$3,070	\$3,351	\$3,588
	* 48 x 144 x 29	(3) 1.25" Panel Legs	CSP48144WD	\$3,250	\$3,549	\$3,802
	* 60 x 144 x 29	(3) 1.25" Panel Legs	CSP60144WD	\$3,803	\$4,121	\$4,389
	* 48 x 168 x 29	(4) 1.25" Panel Legs	CSP48168WD	\$3,668	\$4,002	\$4,285
	* 60 x 168 x 29	(4) 1.25" Panel Legs	CSP60168WD	\$4,180	\$4,535	\$4,836
BOAT SHAPE TOP (BT)						
	42 x 84 x 29	(2) 1.25" Panel Legs	CSP4284BT	\$1,656	\$1,865	\$1,929
	42 x 96 x 29	(2) 1.25" Panel Legs	CSP4296BT	\$1,919	\$2,143	\$2,212
	48 x 96 x 29	(2) 1.25" Panel Legs	CSP4896BT	\$2,042	\$2,266	\$2,335
	* 48 x 120 x 29	(3) 1.25" Panel Legs	CSP48120BT	\$2,736	\$2,998	\$3,219
	* 60 x 120 x 29	(3) 1.25" Panel Legs	CSP60120BT	\$3,134	\$3,414	\$3,652
	* 48 x 144 x 29	(3) 1.25" Panel Legs	CSP48144BT	\$3,312	\$3,611	\$3,864
	* 60 x 144 x 29	(3) 1.25" Panel Legs	CSP60144BT	\$3,880	\$4,198	\$4,467
	* 48 x 168 x 29	(4) 1.25" Panel Legs	CSP48168BT	\$3,739	\$4,073	\$4,356
	* 60 x 168 x 29	(4) 1.25" Panel Legs	CSP60168BT	\$4,269	\$4,625	\$4,925



HPL TOPS | 44 standard HPL finishes

EDGES | matching & coordinating finishes in the following options:

ABS 1: PVC-free impact resistant flat edge (**S**)

ABS 2: Multi-Ply "Plywood Look" flat vinyl edge (**M**)

ABS 3: Knife (**KV**), 1/2" Flat edge- bevel painted in a companion color

- Refer to edge code, above in (), when pricing below -

Standard Features:

- Panel legs are 1-1/4" thick, with adjustable leveling glides included.
- Stretcher box provided between panel legs for stability and wire management.
- Power/Data options available, see Power/Data Solutions page.
- Additional wire management, grommets, etc. available, consult factory.

(*) Refers to a 2-Piece Top. Spline and Joint Fasteners included with table.

NOTE: Woodgrain pattern alignment between two tops not guaranteed.

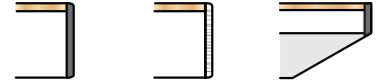

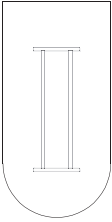
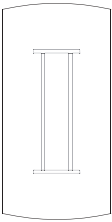
SIZE	BASE INFO #, Style	MODEL #	ABS 1 S	ABS 2 M	ABS 3 KV	
DIAMOND SHAPE TOP (DM)						
	42 x 84 x 29	(2) 1.25" Panel Legs	CSP4284DM	\$1,656	\$1,865	\$1,929
	42 x 96 x 29	(2) 1.25" Panel Legs	CSP4296DM	\$1,919	\$2,143	\$2,212
	48 x 96 x 29	(2) 1.25" Panel Legs	CSP4896DM	\$2,042	\$2,266	\$2,335
	* 48 x 120 x 29	(3) 1.25" Panel Legs	CSP48120DM	\$2,736	\$2,998	\$3,219
	* 60 x 120 x 29	(3) 1.25" Panel Legs	CSP60120DM	\$3,134	\$3,414	\$3,652
	* 48 x 144 x 29	(3) 1.25" Panel Legs	CSP48144DM	\$3,312	\$3,611	\$3,864
	* 60 x 144 x 29	(3) 1.25" Panel Legs	CSP60144DM	\$3,880	\$4,198	\$4,467
	* 48 x 168 x 29	(4) 1.25" Panel Legs	CSP48168DM	\$3,739	\$4,073	\$4,356
	* 60 x 168 x 29	(4) 1.25" Panel Legs	CSP60168DM	\$4,269	\$4,625	\$4,925
BULLET SHAPE TOP (BU)						
	42 x 84 x 29	(2) 1.25" Panel Legs	CSP4284BU	\$1,656	\$1,838	\$1,894
	42 x 96 x 29	(2) 1.25" Panel Legs	CSP4296BU	\$1,919	\$2,120	\$2,182
	48 x 96 x 29	(2) 1.25" Panel Legs	CSP4896BU	\$2,042	\$2,250	\$2,315
	* 48 x 120 x 29	(3) 1.25" Panel Legs	CSP48120BU	\$2,736	\$2,982	\$3,190
	* 60 x 120 x 29	(3) 1.25" Panel Legs	CSP60120BU	\$3,134	\$3,399	\$3,623
	* 48 x 144 x 29	(3) 1.25" Panel Legs	CSP48144BU	\$3,312	\$3,595	\$3,835
	* 60 x 144 x 29	(3) 1.25" Panel Legs	CSP60144BU	\$3,880	\$4,182	\$4,438
	* 48 x 168 x 29	(4) 1.25" Panel Legs	CSP48168BU	\$3,739	\$4,060	\$4,331
	* 60 x 168 x 29	(4) 1.25" Panel Legs	CSP60168BU	\$4,269	\$4,609	\$4,896
BOW END SHAPE TOP (BE)						
	42 x 84 x 29	(2) 1.25" Panel Legs	CSP4284BE	\$1,656	\$1,865	\$1,929
	42 x 96 x 29	(2) 1.25" Panel Legs	CSP4296BE	\$1,919	\$2,143	\$2,212
	48 x 96 x 29	(2) 1.25" Panel Legs	CSP4896BE	\$2,042	\$2,266	\$2,335
	* 48 x 120 x 29	(3) 1.25" Panel Legs	CSP48120BE	\$2,736	\$2,998	\$3,219
	* 60 x 120 x 29	(3) 1.25" Panel Legs	CSP60120BE	\$3,134	\$3,414	\$3,652
	* 48 x 144 x 29	(3) 1.25" Panel Legs	CSP48144BE	\$3,312	\$3,611	\$3,864
	* 60 x 144 x 29	(3) 1.25" Panel Legs	CSP60144BE	\$3,880	\$4,198	\$4,467
	* 48 x 168 x 29	(4) 1.25" Panel Legs	CSP48168BE	\$3,739	\$4,073	\$4,356
	* 60 x 168 x 29	(4) 1.25" Panel Legs	CSP60168BE	\$4,269	\$4,625	\$4,925

PANEL BASE SERIES | 1-1/4" PANEL BASE CONFERENCE TABLE



HPL TOPS | 44 standard HPL finishes

EDGES | matching & coordinating finishes in the following options:

ABS 1: PVC-free impact resistant flat edge (S)

ABS 2: Multi-Ply "Plywood Look" flat vinyl edge (M)

ABS 3: Knife (KV), 1/2" Flat edge- bevel painted in a companion color

- Refer to edge code, above in (), when pricing below -

Standard Features:

- Panel legs are 1-1/4" thick, with adjustable leveling glides included.
- Stretcher box provided between panel legs for stability and wire management.
- Power/Data options available, see Power/Data Solutions page.
- Additional wire management, grommets, etc. available, consult factory.

(*) Refers to a 2-Piece Top. Spline and Joint Fasteners included with table.

NOTE: Woodgrain pattern alignment between two tops not guaranteed.

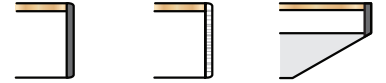

SIZE	BASE INFO #, Style	MODEL #	ABS 1	ABS 2	ABS 3	
			S	M	KV	
RACETRACK SHAPE TOP (RT)						
	42 x 84 x 29	(2) 1.25" Panel Legs	CSP4284RT	\$1,672	\$1,840	\$1,892
	42 x 96 x 29	(2) 1.25" Panel Legs	CSP4296RT	\$1,935	\$2,122	\$2,179
	48 x 96 x 29	(2) 1.25" Panel Legs	CSP4896RT	\$2,064	\$2,257	\$2,316
	* 48 x 120 x 29	(3) 1.25" Panel Legs	CSP48120RT	\$2,762	\$2,992	\$3,187
	* 60 x 120 x 29	(3) 1.25" Panel Legs	CSP60120RT	\$3,167	\$3,416	\$3,627
	* 48 x 144 x 29	(3) 1.25" Panel Legs	CSP48144RT	\$3,344	\$3,611	\$3,838
	* 60 x 144 x 29	(3) 1.25" Panel Legs	CSP60144RT	\$3,919	\$4,206	\$4,448
	* 48 x 168 x 29	(4) 1.25" Panel Legs	CSP48168RT	\$3,775	\$4,079	\$4,337
	* 60 x 168 x 29	(4) 1.25" Panel Legs	CSP60168RT	\$4,315	\$4,638	\$4,911
BOAT ROUNDED SHAPE TOP (BR)						
	42 x 84 x 29	(2) 1.25" Panel Legs	CSP4284BR	\$1,672	\$1,880	\$1,945
	42 x 96 x 29	(2) 1.25" Panel Legs	CSP4296BR	\$1,935	\$2,159	\$2,228
	48 x 96 x 29	(2) 1.25" Panel Legs	CSP4896BR	\$2,064	\$2,288	\$2,357
	* 48 x 120 x 29	(3) 1.25" Panel Legs	CSP48120BR	\$2,762	\$3,023	\$3,245
	* 60 x 120 x 29	(3) 1.25" Panel Legs	CSP60120BR	\$3,167	\$3,448	\$3,685
	* 48 x 144 x 29	(3) 1.25" Panel Legs	CSP48144BR	\$3,344	\$3,643	\$3,896
	* 60 x 144 x 29	(3) 1.25" Panel Legs	CSP60144BR	\$3,919	\$4,237	\$4,506
	* 48 x 168 x 29	(4) 1.25" Panel Legs	CSP48168BR	\$3,775	\$4,109	\$4,391
	* 60 x 168 x 29	(4) 1.25" Panel Legs	CSP60168BR	\$4,315	\$4,670	\$4,970
OVAL SHAPE TOP (OV)						
	42 x 84 x 29	(2) 1.25" Panel Legs	CSP4284OV	\$1,672	\$1,829	\$1,877
	42 x 96 x 29	(2) 1.25" Panel Legs	CSP4296OV	\$1,935	\$2,111	\$2,165
	48 x 96 x 29	(2) 1.25" Panel Legs	CSP4896OV	\$2,064	\$2,245	\$2,301
	* 48 x 120 x 29	(3) 1.25" Panel Legs	CSP48120OV	\$2,762	\$2,977	\$3,160
	* 60 x 120 x 29	(3) 1.25" Panel Legs	CSP60120OV	\$3,167	\$3,392	\$3,583
	* 48 x 144 x 29	(3) 1.25" Panel Legs	CSP48144OV	\$3,344	\$3,594	\$3,805
	* 60 x 144 x 29	(3) 1.25" Panel Legs	CSP60144OV	\$3,919	\$4,188	\$4,415
	* 48 x 168 x 29	(4) 1.25" Panel Legs	CSP48168OV	\$3,775	\$4,099	\$4,374
	* 60 x 168 x 29	(4) 1.25" Panel Legs	CSP60168OV	\$4,315	\$4,658	\$4,949

PANEL BASE SERIES

THICK PANEL BASE CONFERENCE TABLE



HPL TOPS | 44 standard HPL finishes

EDGES | matching & coordinating finishes in the following options:

ABS 1: PVC-free impact resistant flat edge (**S**)

ABS 2: Multi-Ply "Plywood Look" flat vinyl edge (**M**)

ABS 3: Knife (**KV**), 1/2" Flat edge- bevel painted in a companion color

Standard Features:

- Panel legs are 6" thick, with removable access panel for wire management.
- Stretcher box provided between panel legs for stability and additional wire management.
- Adjustable leveling glides included.
- Power/Data options available, see Power/Data Solutions page.
- Consult factory for additional accessory options.

- Refer to edge code, above in (), when pricing below -

(*) Refers to a 2-Piece Top. Spline and Joint Fasteners included with table.
NOTE: Woodgrain pattern alignment between two tops not guaranteed.



SIZE	BASE INFO #, Style	MODEL #	ABS 1 S	ABS 2 M	ABS 3 KV	
RECTANGLE SHAPE TOP (SQ)						
	42 x 84 x 29	(2) 6" Panel Legs	CTPB4284SQ	\$2,114	\$2,323	\$2,387
	42 x 96 x 29	(2) 6" Panel Legs	CTPB4296SQ	\$2,305	\$2,530	\$2,599
	48 x 96 x 29	(2) 6" Panel Legs	CTPB4896SQ	\$2,406	\$2,630	\$2,699
	* 48 x 120 x 29	(3) 6" Panel Legs	CTPB48120SQ	\$3,093	\$3,355	\$3,576
	* 60 x 120 x 29	(3) 6" Panel Legs	CTPB60120SQ	\$3,404	\$3,685	\$3,922
	* 48 x 144 x 29	(3) 6" Panel Legs	CTPB48144SQ	\$3,877	\$4,176	\$4,429
	* 60 x 144 x 29	(3) 6" Panel Legs	CTPB60144SQ	\$4,285	\$4,603	\$4,872
	* 48 x 168 x 29	(4) 6" Panel Legs	CTPB48168SQ	\$4,456	\$4,790	\$5,073
* 60 x 168 x 29	(4) 6" Panel Legs	CTPB60168SQ	\$4,883	\$5,238	\$5,538	
WEDGE SHAPE TOP (WD)						
	42 x 84 x 29	(2) 6" Panel Legs	CTPB4284WD	\$2,245	\$2,454	\$2,518
	42 x 96 x 29	(2) 6" Panel Legs	CTPB4296WD	\$2,456	\$2,680	\$2,749
	48 x 96 x 29	(2) 6" Panel Legs	CTPB4896WD	\$2,577	\$2,802	\$2,871
	* 48 x 120 x 29	(3) 6" Panel Legs	CTPB48120WD	\$3,307	\$3,569	\$3,790
	* 60 x 120 x 29	(3) 6" Panel Legs	CTPB60120WD	\$3,672	\$3,953	\$4,190
	* 48 x 144 x 29	(3) 6" Panel Legs	CTPB48144WD	\$4,135	\$4,434	\$4,687
	* 60 x 144 x 29	(3) 6" Panel Legs	CTPB60144WD	\$4,607	\$4,925	\$5,193
	* 48 x 168 x 29	(4) 6" Panel Legs	CTPB48168WD	\$4,759	\$5,093	\$5,375
* 60 x 168 x 29	(4) 6" Panel Legs	CTPB60168WD	\$5,258	\$5,613	\$5,913	
BOAT SHAPE TOP (BT)						
	42 x 84 x 29	(2) 6" Panel Legs	CTPB4284BT	\$2,279	\$2,487	\$2,551
	42 x 96 x 29	(2) 6" Panel Legs	CTPB4296BT	\$2,493	\$2,717	\$2,786
	48 x 96 x 29	(2) 6" Panel Legs	CTPB4896BT	\$2,621	\$2,845	\$2,914
	* 48 x 120 x 29	(3) 6" Panel Legs	CTPB48120BT	\$3,361	\$3,623	\$3,844
	* 60 x 120 x 29	(3) 6" Panel Legs	CTPB60120BT	\$3,740	\$4,020	\$4,258
	* 48 x 144 x 29	(3) 6" Panel Legs	CTPB48144BT	\$4,198	\$4,497	\$4,750
	* 60 x 144 x 29	(3) 6" Panel Legs	CTPB60144BT	\$4,687	\$5,005	\$5,274
	* 48 x 168 x 29	(4) 6" Panel Legs	CTPB48168BT	\$4,832	\$5,166	\$5,448
* 60 x 168 x 29	(4) 6" Panel Legs	CTPB60168BT	\$5,351	\$5,706	\$6,007	



HPL TOPS | 44 standard HPL finishes

EDGES | matching & coordinating finishes in the following options:

ABS 1: PVC-free impact resistant flat edge (**S**)

ABS 2: Multi-Ply "Plywood Look" flat vinyl edge (**M**)

ABS 3: Knife (**KV**), 1/2" Flat edge- bevel painted in a companion color

Standard Features:

- Panel legs are 6" thick, with removable access panel for wire management.
- Stretcher box provided between panel legs for stability and additional wire management.
- Adjustable leveling glides included.
- Power/Data options available, see Power/Data Solutions page.
- Consult factory for additional accessory options.

- Refer to edge code, above in (), when pricing below -

(*) Refers to a 2-Piece Top. Spline and Joint Fasteners included with table.
NOTE: Woodgrain pattern alignment between two tops not guaranteed.

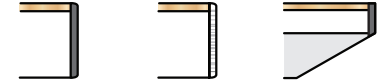

SIZE	BASE INFO #, Style	MODEL #	ABS 1 S	ABS 2 M	ABS 3 KV	
DIAMOND SHAPE TOP (DM)						
	42 x 84 x 29	(2) 6" Panel Legs	CTPB4284DM	\$2,279	\$2,487	\$2,551
	42 x 96 x 29	(2) 6" Panel Legs	CTPB4296DM	\$2,493	\$2,717	\$2,786
	48 x 96 x 29	(2) 6" Panel Legs	CTPB4896DM	\$2,621	\$2,845	\$2,914
	* 48 x 120 x 29	(3) 6" Panel Legs	CTPB48120DM	\$3,361	\$3,623	\$3,844
	* 60 x 120 x 29	(3) 6" Panel Legs	CTPB60120DM	\$3,740	\$4,020	\$4,258
	* 48 x 144 x 29	(3) 6" Panel Legs	CTPB48144DM	\$4,198	\$4,497	\$4,750
	* 60 x 144 x 29	(3) 6" Panel Legs	CTPB60144DM	\$4,687	\$5,005	\$5,274
	* 48 x 168 x 29	(4) 6" Panel Legs	CTPB48168DM	\$4,832	\$5,166	\$5,448
* 60 x 168 x 29	(4) 6" Panel Legs	CTPB60168DM	\$5,351	\$5,706	\$6,007	
BULLET SHAPE TOP (BU)						
	42 x 84 x 29	(2) 6" Panel Legs	CTPB4284BU	\$2,279	\$2,461	\$2,517
	42 x 96 x 29	(2) 6" Panel Legs	CTPB4296BU	\$2,493	\$2,694	\$2,756
	48 x 96 x 29	(2) 6" Panel Legs	CTPB4896BU	\$2,621	\$2,829	\$2,894
	* 48 x 120 x 29	(3) 6" Panel Legs	CTPB48120BU	\$3,361	\$3,607	\$3,815
	* 60 x 120 x 29	(3) 6" Panel Legs	CTPB60120BU	\$3,740	\$4,005	\$4,229
	* 48 x 144 x 29	(3) 6" Panel Legs	CTPB48144BU	\$4,198	\$4,482	\$4,722
	* 60 x 144 x 29	(3) 6" Panel Legs	CTPB60144BU	\$4,687	\$4,989	\$5,245
	* 48 x 168 x 29	(4) 6" Panel Legs	CTPB48168BU	\$4,832	\$5,152	\$5,424
* 60 x 168 x 29	(4) 6" Panel Legs	CTPB60168BU	\$5,351	\$5,691	\$5,978	
BOW END SHAPE TOP (BE)						
	42 x 84 x 29	(2) 6" Panel Legs	CTPB4284BE	\$2,279	\$2,487	\$2,551
	42 x 96 x 29	(2) 6" Panel Legs	CTPB4296BE	\$2,493	\$2,717	\$2,786
	48 x 96 x 29	(2) 6" Panel Legs	CTPB4896BE	\$2,621	\$2,845	\$2,914
	* 48 x 120 x 29	(3) 6" Panel Legs	CTPB48120BE	\$3,361	\$3,623	\$3,844
	* 60 x 120 x 29	(3) 6" Panel Legs	CTPB60120BE	\$3,740	\$4,020	\$4,258
	* 48 x 144 x 29	(3) 6" Panel Legs	CTPB48144BE	\$4,198	\$4,497	\$4,750
	* 60 x 144 x 29	(3) 6" Panel Legs	CTPB60144BE	\$4,687	\$5,005	\$5,274
	* 48 x 168 x 29	(4) 6" Panel Legs	CTPB48168BE	\$4,832	\$5,166	\$5,448
* 60 x 168 x 29	(4) 6" Panel Legs	CTPB60168BE	\$5,351	\$5,706	\$6,007	

PANEL BASE SERIES

THICK PANEL BASE CONFERENCE TABLE



HPL TOPS | 44 standard HPL finishes

EDGES | matching & coordinating finishes in the following options:

ABS 1: PVC-free impact resistant flat edge (**S**)

ABS 2: Multi-Ply "Plywood Look" flat vinyl edge (**M**)

ABS 3: Knife (**KV**), 1/2" Flat edge- bevel painted in a companion color

- Refer to edge code, above in (), when pricing below -

Standard Features:

- Panel legs are 6" thick, with removable access panel for wire management.
- Stretcher box provided between panel legs for stability and additional wire management.
- Adjustable leveling glides included.
- Power/Data options available, see Power/Data Solutions page.
- Consult factory for additional accessory options.

(*) Refers to a 2-Piece Top. Spline and Joint Fasteners included with table.

NOTE: Woodgrain pattern alignment between two tops not guaranteed.



SIZE	BASE INFO #, Style	MODEL #	ABS 1 S	ABS 2 M	ABS 3 KV	
RACETRACK SHAPE TOP (RT)						
	42 x 84 x 29	(2) 6" Panel Legs	CTPB4284RT	\$2,295	\$2,463	\$2,515
	42 x 96 x 29	(2) 6" Panel Legs	CTPB4296RT	\$2,510	\$2,696	\$2,754
	48 x 96 x 29	(2) 6" Panel Legs	CTPB4896RT	\$2,644	\$2,837	\$2,896
	* 48 x 120 x 29	(3) 6" Panel Legs	CTPB48120RT	\$3,388	\$3,618	\$3,813
	* 60 x 120 x 29	(3) 6" Panel Legs	CTPB60120RT	\$3,773	\$4,023	\$4,233
	* 48 x 144 x 29	(3) 6" Panel Legs	CTPB48144RT	\$4,232	\$4,499	\$4,726
	* 60 x 144 x 29	(3) 6" Panel Legs	CTPB60144RT	\$4,728	\$5,015	\$5,257
	* 48 x 168 x 29	(4) 6" Panel Legs	CTPB48168RT	\$4,869	\$5,173	\$5,431
	* 60 x 168 x 29	(4) 6" Panel Legs	CTPB60168RT	\$5,398	\$5,721	\$5,995
BOAT ROUNDED SHAPE TOP (BR)						
	42 x 84 x 29	(2) 6" Panel Legs	CTPB4284BR	\$2,295	\$2,504	\$2,568
	42 x 96 x 29	(2) 6" Panel Legs	CTPB4296BR	\$2,510	\$2,734	\$2,803
	48 x 96 x 29	(2) 6" Panel Legs	CTPB4896BR	\$2,644	\$2,868	\$2,937
	* 48 x 120 x 29	(3) 6" Panel Legs	CTPB48120BR	\$3,388	\$3,649	\$3,871
	* 60 x 120 x 29	(3) 6" Panel Legs	CTPB60120BR	\$3,773	\$4,054	\$4,291
	* 48 x 144 x 29	(3) 6" Panel Legs	CTPB48144BR	\$4,232	\$4,531	\$4,784
	* 60 x 144 x 29	(3) 6" Panel Legs	CTPB60144BR	\$4,728	\$5,046	\$5,315
	* 48 x 168 x 29	(4) 6" Panel Legs	CTPB48168BR	\$4,869	\$5,203	\$5,485
	* 60 x 168 x 29	(4) 6" Panel Legs	CTPB60168BR	\$5,398	\$5,753	\$6,054
OVAL SHAPE TOP (OV)						
	42 x 84 x 29	(2) 6" Panel Legs	CTPB4284OV	\$2,295	\$2,452	\$2,501
	42 x 96 x 29	(2) 6" Panel Legs	CTPB4296OV	\$2,510	\$2,686	\$2,740
	48 x 96 x 29	(2) 6" Panel Legs	CTPB4896OV	\$2,644	\$2,825	\$2,881
	* 48 x 120 x 29	(3) 6" Panel Legs	CTPB48120OV	\$3,388	\$3,604	\$3,786
	* 60 x 120 x 29	(3) 6" Panel Legs	CTPB60120OV	\$3,773	\$3,998	\$4,189
	* 48 x 144 x 29	(3) 6" Panel Legs	CTPB48144OV	\$4,232	\$4,482	\$4,693
	* 60 x 144 x 29	(3) 6" Panel Legs	CTPB60144OV	\$4,728	\$4,997	\$5,224
	* 48 x 168 x 29	(4) 6" Panel Legs	CTPB48168OV	\$4,869	\$5,193	\$5,468
	* 60 x 168 x 29	(4) 6" Panel Legs	CTPB60168OV	\$5,398	\$5,742	\$6,032



STUDIO SERIES

STUDIO PANEL SERIES | 29", 36", 42" HEIGHTS | OVERVIEW



Studio tables effectively perform in conference, hoteling, collaboration, or touch-down applications in standing, counter, and seated heights.

Sizes | 29", 36", 42" HEIGHTS (OTHER SIZES AVAILABLE. UPCHARGES APPLY. CONSULT FACTORY FOR PRICING.)

- Table Depths (width): 24", 30", 36", 42" & 48"
- Table Lengths:
60", 72", 84", 96" = 1 Piece Tops
108", 120", 132", 144" = 2 Piece Tops*

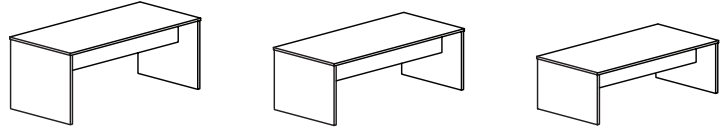

Surface Specifications | RECTANGLE SHAPES

- 44 Standard HPL Finishes
- 3 Edge Options in Matching & Coordinating Finishes
- Top Thickness 1-¼" (+/- based on edge detail)
- Tables 108" & Longer Have 2 Piece Tops with a Shallow Center Leg*

Note: Center Leg is 12" Deep on 24" & 30" Tables, 18" Deep on Tables 36" Wide & Larger

- See "Primeway Standard Color Card" for All Finish Specifications & Swatches -

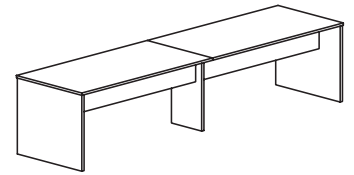

Base & Support Specifications | 12" OR 15" MODESTY PANELS

- **MODESTY PANELS | ON CENTER**
12" high for 29" height tables
15" high on 36" & 42" high tables
- **STRETCHER SUPPORT | SINGLE OR DOUBLE**

Tables at 24" deep have 1 stretcher support centered on the depth.

Note: Stretcher support can be placed at a 2" offset from one long edge, but must be specified on order.

Center support leg is also offset towards one long edge to coincide when offset support option is required.

Tables 30" deep or more have 2 stretcher supports.

Note: Supports are inset 11" from the long edges of the top on 30" deep tables & 14" from the edges on tables over 30".

- Adjustable leveling glides included.
- All tables ship K.D. & require simple assembly on site. Be sure to check ingress to space (elevator?) for large tops.

Accessories | ROUND GROMMET, HOOK & POWER/DATA OPTIONS AVAILABLE, INCLUDING UNDER MOUNT EDGE POWER*

Model#	Accessory Options	List Price
TFG	Round Grommet (3" Black Plastic)	\$25
UBH	Black Hook, Under Mount (near edge)	\$35

SPECIFY EXACT LOCATION FOR ANY ABOVE OPTION



Model#	Optional Features	ADD TO List Price
WMAP	Wire Management Access Panel	\$413

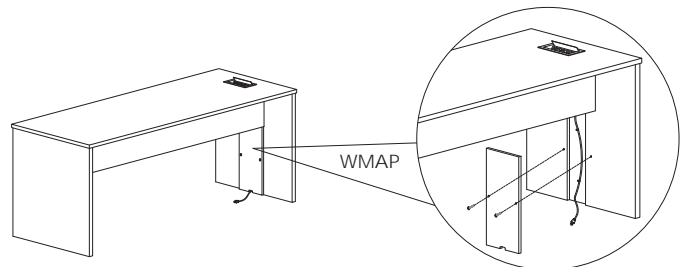

*For full details, see the Accessories & Power/Data sections at the front of this guide.

When routing PPD/device cords from the table surface to the floor, a wire management access panel (WMAP) can be provided. A channel is routed into the vertical end panel leg to create a wire chase & a decorative overlay panel is provided as a channel cover. Cover panel is attached with 2 decorative screws & has a small wire access slot at the bottom for cord passage. Cable ties are provided for securing cords inside the channel.



HPL TOPS | 44 standard HPL finishes

EDGES | matching & coordinating finishes in the following options:

ABS 1: PVC-free impact resistant flat edge (S)

ABS 2: Multi-Ply "Plywood Look" flat vinyl edge (M)

- Refer to edge code, above in (), when pricing below -

(*) Refers to a 2-Piece Top & narrow center leg. Spline and Joint Fasteners included with table.

NOTE: Woodgrain pattern alignment between two tops not guaranteed.



SIZE W x L x H	BASE INFO Stretcher #	MODEL #	ABS 1 S	ABS 2 M	
SEATED HEIGHT TABLES - 29" H WITH 12" CENTER MODESTY PANEL					
	24 x 60 x 29	Single	CSTS246029	\$905	\$1,223
	24 x 72 x 29	Single	CSTS247229	\$964	\$1,309
	24 x 84 x 29	Single	CSTS248429	\$1,260	\$1,631
	24 x 96 x 29	Single	CSTS249629	\$1,260	\$1,658
	* 24 x 108 x 29	Single	CSTS2410829	\$1,510	\$2,000
	* 24 x 120 x 29	Single	CSTS2412029	\$1,510	\$2,027
	* 24 x 132 x 29	Single	CSTS2413229	\$1,620	\$2,163
	* 24 x 144 x 29	Single	CSTS2414429	\$1,620	\$2,177
	30 x 60 x 29	Double Stretcher Support	CSTS306029	\$1,206	\$1,537
	30 x 72 x 29	Double Stretcher Support	CSTS307229	\$1,274	\$1,632
	30 x 84 x 29	Double Stretcher Support	CSTS308429	\$1,510	\$1,894
	30 x 96 x 29	Double Stretcher Support	CSTS309629	\$1,510	\$1,921
	* 30 x 108 x 29	Double Stretcher Support	CSTS3010829	\$2,046	\$2,550
	* 30 x 120 x 29	Double Stretcher Support	CSTS3012029	\$2,046	\$2,576
	* 30 x 132 x 29	Double Stretcher Support	CSTS3013229	\$2,248	\$2,805
	* 30 x 144 x 29	Double Stretcher Support	CSTS3014429	\$2,248	\$2,831
	36 x 60 x 29	Double Stretcher Support	CSTS366029	\$1,390	\$1,735
	36 x 72 x 29	Double Stretcher Support	CSTS367229	\$1,494	\$1,865
	36 x 84 x 29	Double Stretcher Support	CSTS368429	\$1,738	\$2,136
	36 x 96 x 29	Double Stretcher Support	CSTS369629	\$1,738	\$2,162
	* 36 x 108 x 29	Double Stretcher Support	CSTS3610829	\$2,484	\$3,001
	* 36 x 120 x 29	Double Stretcher Support	CSTS3612029	\$2,484	\$3,027
	* 36 x 132 x 29	Double Stretcher Support	CSTS3613229	\$2,744	\$3,314
	* 36 x 144 x 29	Double Stretcher Support	CSTS3614429	\$2,744	\$3,340
	42 x 60 x 29	Double Stretcher Support	CSTS426029	\$1,720	\$2,078
	42 x 72 x 29	Double Stretcher Support	CSTS427229	\$1,863	\$2,247
	42 x 84 x 29	Double Stretcher Support	CSTS428429	\$2,056	\$2,466
	42 x 96 x 29	Double Stretcher Support	CSTS429629	\$2,056	\$2,493
	* 42 x 108 x 29	Double Stretcher Support	CSTS4210829	\$2,832	\$3,362
	* 42 x 120 x 29	Double Stretcher Support	CSTS4212029	\$2,832	\$3,389
	* 42 x 132 x 29	Double Stretcher Support	CSTS4213229	\$3,110	\$3,693
	* 42 x 144 x 29	Double Stretcher Support	CSTS4214429	\$3,110	\$3,720
	48 x 60 x 29	Double Stretcher Support	CSTS486029	\$1,545	\$1,916
	48 x 72 x 29	Double Stretcher Support	CSTS487229	\$2,106	\$2,503
	48 x 84 x 29	Double Stretcher Support	CSTS488429	\$2,306	\$2,730
	48 x 96 x 29	Double Stretcher Support	CSTS489629	\$2,306	\$2,757
	* 48 x 108 x 29	Double Stretcher Support	CSTS4810829	\$2,885	\$3,428
	* 48 x 120 x 29	Double Stretcher Support	CSTS4812029	\$2,885	\$3,455
	* 48 x 132 x 29	Double Stretcher Support	CSTS4813229	\$3,146	\$3,742
	* 48 x 144 x 29	Double Stretcher Support	CSTS4814429	\$3,146	\$3,769



HPL TOPS | 44 standard HPL finishes

EDGES | matching & coordinating finishes in the following options:

ABS 1: PVC-free impact resistant flat edge (S)











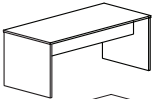
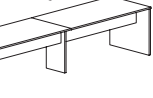
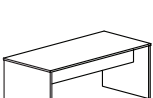
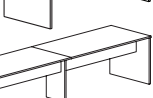
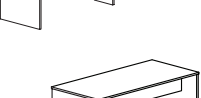
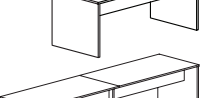

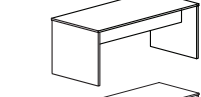
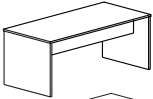
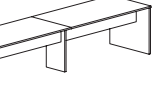
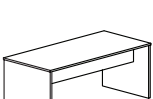
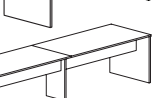
ABS 2: Multi-Ply "Plywood Look" flat vinyl edge (M)

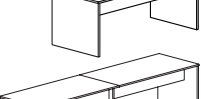
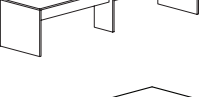
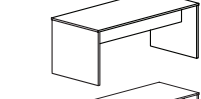
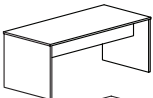
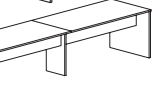
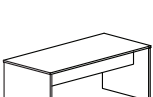
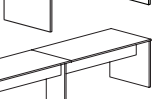
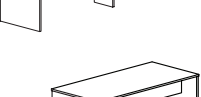
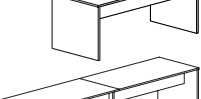
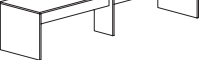
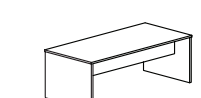
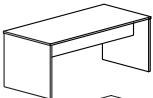
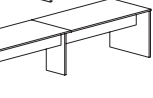
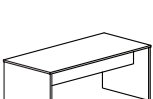
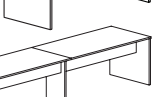
- Refer to edge code, above in (), when pricing below -

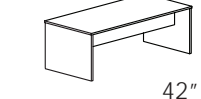
(*) Refers to a 2-Piece Top & narrow center leg. Spline and Joint Fasteners included with table.

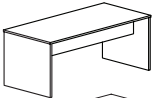
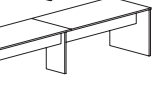
NOTE: Woodgrain pattern alignment between two tops not guaranteed.



SIZE W x L x H	BASE INFO Stretcher #	MODEL #	ABS 1 S	ABS 2 M
STANDING HEIGHT TABLES - 42" H WITH 15" CENTER MODESTY PANEL				
	24 x 60 x 42 Single	CSTS246042	\$1,090	\$1,461
	24 x 72 x 42 Single	CSTS247242	\$1,119	\$1,517
	24 x 84 x 42 Single	CSTS248442	\$1,415	\$1,839
	24 x 96 x 42 Single	CSTS249642	\$1,415	\$1,866
	* 24 x 108 x 42 Single	CSTS2410842	\$1,690	\$2,233
	* 24 x 120 x 42 Single	CSTS2412042	\$1,690	\$2,260
	* 24 x 132 x 42 Single	CSTS2413242	\$1,800	\$2,396
	* 24 x 144 x 42 Single	CSTS2414442	\$1,800	\$2,423
	30 x 60 x 42 Double Stretcher Support	CSTS306042	\$1,376	\$1,760
	30 x 72 x 42 Double Stretcher Support	CSTS307242	\$1,444	\$1,855
	30 x 84 x 42 Double Stretcher Support	CSTS308442	\$1,680	\$2,117
	30 x 96 x 42 Double Stretcher Support	CSTS309642	\$1,720	\$2,184
	* 30 x 108 x 42 Double Stretcher Support	CSTS3010842	\$2,256	\$2,813
	* 30 x 120 x 42 Double Stretcher Support	CSTS3012042	\$2,256	\$2,839
	* 30 x 132 x 42 Double Stretcher Support	CSTS3013242	\$2,458	\$3,068
	* 30 x 144 x 42 Double Stretcher Support	CSTS3014442	\$2,458	\$3,094
	36 x 60 x 42 Double Stretcher Support	CSTS366042	\$1,585	\$1,983
	36 x 72 x 42 Double Stretcher Support	CSTS367242	\$1,689	\$2,113
	36 x 84 x 42 Double Stretcher Support	CSTS368442	\$1,933	\$2,384
	36 x 96 x 42 Double Stretcher Support	CSTS369642	\$1,933	\$2,410
	* 36 x 108 x 42 Double Stretcher Support	CSTS3610842	\$2,939	\$3,509
	* 36 x 120 x 42 Double Stretcher Support	CSTS3612042	\$2,939	\$3,535
	* 36 x 132 x 42 Double Stretcher Support	CSTS3613242	\$3,224	\$3,847
	* 36 x 144 x 42 Double Stretcher Support	CSTS3614442	\$3,224	\$3,873
	42 x 60 x 42 Double Stretcher Support	CSTS426042	\$2,055	\$2,466
	42 x 72 x 42 Double Stretcher Support	CSTS427242	\$2,198	\$2,635
	42 x 84 x 42 Double Stretcher Support	CSTS428442	\$2,391	\$2,854
	42 x 96 x 42 Double Stretcher Support	CSTS429642	\$2,391	\$2,881
	* 42 x 108 x 42 Double Stretcher Support	CSTS4210842	\$3,342	\$3,925
	* 42 x 120 x 42 Double Stretcher Support	CSTS4212042	\$3,342	\$3,952
	* 42 x 132 x 42 Double Stretcher Support	CSTS4213242	\$3,620	\$4,256
	* 42 x 144 x 42 Double Stretcher Support	CSTS4214442	\$3,620	\$4,283
	48 x 60 x 42 Double Stretcher Support	CSTS486042	\$1,880	\$2,304
	48 x 72 x 42 Double Stretcher Support	CSTS487242	\$2,441	\$2,891
	48 x 84 x 42 Double Stretcher Support	CSTS488442	\$2,641	\$3,118
	48 x 96 x 42 Double Stretcher Support	CSTS489642	\$2,641	\$3,145
	* 48 x 108 x 42 Double Stretcher Support	CSTS4810842	\$3,395	\$3,991
	* 48 x 120 x 42 Double Stretcher Support	CSTS4812042	\$3,395	\$4,018
	* 48 x 132 x 42 Double Stretcher Support	CSTS4813242	\$3,656	\$4,305
	* 48 x 144 x 42 Double Stretcher Support	CSTS4814442	\$3,656	\$4,332

COUNTER HEIGHT TABLES - 36" H WITH 15" H CENTER MODESTY PANEL | Use 42" H Model #'s & CHANGE LAST 2 DIGITS TO "36" & ADJUST PRICING AS FOLLOWS:

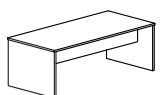

- 24" Wide: Deduct \$45.00 List from 42" H Price / model # example: 24" x 96" x 36" = CSTS249636
- 30" Wide: Deduct \$60.00 List from 42" H Price / model # example: 30" x 96" x 36" = CSTS309636
- 36" Wide: Deduct \$75.00 List from 42" H Price / model # example: 36" x 96" x 36" = CSTS369636
- 42" or 48" Wide: Deduct \$100.00 List from 42" H Price / model # example: 48" x 96" x 36" = CSTS489636



HPL TOPS | 44 standard HPL finishes

METAL BASES | 11 powder coat finishes

EDGES | matching & coordinating finishes in the following options:

ABS 1: PVC-free impact resistant flat edge (S)

ABS 2: Multi-Ply "Plywood Look" flat vinyl edge (M)

ABS 3: Knife (KV), 1/2" Flat edge- bevel painted in a companion color

- Refer to edge code, above in (), when pricing below -

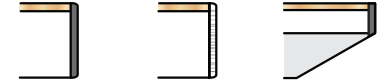

Standard Features:

- Adjustable leveling glides included.
- Power/Data options available, see Power/Data Solutions page.
- Wire management, grommets, etc. available, consult factory.

SIZE	BASE INFO #, Style	MODEL #	ABS 1 S	ABS 2 M	ABS 3 KV	
SEATED HEIGHT TABLES - 29" H.						
	42 x 72 x 29	(2) A-Frame Bases	CSA427229	\$2,695	\$2,873	\$2,966
	42 x 84 x 29	(2) A-Frame Bases	CSA428429	\$2,811	\$3,237	\$3,354
	42 x 96 x 29	(2) A-Frame Bases	CSA429629	\$3,051	\$3,366	\$3,630
	* 42 x 120 x 29	(3) A-Frame Bases	CSA4212029	\$3,468	\$5,190	\$5,697
	48 x 72 x 29	(2) A-Frame Bases	CSA487229	\$2,879	\$3,301	\$3,521
	48 x 84 x 29	(2) A-Frame Bases	CSA488429	\$3,129	\$3,489	\$3,709
	48 x 96 x 29	(2) A-Frame Bases	CSA489629	\$3,381	\$3,538	\$3,763
	* 48 x 120 x 29	(3) A-Frame Bases	CSA4812029	\$4,271	\$5,326	\$5,851
STANDING HEIGHT TABLES - 42" H.						
	42 x 72 x 42	(2) A-Frame Bases	CSA427242	\$3,025	\$3,203	\$3,297
	42 x 84 x 42	(2) A-Frame Bases	CSA428442	\$3,294	\$3,332	\$3,447
	42 x 96 x 42	(2) A-Frame Bases	CSA429642	\$3,400	\$3,459	\$3,722
	* 42 x 120 x 42	(3) A-Frame Bases	CSA4212042	\$4,036	\$5,334	\$5,840
	48 x 72 x 42	(2) A-Frame Bases	CSA487242	\$3,362	\$3,521	\$3,644
	48 x 84 x 42	(2) A-Frame Bases	CSA488442	\$3,394	\$3,583	\$3,803
	48 x 96 x 42	(2) A-Frame Bases	CSA489642	\$3,670	\$3,883	\$4,088
	* 48 x 120 x 42	(3) A-Frame Bases	CSA4812042	\$4,415	\$5,470	\$5,995
	(*) Refers to a 2-Piece Top & 3 legs. Spline and Joint Fasteners included with table.					
	NOTE: Woodgrain pattern alignment between two tops not guaranteed.					



MADISON SERIES



Standard Features:

- Adjustable leveling glides included.
- Power/Data options available, consult factory.
- For additional base options (casters, flip top, etc.), consult factory.

HPL TOPS | 44 standard HPL finishes

METAL BASES | 11 powder coat finishes

EDGES | matching & coordinating finishes in the following options:

ABS 1: PVC-free impact resistant flat edge (S)

ABS 2: Multi-Ply "Plywood Look" flat vinyl edge (M)

ABS 3: Knife (KV), 1/2" Flat edge- bevel painted in a companion color

- Refer to edge code, above in (), when pricing below -

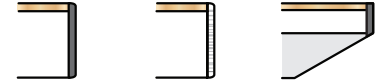

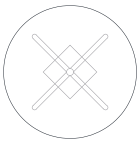
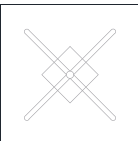
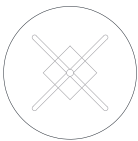
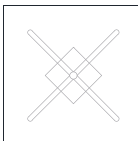
SIZE	BASE INFO #, Style	MODEL #	ABS 1 S	ABS 2 M	ABS 3 KV	
ROUND TOP CAFE HEIGHT 42" H.						
	24" Dia. x 42	(1) X-Base	TMRX2442	\$583	\$639	\$657
	30" Dia. x 42	(1) X-Base	TMRX3042	\$655	\$726	\$748
	36" Dia. x 42	(1) X-Base	TMRX3642	\$802	\$888	\$914
	42" Dia. x 42	(1) X-Base	TMRX4242	\$898	\$998	\$1,029
	48" Dia. x 42	(1) X-Base	TMRX4842	\$987	\$1,102	\$1,137
	54" Dia. x 42	(1) X-Base	TMRX5442	\$1,099	\$1,227	\$1,267
SQUARE TOP CAFE HEIGHT 42" H.						
	24 x 24 x 42	(1) X-Base	TMSX2442	\$583	\$655	\$678
	30 x 30 x 42	(1) X-Base	TMSX3042	\$655	\$746	\$774
	36 x 36 x 42	(1) X-Base	TMSX3642	\$802	\$911	\$945
	42 x 42 x 42	(1) X-Base	TMSX4242	\$898	\$1,025	\$1,064
	48 x 48 x 42	(1) X-Base	TMSX4842	\$987	\$1,133	\$1,178
	54 x 54 x 42	(1) X-Base	TMSX5442	\$1,099	\$1,263	\$1,401
ROUND TOP CAFE HEIGHT 29" H.						
	24" Dia. x 29	(1) X-Base	TMRX2429	\$557	\$614	\$631
	30" Dia. x 29	(1) X-Base	TMRX3029	\$627	\$698	\$720
	36" Dia. x 29	(1) X-Base	TMRX3629	\$692	\$777	\$804
	42" Dia. x 29	(1) X-Base	TMRX4229	\$834	\$934	\$965
	48" Dia. x 29	(1) X-Base	TMRX4829	\$926	\$1,040	\$1,075
	54" Dia. x 29	(1) X-Base	TMRX5429	\$1,045	\$1,173	\$1,213
SQUARE TOP SEATED HEIGHT 29" H.						
	24 x 24 x 29	(1) X-Base	TMSX2429	\$557	\$630	\$652
	30 x 30 x 29	(1) X-Base	TMSX3029	\$627	\$718	\$746
	36 x 36 x 29	(1) X-Base	TMSX3629	\$692	\$801	\$834
	42 x 42 x 29	(1) X-Base	TMSX4229	\$834	\$961	\$1,001
	48 x 48 x 29	(1) X-Base	TMSX4829	\$926	\$1,072	\$1,116
	54 x 54 x 29	(1) X-Base	TMSX5429	\$1,045	\$1,209	\$1,347



HPL TOPS | 44 standard HPL finishes

METAL BASES | 11 powder coat finishes

EDGES | matching & coordinating finishes in the following options:

ABS 1: PVC-free impact resistant flat edge (S)

ABS 2: Multi-Ply "Plywood Look" flat vinyl edge (M)

ABS 3: Knife (KV), 1/2" Flat edge- bevel painted in a companion color

- Refer to edge code, above in (), when pricing below -

Standard Features:

- Adjustable leveling glides included.
- Power/Data options available, see Power/Data Solutions page.
- For additional base options (casters, flip top, folding, etc.), consult factory.

NOTE: See next page for "Mobile Flip Top" Tables.

- Modesty panel, wire management, grommets, etc. available, consult factory.

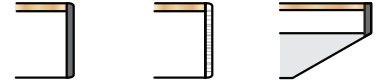

SIZE	BASE INFO #, Style	MODEL #	ABS 1 S	ABS 2 M	ABS 3 KV	
RECTANGULAR TABLES						
	18 x 42 x 29	(2) T-Base	TM1842	\$586	\$677	\$705
	18 x 48 x 29	(2) T-Base	TM1848	\$617	\$717	\$748
	18 x 60 x 29	(2) T-Base	TM1860	\$737	\$855	\$892
	18 x 72 x 29	(2) T-Base	TM1872	\$781	\$918	\$960
	18 x 84 x 29	(2) T-Base	TM1884	\$850	\$1,005	\$1,052
	18 x 96 x 29	(2) T-Base	TM1896	\$892	\$1,064	\$1,118
	20 x 42 x 29	(2) T-Base	TM2042	\$314	\$408	\$437
	20 x 48 x 29	(2) T-Base	TM2048	\$665	\$768	\$800
	20 x 60 x 29	(2) T-Base	TM2060	\$782	\$904	\$941
	20 x 72 x 29	(2) T-Base	TM2072	\$828	\$967	\$1,010
20 x 84 x 29	(2) T-Base	TM2084	\$903	\$1,060	\$1,109	
20 x 96 x 29	(2) T-Base	TM2096	\$947	\$1,123	\$1,177	
24 x 42 x 29	(2) T-Base	TM2442	\$652	\$753	\$783	
24 x 48 x 29	(2) T-Base	TM2448	\$671	\$780	\$814	
24 x 60 x 29	(2) T-Base	TM2460	\$749	\$877	\$916	
24 x 72 x 29	(2) T-Base	TM2472	\$810	\$956	\$1,001	
24 x 84 x 29	(2) T-Base	TM2484	\$953	\$1,117	\$1,167	
24 x 96 x 29	(2) T-Base	TM2496	\$1,000	\$1,182	\$1,238	
30 x 42 x 29	(2) T-Base	TM3042	\$773	\$882	\$915	
30 x 48 x 29	(2) T-Base	TM3048	\$793	\$912	\$948	
30 x 60 x 29	(2) T-Base	TM3060	\$875	\$1,011	\$1,053	
30 x 72 x 29	(2) T-Base	TM3072	\$933	\$1,087	\$1,135	
30 x 84 x 29	(2) T-Base	TM3084	\$1,065	\$1,237	\$1,291	
30 x 96 x 29	(2) T-Base	TM3096	\$1,099	\$1,290	\$1,349	
36 x 42 x 29	(2) T-Base	TM3642	\$835	\$953	\$990	
36 x 48 x 29	(2) T-Base	TM3648	\$863	\$991	\$1,030	
36 x 60 x 29	(2) T-Base	TM3660	\$996	\$1,141	\$1,186	
36 x 72 x 29	(2) T-Base	TM3672	\$1,072	\$1,236	\$1,286	
36 x 84 x 29	(2) T-Base	TM3684	\$1,148	\$1,330	\$1,386	
36 x 96 x 29	(2) T-Base	TM3696	\$1,199	\$1,400	\$1,461	

VIDEO CONFERENCE SHAPE TABLES

THE VIDEO CONFERRING SHAPE (-VC) CAN BE USED TO CREATE MANY CONFIGURATIONS, (BELOW LEFT)
OVERALL SIZE OF TABLE (D X W) LISTED IS NOMINAL AND MAY VARY +/- 1/2"

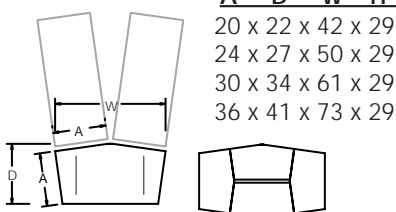

A	D	W	H	BASE INFO #, Style	MODEL #	ABS 1 S	ABS 2 M	ABS 3 KV	
	20	22	42	29	(2) T-Base	TM2242-VC	\$818	\$911	\$939
	24	27	50	29	(2) T-Base	TM2750-VC	\$947	\$1,057	\$939
	30	34	61	29	(2) T-Base	TM3461-VC	\$1,163	\$1,300	\$1,092
	36	41	73	29	(2) T-Base	TM4173-VC	\$1,320	\$1,484	\$1,342

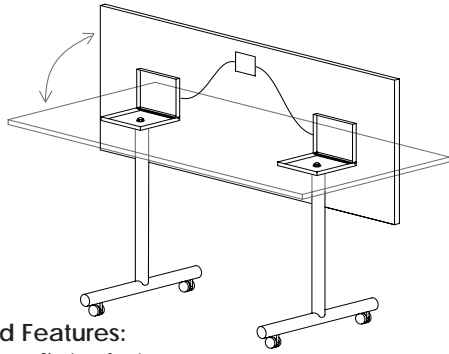

Standard Features:

- Single lever flip top feature.
- 2" Locking casters included. (Specify for hard floor or carpeted areas)
- Power/Data options available, see Power/Data Solutions page.
- Modesty panel, wire management, grommets, etc. available, consult factory.

HPL TOPS | 44 standard HPL finishes

METAL BASES | 11 powder coat finishes

EDGES | matching & coordinating finishes in the following options:

ABS 1: PVC-free impact resistant flat edge (S)

ABS 2: Multi-Ply "Plywood Look" flat vinyl edge (M)

ABS 3: Knife (KV), 1/2" Flat edge- bevel painted in a companion color

- Refer to edge code, above in (), when pricing below -

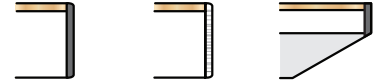

SIZE	BASE INFO #, Style	MODEL #	ABS 1	ABS 2	ABS 3	
			S	M	KV	
RECTANGULAR TABLES WITH FLIP TOP MECHANISM						
	18 x 42 x 29	(2) T-Base	TM1842-FL	\$1,001	\$1,092	\$1,120
	18 x 48 x 29	(2) T-Base	TM1848-FL	\$1,031	\$1,131	\$1,162
	18 x 60 x 29	(2) T-Base	TM1860-FL	\$1,151	\$1,270	\$1,306
	18 x 72 x 29	(2) T-Base	TM1872-FL	\$1,196	\$1,332	\$1,374
	18 x 84 x 29	(2) T-Base	TM1884-FL	\$1,264	\$1,419	\$1,467
	18 x 96 x 29	(2) T-Base	TM1896-FL	\$1,306	\$1,479	\$1,532
	20 x 42 x 29	(2) T-Base	TM2042-FL	\$728	\$822	\$851
	20 x 48 x 29	(2) T-Base	TM2048-FL	\$1,079	\$1,182	\$1,214
	20 x 60 x 29	(2) T-Base	TM2060-FL	\$1,197	\$1,318	\$1,356
	20 x 72 x 29	(2) T-Base	TM2072-FL	\$1,242	\$1,382	\$1,425
	20 x 84 x 29	(2) T-Base	TM2084-FL	\$1,317	\$1,475	\$1,523
	20 x 96 x 29	(2) T-Base	TM2096-FL	\$1,361	\$1,537	\$1,591
24 x 42 x 29	(2) T-Base	TM2442-FL	\$1,067	\$1,167	\$1,198	
24 x 48 x 29	(2) T-Base	TM2448-FL	\$1,085	\$1,194	\$1,228	
24 x 60 x 29	(2) T-Base	TM2460-FL	\$1,164	\$1,291	\$1,330	
24 x 72 x 29	(2) T-Base	TM2472-FL	\$1,225	\$1,370	\$1,415	
24 x 84 x 29	(2) T-Base	TM2484-FL	\$1,367	\$1,531	\$1,582	
24 x 96 x 29	(2) T-Base	TM2496-FL	\$1,414	\$1,596	\$1,652	
30 x 42 x 29	(2) T-Base	TM3042-FL	\$1,187	\$1,296	\$1,330	
30 x 48 x 29	(2) T-Base	TM3048-FL	\$1,208	\$1,326	\$1,363	
30 x 60 x 29	(2) T-Base	TM3060-FL	\$1,289	\$1,426	\$1,468	
30 x 72 x 29	(2) T-Base	TM3072-FL	\$1,347	\$1,502	\$1,549	
30 x 84 x 29	(2) T-Base	TM3084-FL	\$1,479	\$1,652	\$1,705	
30 x 96 x 29	(2) T-Base	TM3096-FL	\$1,513	\$1,704	\$1,763	
36 x 42 x 29	(2) T-Base	TM3642-FL	\$1,250	\$1,368	\$1,404	
36 x 48 x 29	(2) T-Base	TM3648-FL	\$1,278	\$1,405	\$1,444	
36 x 60 x 29	(2) T-Base	TM3660-FL	\$1,410	\$1,556	\$1,601	
36 x 72 x 29	(2) T-Base	TM3672-FL	\$1,486	\$1,650	\$1,700	
36 x 84 x 29	(2) T-Base	TM3684-FL	\$1,562	\$1,744	\$1,800	
36 x 96 x 29	(2) T-Base	TM3696-FL	\$1,614	\$1,814	\$1,876	

VIDEO CONFERENCE SHAPE TABLES WITH FLIP TOP MECHANISM THE VIDEO CONFERENCING SHAPE (-VC) CAN BE USED TO CREATE MANY CONFIGURATIONS (BELOW LEFT)
OVERALL SIZE OF TABLE (D X W) LISTED IS NOMINAL AND MAY VARY +/- 1/2"

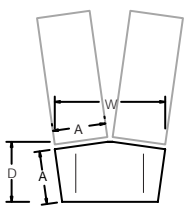

A	D	W	H					
20	22	42	29	(2) T-Base	TM2242-VC-FL	\$1,232	\$1,325	\$1,353
24	27	50	29	(2) T-Base	TM2750-VC-FL	\$1,361	\$1,472	\$1,506
30	34	61	29	(2) T-Base	TM3461-VC-FL	\$1,577	\$1,714	\$1,757
36	41	73	29	(2) T-Base	TM4173-VC-FL	\$1,734	\$1,899	\$1,949

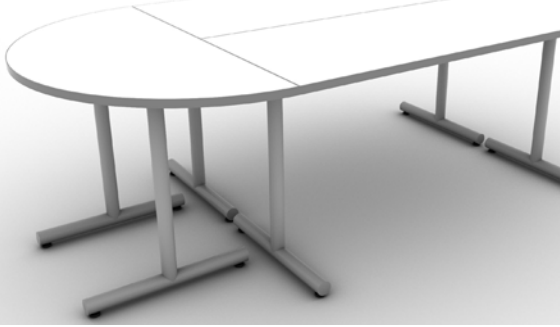

HPL TOPS | 44 standard HPL finishes

METAL BASES | 11 powder coat finishes

EDGES | matching & coordinating finishes in the following options:

ABS 1: PVC-free impact resistant flat edge (S)

ABS 2: Multi-Ply "Plywood Look" flat vinyl edge (M)



ABS 3: Knife (KV), 1/2" Flat edge- bevel painted in a companion color

- Refer to edge code, above in (), when pricing below -

Standard Features:

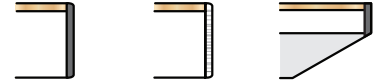
- Adjustable leveling glides included.
- Power/Data options available, consult factory.
- For additional base options (casters, flip top, etc.), consult factory.

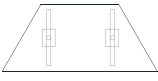
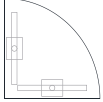

	SIZE	BASE INFO #, Style	MODEL #	ABS 1 S	ABS 2 M	ABS 3 KV
HALF ROUND						
	18 x 36 x 29	(2) T-Base	TMHR1836	\$648	\$718	\$739
	20 x 40 x 29	(2) T-Base	TMHR2040	\$725	\$803	\$827
	24 x 48 x 29	(2) T-Base	TMHR2448	\$774	\$867	\$896
	30 x 60 x 29	(2) T-Base	TMHR3060	\$926	\$1,043	\$1,079
	36 x 72 x 29	(2) T-Base	TMHR3672	\$1,179	\$1,319	\$1,362
CRESCENT						
	18 x 48 x 29	(2) T-Base	TMCR1848	\$1,083	\$1,183	\$1,214
	18 x 60 x 29	(2) T-Base	TMCR1860	\$1,250	\$1,368	\$1,404
	24 x 48 x 29	(2) T-Base	TMCR2448	\$1,185	\$1,294	\$1,328
	24 x 60 x 29	(2) T-Base	TMCR2460	\$1,356	\$1,484	\$1,523
	30 x 48 x 29	(2) T-Base	TMCR3048	\$1,236	\$1,355	\$1,391
	30 x 60 x 29	(2) T-Base	TMCR3060	\$1,473	\$1,609	\$1,651
TRAPEZOID						
	24 x 48 x 29	(2) T-Base	TMTR2448	\$776	\$886	\$919
	24 x 60 x 29	(2) T-Base	TMTR2460	\$845	\$972	\$1,012
	24 x 72 x 29	(2) T-Base	TMTR2472	\$982	\$1,128	\$1,173
	30 x 48 x 29	(2) T-Base	TMTR3048	\$851	\$969	\$1,006
	30 x 60 x 29	(2) T-Base	TMTR3060	\$922	\$1,059	\$1,101
	30 x 72 x 29	(2) T-Base	TMTR3072	\$1,047	\$1,202	\$1,250
	36 x 48 x 29	(2) T-Base	TMTR3648	\$922	\$1,050	\$1,089
	36 x 60 x 29	(2) T-Base	TMTR3660	\$1,011	\$1,156	\$1,201
	36 x 72 x 29	(2) T-Base	TMTR3672	\$1,154	\$1,318	\$1,368
QUARTER ROUND						
	24 x 24 x 29	(2) T-Base	TMQR2424	\$660	\$725	\$745
	30 x 30 x 29	(2) T-Base	TMQR3030	\$743	\$824	\$849
	36 x 36 x 29	(2) T-Base	TMQR3636	\$839	\$936	\$966



HPL TOPS | 44 standard HPL finishes

METAL BASES | 11 powder coat finishes

EDGES | matching & coordinating finishes in the following options:

ABS 1: PVC-free impact resistant flat edge (S)

ABS 2: Multi-Ply "Plywood Look" flat vinyl edge (M)

ABS 3: Knife (KV), 1/2" Flat edge- bevel painted in a companion color

- Refer to edge code, above in (), when pricing below -

Standard Features:

- Adjustable leveling glides included.
- Power/Data options available, see Power/Data Solutions page.
- Wire management, grommets, etc. available, consult factory.

(*) Refers to a 2-Piece Top. Spline and Joint Fasteners included with table.

NOTE: Woodgrain pattern alignment between two tops not guaranteed.

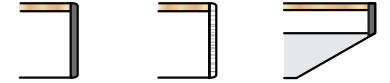

SIZE	BASE INFO #, Style	MODEL #	ABS 1 S	ABS 2 M	ABS 3 KV	
RECTANGLE SHAPE TOP (SQ)						
	42 x 84 x 29	(2) Dbl. T-Base	CM4284SQ	\$1,639	\$1,842	\$1,904
	42 x 96 x 29	(2) Dbl. T-Base	CM4296SQ	\$1,769	\$1,987	\$2,055
	48 x 96 x 29	(2) Dbl. T-Base	CM4896SQ	\$1,831	\$2,050	\$2,117
	* 48 x 120 x 29	(3) Dbl. T-Base	CM48120SQ	\$2,631	\$2,885	\$3,101
	* 60 x 120 x 29	(3) Dbl. T-Base	CM60120SQ	\$3,094	\$3,367	\$3,598
	* 48 x 144 x 29	(3) Dbl. T-Base	CM48144SQ	\$2,830	\$3,121	\$3,367
	* 60 x 144 x 29	(3) Dbl. T-Base	CM60144SQ	\$3,364	\$3,673	\$3,935
	* 48 x 168 x 29	(4) Dbl. T-Base	CM48168SQ	\$3,486	\$3,811	\$4,087
	* 60 x 168 x 29	(4) Dbl. T-Base	CM60168SQ	\$4,037	\$4,382	\$4,675
WEDGE SHAPE TOP (WD)						
	42 x 84 x 29	(2) Dbl. T-Base	CM4284WD	\$1,765	\$1,969	\$2,031
	42 x 96 x 29	(2) Dbl. T-Base	CM4296WD	\$1,916	\$2,134	\$2,201
	48 x 96 x 29	(2) Dbl. T-Base	CM4896WD	\$1,998	\$2,216	\$2,283
	* 48 x 120 x 29	(3) Dbl. T-Base	CM48120WD	\$2,839	\$3,094	\$3,310
	* 60 x 120 x 29	(3) Dbl. T-Base	CM60120WD	\$3,355	\$3,628	\$3,859
	* 48 x 144 x 29	(3) Dbl. T-Base	CM48144WD	\$3,081	\$3,372	\$3,618
	* 60 x 144 x 29	(3) Dbl. T-Base	CM60144WD	\$3,677	\$3,987	\$4,249
	* 48 x 168 x 29	(4) Dbl. T-Base	CM48168WD	\$3,779	\$4,105	\$4,380
	* 60 x 168 x 29	(4) Dbl. T-Base	CM60168WD	\$4,402	\$4,748	\$5,041
BOAT SHAPE TOP (BT)						
	42 x 84 x 29	(2) Dbl. T-Base	CM4284BT	\$1,798	\$2,001	\$2,063
	42 x 96 x 29	(2) Dbl. T-Base	CM4296BT	\$1,952	\$2,170	\$2,237
	48 x 96 x 29	(2) Dbl. T-Base	CM4896BT	\$2,040	\$2,258	\$2,326
	* 48 x 120 x 29	(3) Dbl. T-Base	CM48120BT	\$2,892	\$3,146	\$3,362
	* 60 x 120 x 29	(3) Dbl. T-Base	CM60120BT	\$3,420	\$3,693	\$3,924
	* 48 x 144 x 29	(3) Dbl. T-Base	CM48144BT	\$3,143	\$3,434	\$3,680
	* 60 x 144 x 29	(3) Dbl. T-Base	CM60144BT	\$3,756	\$4,065	\$4,327
	* 48 x 168 x 29	(4) Dbl. T-Base	CM48168BT	\$3,851	\$4,177	\$4,452
	* 60 x 168 x 29	(4) Dbl. T-Base	CM60168BT	\$4,494	\$4,840	\$5,133



HPL TOPS | 44 standard HPL finishes

METAL BASES | 11 powder coat finishes

EDGES | matching & coordinating finishes in the following options:

ABS 1: PVC-free impact resistant flat edge (S)

ABS 2: Multi-Ply "Plywood Look" flat vinyl edge (M)

ABS 3: Knife (KV), 1/2" Flat edge- bevel painted in a companion color

- Refer to edge code, above in (), when pricing below -

Standard Features:

- Adjustable leveling glides included.
- Power/Data options available, see Power/Data Solutions page.
- Wire management, grommets, etc. available, consult factory.

(*) Refers to a 2-Piece Top. Spline and Joint Fasteners included with table.

NOTE: Woodgrain pattern alignment between two tops not guaranteed.



SIZE	BASE INFO #, Style	MODEL #	ABS 1 S	ABS 2 M	ABS 3 KV	
DIAMOND SHAPE TOP (DM)						
	42 x 84 x 29	(2) Dbl. T-Base	CM4284DM	\$1,798	\$2,001	\$2,063
	42 x 96 x 29	(2) Dbl. T-Base	CM4296DM	\$1,952	\$2,170	\$2,237
	48 x 96 x 29	(2) Dbl. T-Base	CM4896DM	\$2,040	\$2,258	\$2,326
	* 48 x 120 x 29	(3) Dbl. T-Base	CM48120DM	\$2,892	\$3,146	\$3,362
	* 60 x 120 x 29	(3) Dbl. T-Base	CM60120DM	\$3,420	\$3,693	\$3,924
	* 48 x 144 x 29	(3) Dbl. T-Base	CM48144DM	\$3,143	\$3,434	\$3,680
	* 60 x 144 x 29	(3) Dbl. T-Base	CM60144DM	\$3,756	\$4,065	\$4,327
	* 48 x 168 x 29	(4) Dbl. T-Base	CM48168DM	\$3,851	\$4,177	\$4,452
	* 60 x 168 x 29	(4) Dbl. T-Base	CM60168DM	\$4,494	\$4,840	\$5,133
BULLET SHAPE TOP (BU)						
	42 x 84 x 29	(2) Dbl. T-Base	CM4284BU	\$1,798	\$1,975	\$2,030
	42 x 96 x 29	(2) Dbl. T-Base	CM4296BU	\$1,952	\$2,147	\$2,208
	48 x 96 x 29	(2) Dbl. T-Base	CM4896BU	\$2,040	\$2,243	\$2,306
	* 48 x 120 x 29	(3) Dbl. T-Base	CM48120BU	\$2,892	\$3,131	\$3,334
	* 60 x 120 x 29	(3) Dbl. T-Base	CM60120BU	\$3,420	\$3,678	\$3,896
	* 48 x 144 x 29	(3) Dbl. T-Base	CM48144BU	\$3,143	\$3,419	\$3,652
	* 60 x 144 x 29	(3) Dbl. T-Base	CM60144BU	\$3,756	\$4,050	\$4,299
	* 48 x 168 x 29	(4) Dbl. T-Base	CM48168BU	\$3,851	\$4,164	\$4,428
	* 60 x 168 x 29	(4) Dbl. T-Base	CM60168BU	\$4,494	\$4,825	\$5,105
BOW END SHAPE TOP (BE)						
	42 x 84 x 29	(2) Dbl. T-Base	CM4284BE	\$1,798	\$2,001	\$2,063
	42 x 96 x 29	(2) Dbl. T-Base	CM4296BE	\$1,952	\$2,170	\$2,237
	48 x 96 x 29	(2) Dbl. T-Base	CM4896BE	\$2,040	\$2,258	\$2,326
	* 48 x 120 x 29	(3) Dbl. T-Base	CM48120BE	\$2,892	\$3,146	\$3,362
	* 60 x 120 x 29	(3) Dbl. T-Base	CM60120BE	\$3,420	\$3,693	\$3,924
	* 48 x 144 x 29	(3) Dbl. T-Base	CM48144BE	\$3,143	\$3,434	\$3,680
	* 60 x 144 x 29	(3) Dbl. T-Base	CM60144BE	\$3,756	\$4,065	\$4,327
	* 48 x 168 x 29	(4) Dbl. T-Base	CM48168BE	\$3,851	\$4,177	\$4,452
	* 60 x 168 x 29	(4) Dbl. T-Base	CM60168BE	\$4,494	\$4,840	\$5,133



HPL TOPS | 44 standard HPL finishes

METAL BASES | 11 powder coat finishes

EDGES | matching & coordinating finishes in the following options:

ABS 1: PVC-free impact resistant flat edge (S)

ABS 2: Multi-Ply "Plywood Look" flat vinyl edge (M)

ABS 3: Knife (KV), 1/2" Flat edge- bevel painted in a companion color

- Refer to edge code, above in (), when pricing below -

Standard Features:

- Adjustable leveling glides included.
- Power/Data options available, see Power/Data Solutions page.
- Wire management, grommets, etc. available, consult factory.

(*) Refers to a 2-Piece Top. Spline and Joint Fasteners included with table.

NOTE: Woodgrain pattern alignment between two tops not guaranteed.

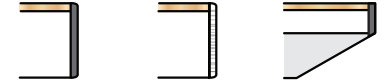

	SIZE	BASE INFO #, Style	MODEL #	ABS 1 S	ABS 2 M	ABS 3 KV
RACETRACK SHAPE TOP (RT)						
	42 x 84 x 29	(2) Dbl. T-Base	CM4284RT	\$1,815	\$1,979	\$2,029
	42 x 96 x 29	(2) Dbl. T-Base	CM4296RT	\$1,968	\$2,150	\$2,206
	48 x 96 x 29	(2) Dbl. T-Base	CM4896RT	\$2,062	\$2,251	\$2,308
	* 48 x 120 x 29	(3) Dbl. T-Base	CM48120RT	\$2,918	\$3,142	\$3,332
	* 60 x 120 x 29	(3) Dbl. T-Base	CM60120RT	\$3,452	\$3,695	\$3,900
	* 48 x 144 x 29	(3) Dbl. T-Base	CM48144RT	\$3,175	\$3,436	\$3,657
	* 60 x 144 x 29	(3) Dbl. T-Base	CM60144RT	\$3,795	\$4,075	\$4,311
	* 48 x 168 x 29	(4) Dbl. T-Base	CM48168RT	\$3,886	\$4,183	\$4,434
	* 60 x 168 x 29	(4) Dbl. T-Base	CM60168RT	\$4,539	\$4,854	\$5,120
BOAT ROUNDED SHAPE TOP (BR)						
	42 x 84 x 29	(2) Dbl. T-Base	CM4284BR	\$1,815	\$2,018	\$2,081
	42 x 96 x 29	(2) Dbl. T-Base	CM4296BR	\$1,968	\$2,186	\$2,254
	48 x 96 x 29	(2) Dbl. T-Base	CM4896BR	\$2,062	\$2,281	\$2,348
	* 48 x 120 x 29	(3) Dbl. T-Base	CM48120BR	\$2,918	\$3,173	\$3,388
	* 60 x 120 x 29	(3) Dbl. T-Base	CM60120BR	\$3,452	\$3,725	\$3,956
	* 48 x 144 x 29	(3) Dbl. T-Base	CM48144BR	\$3,175	\$3,466	\$3,713
	* 60 x 144 x 29	(3) Dbl. T-Base	CM60144BR	\$3,795	\$4,105	\$4,367
	* 48 x 168 x 29	(4) Dbl. T-Base	CM48168BR	\$3,886	\$4,212	\$4,487
	* 60 x 168 x 29	(4) Dbl. T-Base	CM60168BR	\$4,539	\$4,885	\$5,177
OVAL SHAPE TOP (OV)						
	42 x 84 x 29	(2) Dbl. T-Base	CM4284OV	\$1,815	\$1,968	\$2,015
	42 x 96 x 29	(2) Dbl. T-Base	CM4296OV	\$1,968	\$2,139	\$2,192
	48 x 96 x 29	(2) Dbl. T-Base	CM4896OV	\$2,062	\$2,239	\$2,294
	* 48 x 120 x 29	(3) Dbl. T-Base	CM48120OV	\$2,918	\$3,128	\$3,306
	* 60 x 120 x 29	(3) Dbl. T-Base	CM60120OV	\$3,452	\$3,672	\$3,857
	* 48 x 144 x 29	(3) Dbl. T-Base	CM48144OV	\$3,175	\$3,419	\$3,625
	* 60 x 144 x 29	(3) Dbl. T-Base	CM60144OV	\$3,795	\$4,057	\$4,278
	* 48 x 168 x 29	(4) Dbl. T-Base	CM48168OV	\$3,886	\$4,202	\$4,470
	* 60 x 168 x 29	(4) Dbl. T-Base	CM60168OV	\$4,539	\$4,873	\$5,156



Standard Features:

- Adjustable leveling glides included.
- Power/Data options available, see Power/Data Solutions page.
- Wire management, grommets, etc. available, consult factory.

(*) Refers to a 2-Piece Top. Spline and Joint Fasteners included with table.
 NOTE: Woodgrain pattern alignment between two tops not guaranteed.

HPL TOPS | 44 standard HPL finishes

METAL BASES | 11 powder coat finishes

EDGES | matching & coordinating finishes in the following options:

ABS 1: PVC-free impact resistant flat edge (S)

ABS 2: Multi-Ply "Plywood Look" flat vinyl edge (M)

ABS 3: Knife (KV), 1/2" Flat edge- bevel painted in a companion color

- Refer to edge code, above in (), when pricing below -

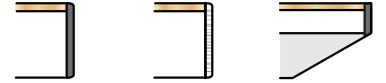

SIZE	BASE INFO #, Style	MODEL #	ABS 1 S	ABS 2 M	ABS 3 KV	
ROUND TOP SEATED HEIGHT 29"H.						
	48" Dia. x 29	(1) 4-Post X-Base	CM4829RX	\$1,225	\$1,339	\$1,375
	54" Dia. x 29	(1) 4-Post X-Base	CM5429RX	\$1,348	\$1,476	\$1,516
	60" Dia. x 29	(1) 4-Post X-Base	CM6029RX	\$1,640	\$1,783	\$1,827
	* 72" Dia. x 29	(1) 4-Post X-Base	CM7229RX	\$2,415	\$2,586	\$2,639
	* 84" Dia. x 29	(1) 4-Post X-Base	CM8429RX	\$2,846	\$3,046	\$3,108
SQUARE TOP SEATED HEIGHT 29" H.						
	48 x 48 x 29	(1) 4-Post X-Base	CM4829SX	\$1,231	\$1,377	\$1,422
	54 x 54 x 29	(1) 4-Post X-Base	CM5429SX	\$1,442	\$1,606	\$1,745
	60 x 60 x 29	(1) 4-Post X-Base	CM6029SX	\$1,542	\$1,724	\$1,878



JEFFERSON **SERIES**



HPL TOPS | 44 standard HPL finishes

METAL BASES | 11 powder coat finishes

EDGES | matching & coordinating finishes in the following options:

ABS 1: PVC-free impact resistant flat edge (S)

ABS 2: Multi-Ply "Plywood Look" flat vinyl edge (M)

ABS 3: Knife (KV), 1/2" Flat edge- bevel painted in a companion color



- Refer to edge code, above in (), when pricing below -

Standard Features:

- Power/Data options available, consult factory.
- For additional base options, consult factory.

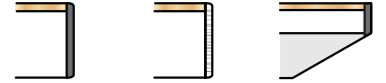
NOTE: Disc bases DO NOT come standard with adjustable leveling glides.

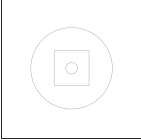

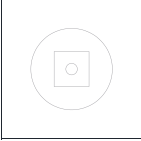
SIZE	BASE INFO #, Style	MODEL #	ABS 1 S	ABS 2 M	ABS 3 KV	
ROUND TOP CAFE HEIGHT 42" H.						
	24" Dia. x 42	(1) Disc Base	TJRD2442	\$895	\$953	\$971
	30" Dia. x 42	(1) Disc Base	TJRD3042	\$974	\$1,047	\$1,070
	36" Dia. x 42	(1) Disc Base	TJRD3642	\$1,082	\$1,170	\$1,198
	42" Dia. x 42	(1) Disc Base	TJRD4242	\$1,317	\$1,420	\$1,452
	48" Dia. x 42	(1) Disc Base	TJRD4842	\$1,380	\$1,497	\$1,533
SQUARE TOP CAFE HEIGHT 42" H.						
	24 x 24 x 42	(1) Disc Base	TJSD2442	\$895	\$970	\$993
	30 x 30 x 42	(1) Disc Base	TJSD3042	\$974	\$1,067	\$1,096
	36 x 36 x 42	(1) Disc Base	TJSD3642	\$1,082	\$1,195	\$1,229
	42 x 42 x 42	(1) Disc Base	TJSD4242	\$1,317	\$1,448	\$1,488
	48 x 48 x 42	(1) Disc Base	TJSD4842	\$1,380	\$1,529	\$1,575
ROUND TOP SEATED HEIGHT 29"H.						
	24" Dia. x 29	(1) Disc Base	TJRD2429	\$821	\$879	\$897
	30" Dia. x 29	(1) Disc Base	TJRD3029	\$900	\$973	\$996
	36" Dia. x 29	(1) Disc Base	TJRD3629	\$1,006	\$1,094	\$1,121
	42" Dia. x 29	(1) Disc Base	TJRD4229	\$1,251	\$1,354	\$1,385
	48" Dia. x 29	(1) Disc Base	TJRD4829	\$1,308	\$1,426	\$1,462
SQUARE TOP SEATED HEIGHT 29" H.						
	24 x 24 x 29	(1) Disc Base	TJSD2429	\$821	\$896	\$919
	30 x 30 x 29	(1) Disc Base	TJSD3029	\$900	\$993	\$1,022
	36 x 36 x 29	(1) Disc Base	TJSD3629	\$1,006	\$1,118	\$1,153
	42 x 42 x 29	(1) Disc Base	TJSD4229	\$1,251	\$1,382	\$1,422
	48 x 48 x 29	(1) Disc Base	TJSD4829	\$1,308	\$1,458	\$1,504



HPL TOPS | 44 standard HPL finishes

METAL BASES | 11 powder coat finishes

EDGES | matching & coordinating finishes in the following options:

ABS 1: PVC-free impact resistant flat edge (S)

ABS 2: Multi-Ply "Plywood Look" flat vinyl edge (M)

ABS 3: Knife (KV), 1/2" Flat edge- bevel painted in a companion color

- Refer to edge code, above in (), when pricing below -

Standard Features:

- Power/Data options available, consult factory.
- For additional base options, consult factory.

NOTE: Disc bases DO NOT come standard with adjustable leveling glides.

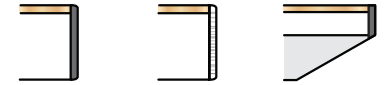

SIZE	BASE INFO #, Style	MODEL #	ABS 1 S	ABS 2 M	ABS 3 KV	
ROUND TOP CAFE HEIGHT 42" H.						
	24" Dia. x 42	(1) Square Base	TJRSD2442	\$1,105	\$1,164	\$1,182
	30" Dia. x 42	(1) Square Base	TJRSD3042	\$1,185	\$1,258	\$1,281
	36" Dia. x 42	(1) Square Base	TJRSD3642	\$1,293	\$1,381	\$1,408
	42" Dia. x 42	(1) Square Base	TJRSD4242	\$1,511	\$1,614	\$1,646
	48" Dia. x 42	(1) Square Base	TJRSD4842	\$1,573	\$1,690	\$1,726
SQUARE TOP CAFE HEIGHT 42" H.						
	24 x 24 x 42	(1) Square Base	TJSSD2442	\$1,105	\$1,180	\$1,203
	30 x 30 x 42	(1) Square Base	TJSSD3042	\$1,185	\$1,278	\$1,307
	36 x 36 x 42	(1) Square Base	TJSSD3642	\$1,293	\$1,405	\$1,440
	42 x 42 x 42	(1) Square Base	TJSSD4242	\$1,511	\$1,642	\$1,682
	48 x 48 x 42	(1) Square Base	TJSSD4842	\$1,785	\$1,934	\$1,980
ROUND TOP SEATED HEIGHT 29"H.						
	24" Dia. x 29	(1) Square Base	TJRSD2429	\$1,019	\$1,077	\$1,095
	30" Dia. x 29	(1) Square Base	TJRSD3029	\$1,098	\$1,171	\$1,194
	36" Dia. x 29	(1) Square Base	TJRSD3629	\$1,202	\$1,290	\$1,318
	42" Dia. x 29	(1) Square Base	TJRSD4229	\$1,511	\$1,614	\$1,646
	48" Dia. x 29	(1) Square Base	TJRSD4829	\$1,570	\$1,687	\$1,724
SQUARE TOP SEATED HEIGHT 29" H.						
	24 x 24 x 29	(1) Square Base	TJSSD2429	\$1,019	\$1,093	\$1,116
	30 x 30 x 29	(1) Square Base	TJSSD3029	\$1,098	\$1,191	\$1,220
	36 x 36 x 29	(1) Square Base	TJSSD3629	\$1,202	\$1,315	\$1,349
	42 x 42 x 29	(1) Square Base	TJSSD4229	\$1,431	\$1,562	\$1,602
	48 x 48 x 29	(1) Square Base	TJSSD4829	\$1,651	\$1,800	\$1,846



HPL TOPS | 44 standard HPL finishes

METAL BASES | 11 powder coat finishes

EDGES | matching & coordinating finishes in the following options:

ABS 1: PVC-free impact resistant flat edge (S)

ABS 2: Multi-Ply "Plywood Look" flat vinyl edge (M)

ABS 3: Knife (KV), 1/2" Flat edge- bevel painted in a companion color



- Refer to edge code, above in (), when pricing below -

Standard Features:

- Power/Data options available, consult factory.
- For additional base options, consult factory.

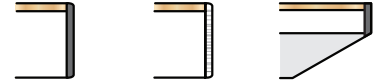
NOTE: Disc bases DO NOT come standard with adjustable leveling glides.

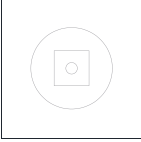

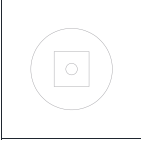
SIZE	BASE INFO #, Style	MODEL #	ABS 1 S	ABS 2 M	ABS 3 KV
ROUND TOP CAFE HEIGHT 42" H.					
 24" Dia. x 42	(1) Disc Base	TJRTD2442	\$1,511	\$1,570	\$1,588
30" Dia. x 42	(1) Disc Base	TJRTD3042	\$1,591	\$1,664	\$1,686
36" Dia. x 42	(1) Disc Base	TJRTD3642	\$1,773	\$1,861	\$1,888
42" Dia. x 42	(1) Disc Base	TJRTD4242	\$1,873	\$1,975	\$2,007
48" Dia. x 42	(1) Disc Base	TJRTD4842	\$1,935	\$2,053	\$2,089
SQUARE TOP CAFE HEIGHT 42" H.					
 24 x 24 x 42	(1) Disc Base	TJSTD2442	\$1,511	\$1,586	\$1,609
30 x 30 x 42	(1) Disc Base	TJSTD3042	\$1,591	\$1,684	\$1,713
36 x 36 x 42	(1) Disc Base	TJSTD3642	\$1,773	\$1,885	\$1,920
42 x 42 x 42	(1) Disc Base	TJSTD4242	\$1,873	\$2,003	\$2,044
48 x 48 x 42	(1) Disc Base	TJSTD4842	\$1,935	\$2,085	\$2,131
ROUND TOP SEATED HEIGHT 29"H.					
 24" Dia. x 29	(1) Disc Base	TJRTD2429	\$1,179	\$1,238	\$1,256
30" Dia. x 29	(1) Disc Base	TJRTD3029	\$1,259	\$1,332	\$1,355
36" Dia. x 29	(1) Disc Base	TJRTD3629	\$1,458	\$1,546	\$1,573
42" Dia. x 29	(1) Disc Base	TJRTD4229	\$1,569	\$1,672	\$1,703
48" Dia. x 29	(1) Disc Base	TJRTD4829	\$1,626	\$1,744	\$1,780
SQUARE TOP SEATED HEIGHT 29" H.					
 24 x 24 x 29	(1) Disc Base	TJSTD2429	\$1,179	\$1,254	\$1,277
30 x 30 x 29	(1) Disc Base	TJSTD3029	\$1,259	\$1,352	\$1,381
36 x 36 x 29	(1) Disc Base	TJSTD3629	\$1,458	\$1,570	\$1,604
42 x 42 x 29	(1) Disc Base	TJSTD4229	\$1,569	\$1,700	\$1,740
48 x 48 x 29	(1) Disc Base	TJSTD4829	\$1,626	\$1,776	\$1,822



HPL TOPS | 44 standard HPL finishes

METAL BASES | 11 powder coat finishes

EDGES | matching & coordinating finishes in the following options:

ABS 1: PVC-free impact resistant flat edge (S)

ABS 2: Multi-Ply "Plywood Look" flat vinyl edge (M)

ABS 3: Knife (KV), 1/2" Flat edge- bevel painted in a companion color

- Refer to edge code, above in (), when pricing below -

Standard Features:

- Power/Data options available, see Power/Data Solutions page.
- Wire management, grommets, etc. available, consult factory.
- For additional base options, consult factory.

NOTE: Disc bases DO NOT come standard with adjustable leveling glides.

(*) Refers to a 2-Piece Top. Spline and Joint Fasteners included with table.

NOTE: Woodgrain pattern alignment between two tops not guaranteed.

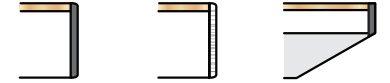

SIZE	BASE INFO #, Style	MODEL #	ABS 1 S	ABS 2 M	ABS 3 KV	
RECTANGLE SHAPE TOP (SQ)						
	42 x 84 x 29	(2) Disc Bases	CJ4284SQ	\$2,419	\$2,628	\$2,692
	42 x 96 x 29	(2) Disc Bases	CJ4296SQ	\$2,553	\$2,777	\$2,846
	48 x 96 x 29	(2) Disc Bases	CJ4896SQ	\$2,590	\$2,814	\$2,883
	* 48 x 120 x 29	(3) Disc Bases	CJ48120SQ	\$3,485	\$3,746	\$3,968
	* 60 x 120 x 29	(3) Disc Bases	CJ60120SQ	\$5,724	\$6,004	\$6,241
	* 48 x 144 x 29	(3) Disc Bases	CJ48144SQ	\$3,930	\$4,229	\$4,482
	* 60 x 144 x 29	(3) Disc Bases	CJ60144SQ	\$6,001	\$6,319	\$6,587
	* 48 x 168 x 29	(4) Disc Bases	CJ48168SQ	\$4,996	\$5,330	\$5,613
	* 60 x 168 x 29	(4) Disc Bases	CJ60168SQ	\$7,593	\$7,948	\$8,248
WEDGE SHAPE TOP (WD)						
	42 x 84 x 29	(2) Disc Bases	CJ4284WD	\$2,550	\$2,759	\$2,823
	42 x 96 x 29	(2) Disc Bases	CJ4296WD	\$2,704	\$2,928	\$2,997
	48 x 96 x 29	(2) Disc Bases	CJ4896WD	\$2,761	\$2,985	\$3,054
	* 48 x 120 x 29	(3) Disc Bases	CJ48120WD	\$3,941	\$4,202	\$4,424
	* 60 x 120 x 29	(3) Disc Bases	CJ60120WD	\$5,992	\$6,272	\$6,509
	* 48 x 144 x 29	(3) Disc Bases	CJ48144WD	\$4,188	\$4,487	\$4,740
	* 60 x 144 x 29	(3) Disc Bases	CJ60144WD	\$6,323	\$6,640	\$6,909
	* 48 x 168 x 29	(4) Disc Bases	CJ48168WD	\$5,297	\$5,632	\$5,914
	* 60 x 168 x 29	(4) Disc Bases	CJ60168WD	\$7,968	\$8,323	\$8,623
BOAT SHAPE TOP (BT)						
	42 x 84 x 29	(2) Disc Bases	CJ4284BT	\$2,584	\$2,792	\$2,857
	42 x 96 x 29	(2) Disc Bases	CJ4296BT	\$2,741	\$2,965	\$3,034
	48 x 96 x 29	(2) Disc Bases	CJ4896BT	\$2,804	\$3,029	\$3,098
	* 48 x 120 x 29	(3) Disc Bases	CJ48120BT	\$3,994	\$4,256	\$4,477
	* 60 x 120 x 29	(3) Disc Bases	CJ60120BT	\$6,058	\$6,339	\$6,576
	* 48 x 144 x 29	(3) Disc Bases	CJ48144BT	\$4,252	\$4,551	\$4,804
	* 60 x 144 x 29	(3) Disc Bases	CJ60144BT	\$6,403	\$6,721	\$6,989
	* 48 x 168 x 29	(4) Disc Bases	CJ48168BT	\$5,372	\$5,706	\$5,988
	* 60 x 168 x 29	(4) Disc Bases	CJ60168BT	\$8,062	\$8,417	\$8,718



HPL TOPS | 44 standard HPL finishes

METAL BASES | 11 powder coat finishes

EDGES | matching & coordinating finishes in the following options:

ABS 1: PVC-free impact resistant flat edge (S)

ABS 2: Multi-Ply "Plywood Look" flat vinyl edge (M)

ABS 3: Knife (KV), 1/2" Flat edge- bevel painted in a companion color

- Refer to edge code, above in (), when pricing below -

Standard Features:

- Power/Data options available, see Power/Data Solutions page.
- Wire management, grommets, etc. available, consult factory.
- For additional base options, consult factory.

NOTE: Disc bases DO NOT come standard with adjustable leveling glides.

(*) Refers to a 2-Piece Top. Spline and Joint Fasteners included with table.

NOTE: Woodgrain pattern alignment between two tops not guaranteed.

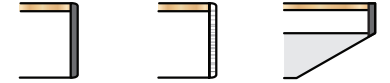

SIZE	BASE INFO #, Style	MODEL #	ABS 1 S	ABS 2 M	ABS 3 KV	
DIAMOND SHAPE TOP (DM)						
	42 x 84 x 29	(2) Disc Bases	CJ4284DM	\$2,584	\$2,792	\$2,857
	42 x 96 x 29	(2) Disc Bases	CJ4296DM	\$2,741	\$2,965	\$3,034
	48 x 96 x 29	(2) Disc Bases	CJ4896DM	\$2,804	\$3,029	\$3,098
	* 48 x 120 x 29	(3) Disc Bases	CJ48120DM	\$3,994	\$4,256	\$4,477
	* 60 x 120 x 29	(3) Disc Bases	CJ60120DM	\$6,058	\$6,339	\$6,576
	* 48 x 144 x 29	(3) Disc Bases	CJ48144DM	\$4,252	\$4,551	\$4,804
	* 60 x 144 x 29	(3) Disc Bases	CJ60144DM	\$6,403	\$6,721	\$6,989
	* 48 x 168 x 29	(4) Disc Bases	CJ48168DM	\$5,372	\$5,706	\$5,988
* 60 x 168 x 29	(4) Disc Bases	CJ60168DM	\$8,062	\$8,417	\$8,718	
BULLET SHAPE TOP (BU)						
	42 x 84 x 29	(2) Disc Bases	CJ4284BU	\$2,584	\$2,766	\$2,822
	42 x 96 x 29	(2) Disc Bases	CJ4296BU	\$2,741	\$2,942	\$3,003
	48 x 96 x 29	(2) Disc Bases	CJ4896BU	\$2,804	\$3,013	\$3,077
	* 48 x 120 x 29	(3) Disc Bases	CJ48120BU	\$3,994	\$4,240	\$4,448
	* 60 x 120 x 29	(3) Disc Bases	CJ60120BU	\$6,058	\$6,323	\$6,547
	* 48 x 144 x 29	(3) Disc Bases	CJ48144BU	\$4,252	\$4,535	\$4,775
	* 60 x 144 x 29	(3) Disc Bases	CJ60144BU	\$6,403	\$6,705	\$6,961
	* 48 x 168 x 29	(4) Disc Bases	CJ48168BU	\$5,372	\$5,692	\$5,964
* 60 x 168 x 29	(4) Disc Bases	CJ60168BU	\$8,062	\$8,402	\$8,689	
BOW END SHAPE TOP (BE)						
	42 x 84 x 29	(2) Disc Bases	CJ4284BE	\$2,584	\$2,792	\$2,857
	42 x 96 x 29	(2) Disc Bases	CJ4296BE	\$2,741	\$2,965	\$3,034
	48 x 96 x 29	(2) Disc Bases	CJ4896BE	\$2,804	\$3,029	\$3,098
	* 48 x 120 x 29	(3) Disc Bases	CJ48120BE	\$3,994	\$4,256	\$4,477
	* 60 x 120 x 29	(3) Disc Bases	CJ60120BE	\$6,058	\$6,339	\$6,576
	* 48 x 144 x 29	(3) Disc Bases	CJ48144BE	\$4,252	\$4,551	\$4,804
	* 60 x 144 x 29	(3) Disc Bases	CJ60144BE	\$6,403	\$6,721	\$6,989
	* 48 x 168 x 29	(4) Disc Bases	CJ48168BE	\$5,372	\$5,706	\$5,988
* 60 x 168 x 29	(4) Disc Bases	CJ60168BE	\$8,062	\$8,417	\$8,718	



HPL TOPS | 44 standard HPL finishes

METAL BASES | 11 powder coat finishes

EDGES | matching & coordinating finishes in the following options:

ABS 1: PVC-free impact resistant flat edge (S)

ABS 2: Multi-Ply "Plywood Look" flat vinyl edge (M)

ABS 3: Knife (KV), 1/2" Flat edge- bevel painted in a companion color

- Refer to edge code, above in (), when pricing below -

Standard Features:

- Power/Data options available, see Power/Data Solutions page.
- Wire management, grommets, etc. available, consult factory.
- For additional base options, consult factory.

NOTE: Disc bases DO NOT come standard with adjustable leveling glides.

(*) Refers to a 2-Piece Top. Spline and Joint Fasteners included with table.

NOTE: Woodgrain pattern alignment between two tops not guaranteed.

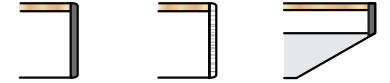

SIZE	BASE INFO #, Style	MODEL #	ABS 1 S	ABS 2 M	ABS 3 KV	
RACETRACK SHAPE TOP (RT)						
	42 x 84 x 29	(2) Disc Bases	CJ4284RT	\$2,600	\$2,768	\$2,820
	42 x 96 x 29	(2) Disc Bases	CJ4296RT	\$2,757	\$2,944	\$3,002
	48 x 96 x 29	(2) Disc Bases	CJ4896RT	\$2,829	\$3,022	\$3,081
	* 48 x 120 x 29	(3) Disc Bases	CJ48120RT	\$3,780	\$4,010	\$4,205
	* 60 x 120 x 29	(3) Disc Bases	CJ60120RT	\$6,091	\$6,341	\$6,551
	* 48 x 144 x 29	(3) Disc Bases	CJ48144RT	\$4,285	\$4,553	\$4,780
	* 60 x 144 x 29	(3) Disc Bases	CJ60144RT	\$6,444	\$6,730	\$6,973
	* 48 x 168 x 29	(4) Disc Bases	CJ48168RT	\$5,409	\$5,713	\$5,971
* 60 x 168 x 29	(4) Disc Bases	CJ60168RT	\$8,110	\$8,433	\$8,706	
BOAT ROUNDED SHAPE TOP (BR)						
	42 x 84 x 29	(2) Disc Bases	CJ4284BR	\$2,600	\$2,809	\$2,873
	42 x 96 x 29	(2) Disc Bases	CJ4296BR	\$2,757	\$2,981	\$3,050
	48 x 96 x 29	(2) Disc Bases	CJ4896BR	\$2,829	\$3,053	\$3,122
	* 48 x 120 x 29	(3) Disc Bases	CJ48120BR	\$3,780	\$4,041	\$4,263
	* 60 x 120 x 29	(3) Disc Bases	CJ60120BR	\$6,091	\$6,372	\$6,609
	* 48 x 144 x 29	(3) Disc Bases	CJ48144BR	\$4,285	\$4,584	\$4,837
	* 60 x 144 x 29	(3) Disc Bases	CJ60144BR	\$6,444	\$6,761	\$7,030
	* 48 x 168 x 29	(4) Disc Bases	CJ48168BR	\$5,409	\$5,743	\$6,025
* 60 x 168 x 29	(4) Disc Bases	CJ60168BR	\$8,110	\$8,465	\$8,765	
OVAL SHAPE TOP (OV)						
	42 x 84 x 29	(2) Disc Bases	CJ4284OV	\$2,600	\$2,758	\$2,806
	42 x 96 x 29	(2) Disc Bases	CJ4296OV	\$2,757	\$2,933	\$2,987
	48 x 96 x 29	(2) Disc Bases	CJ4896OV	\$2,829	\$3,010	\$3,066
	* 48 x 120 x 29	(3) Disc Bases	CJ48120OV	\$3,780	\$3,995	\$4,178
	* 60 x 120 x 29	(3) Disc Bases	CJ60120OV	\$6,091	\$6,316	\$6,507
	* 48 x 144 x 29	(3) Disc Bases	CJ48144OV	\$4,285	\$4,535	\$4,747
	* 60 x 144 x 29	(3) Disc Bases	CJ60144OV	\$6,444	\$6,712	\$6,940
	* 48 x 168 x 29	(4) Disc Bases	CJ48168OV	\$5,409	\$5,733	\$6,008
* 60 x 168 x 29	(4) Disc Bases	CJ60168OV	\$8,110	\$8,453	\$8,744	



HPL TOPS | 44 standard HPL finishes

METAL BASES | 11 powder coat finishes

EDGES | matching & coordinating finishes in the following options:

ABS 1: PVC-free impact resistant flat edge (S)

ABS 2: Multi-Ply "Plywood Look" flat vinyl edge (M)

ABS 3: Knife (KV), 1/2" Flat edge- bevel painted in a companion color

- Refer to edge code, above in (), when pricing below -

Standard Features:

- Power/Data options available, see Power/Data Solutions page.
- Wire management, grommets, etc. available, consult factory.
- For additional base options, consult factory.

NOTE: Disc bases DO NOT come standard with adjustable leveling glides.

(*) Refers to a 2-Piece Top. Spline and Joint Fasteners included with table.

NOTE: Woodgrain pattern alignment between two tops not guaranteed.

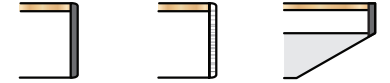

SIZE	BASE INFO #, Style	MODEL #	ABS 1 S	ABS 2 M	ABS 3 KV	
RECTANGLE SHAPE TOP (SQ)						
	42 x 84 x 29	(2) Square Bases	CSJ4284SQ	\$2,376	\$2,584	\$2,648
	42 x 96 x 29	(2) Square Bases	CSJ4296SQ	\$2,510	\$2,734	\$2,803
	48 x 96 x 29	(2) Square Bases	CSJ4896SQ	\$2,596	\$2,821	\$2,890
	* 48 x 120 x 29	(3) Square Bases	CSJ48120SQ	\$3,732	\$3,994	\$4,215
	* 60 x 120 x 29	(3) Square Bases	CSJ60120SQ	\$4,980	\$5,260	\$5,497
	* 48 x 144 x 29	(3) Square Bases	CSJ48144SQ	\$3,937	\$4,236	\$4,489
	* 60 x 144 x 29	(3) Square Bases	CSJ60144SQ	\$5,258	\$5,576	\$5,844
	* 48 x 168 x 29	(4) Square Bases	CSJ48168SQ	\$5,351	\$5,685	\$5,968
	* 60 x 168 x 29	(4) Square Bases	CSJ60168SQ	\$6,598	\$6,953	\$7,254
	WEDGE SHAPE TOP (WD)					
	42 x 84 x 29	(2) Square Bases	CSJ4284WD	\$2,507	\$2,716	\$2,780
	42 x 96 x 29	(2) Square Bases	CSJ4296WD	\$2,660	\$2,884	\$2,953
	48 x 96 x 29	(2) Square Bases	CSJ4896WD	\$2,767	\$2,992	\$3,061
	* 48 x 120 x 29	(3) Square Bases	CSJ48120WD	\$3,947	\$4,209	\$4,430
	* 60 x 120 x 29	(3) Square Bases	CSJ60120WD	\$5,248	\$5,528	\$5,765
	* 48 x 144 x 29	(3) Square Bases	CSJ48144WD	\$4,196	\$4,495	\$4,748
	* 60 x 144 x 29	(3) Square Bases	CSJ60144WD	\$5,580	\$5,897	\$6,166
	* 48 x 168 x 29	(4) Square Bases	CSJ48168WD	\$5,652	\$5,986	\$6,269
* 60 x 168 x 29	(4) Square Bases	CSJ60168WD	\$6,974	\$7,329	\$7,629	
BOAT SHAPE TOP (BT)						
	42 x 84 x 29	(2) Square Bases	CSJ4284BT	\$2,540	\$2,749	\$2,813
	42 x 96 x 29	(2) Square Bases	CSJ4296BT	\$2,697	\$2,921	\$2,990
	48 x 96 x 29	(2) Square Bases	CSJ4896BT	\$2,811	\$3,035	\$3,104
	* 48 x 120 x 29	(3) Square Bases	CSJ48120BT	\$4,001	\$4,262	\$4,484
	* 60 x 120 x 29	(3) Square Bases	CSJ60120BT	\$5,314	\$5,594	\$5,832
	* 48 x 144 x 29	(3) Square Bases	CSJ48144BT	\$4,258	\$4,557	\$4,810
	* 60 x 144 x 29	(3) Square Bases	CSJ60144BT	\$5,660	\$5,978	\$6,247
	* 48 x 168 x 29	(4) Square Bases	CSJ48168BT	\$5,726	\$6,060	\$6,343
* 60 x 168 x 29	(4) Square Bases	CSJ60168BT	\$7,067	\$7,422	\$7,722	



HPL TOPS | 44 standard HPL finishes

METAL BASES | 11 powder coat finishes

EDGES | matching & coordinating finishes in the following options:

ABS 1: PVC-free impact resistant flat edge (S)

ABS 2: Multi-Ply "Plywood Look" flat vinyl edge (M)

ABS 3: Knife (KV), 1/2" Flat edge- bevel painted in a companion color

- Refer to edge code, above in (), when pricing below -

Standard Features:

- Power/Data options available, see Power/Data Solutions page.
- Wire management, grommets, etc. available, consult factory.
- For additional base options, consult factory.

NOTE: Disc bases DO NOT come standard with adjustable leveling glides.

(*) Refers to a 2-Piece Top. Spline and Joint Fasteners included with table.

NOTE: Woodgrain pattern alignment between two tops not guaranteed.

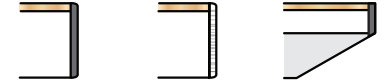

SIZE	BASE INFO #, Style	MODEL #	ABS 1 S	ABS 2 M	ABS 3 KV	
DIAMOND SHAPE TOP (DM)						
	42 x 84 x 29	(2) Square Bases	CSJ4284DM	\$2,540	\$2,749	\$2,813
	42 x 96 x 29	(2) Square Bases	CSJ4296DM	\$2,697	\$2,921	\$2,990
	48 x 96 x 29	(2) Square Bases	CSJ4896DM	\$2,811	\$3,035	\$3,104
	* 48 x 120 x 29	(3) Square Bases	CSJ48120DM	\$4,001	\$4,262	\$4,484
	* 60 x 120 x 29	(3) Square Bases	CSJ60120DM	\$5,314	\$5,594	\$5,832
	* 48 x 144 x 29	(3) Square Bases	CSJ48144DM	\$4,258	\$4,557	\$4,810
	* 60 x 144 x 29	(3) Square Bases	CSJ60144DM	\$5,660	\$5,978	\$6,247
	* 48 x 168 x 29	(4) Square Bases	CSJ48168DM	\$5,726	\$6,060	\$6,343
	* 60 x 168 x 29	(4) Square Bases	CSJ60168DM	\$7,067	\$7,422	\$7,722
BULLET SHAPE TOP (BU)						
	42 x 84 x 29	(2) Square Bases	CSJ4284BU	\$2,540	\$2,722	\$2,779
	42 x 96 x 29	(2) Square Bases	CSJ4296BU	\$2,697	\$2,898	\$2,960
	48 x 96 x 29	(2) Square Bases	CSJ4896BU	\$2,811	\$3,020	\$3,084
	* 48 x 120 x 29	(3) Square Bases	CSJ48120BU	\$4,001	\$4,247	\$4,455
	* 60 x 120 x 29	(3) Square Bases	CSJ60120BU	\$5,314	\$5,579	\$5,803
	* 48 x 144 x 29	(3) Square Bases	CSJ48144BU	\$4,258	\$4,542	\$4,782
	* 60 x 144 x 29	(3) Square Bases	CSJ60144BU	\$5,660	\$5,962	\$6,218
	* 48 x 168 x 29	(4) Square Bases	CSJ48168BU	\$5,726	\$6,047	\$6,319
	* 60 x 168 x 29	(4) Square Bases	CSJ60168BU	\$7,067	\$7,406	\$7,693
BOW END SHAPE TOP (BE)						
	42 x 84 x 29	(2) Square Bases	CSJ4284BE	\$2,540	\$2,749	\$2,813
	42 x 96 x 29	(2) Square Bases	CSJ4296BE	\$2,697	\$2,921	\$2,990
	48 x 96 x 29	(2) Square Bases	CSJ4896BE	\$2,811	\$3,035	\$3,104
	* 48 x 120 x 29	(3) Square Bases	CSJ48120BE	\$4,001	\$4,262	\$4,484
	* 60 x 120 x 29	(3) Square Bases	CSJ60120BE	\$5,314	\$5,594	\$5,832
	* 48 x 144 x 29	(3) Square Bases	CSJ48144BE	\$4,258	\$4,557	\$4,810
	* 60 x 144 x 29	(3) Square Bases	CSJ60144BE	\$5,660	\$5,978	\$6,247
	* 48 x 168 x 29	(4) Square Bases	CSJ48168BE	\$5,726	\$6,060	\$6,343
	* 60 x 168 x 29	(4) Square Bases	CSJ60168BE	\$7,067	\$7,422	\$7,722



HPL TOPS | 44 standard HPL finishes

METAL BASES | 11 powder coat finishes

EDGES | matching & coordinating finishes in the following options:

ABS 1: PVC-free impact resistant flat edge (S)

ABS 2: Multi-Ply "Plywood Look" flat vinyl edge (M)

ABS 3: Knife (KV), 1/2" Flat edge- bevel painted in a companion color

- Refer to edge code, above in (), when pricing below -

Standard Features:

- Power/Data options available, see Power/Data Solutions page.
- Wire management, grommets, etc. available, consult factory.
- For additional base options, consult factory.

NOTE: Disc bases DO NOT come standard with adjustable leveling glides.

(*) Refers to a 2-Piece Top. Spline and Joint Fasteners included with table.

NOTE: Woodgrain pattern alignment between two tops not guaranteed.

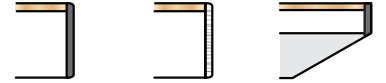

	SIZE	BASE INFO #, Style	MODEL #	ABS 1 S	ABS 2 M	ABS 3 KV
RACETRACK SHAPE TOP (RT)						
	42 x 84 x 29	(2) Square Bases	CSJ4284RT	\$2,557	\$2,725	\$2,777
	42 x 96 x 29	(2) Square Bases	CSJ4296RT	\$2,714	\$2,901	\$2,958
	48 x 96 x 29	(2) Square Bases	CSJ4896RT	\$2,835	\$3,028	\$3,088
	* 48 x 120 x 29	(3) Square Bases	CSJ48120RT	\$4,027	\$4,258	\$4,453
	* 60 x 120 x 29	(3) Square Bases	CSJ60120RT	\$5,349	\$5,598	\$5,809
	* 48 x 144 x 29	(3) Square Bases	CSJ48144RT	\$4,293	\$4,561	\$4,787
	* 60 x 144 x 29	(3) Square Bases	CSJ60144RT	\$5,700	\$5,986	\$6,229
	* 48 x 168 x 29	(4) Square Bases	CSJ48168RT	\$5,763	\$6,068	\$6,325
	* 60 x 168 x 29	(4) Square Bases	CSJ60168RT	\$7,114	\$7,437	\$7,710
BOAT ROUNDED SHAPE TOP (BR)						
	42 x 84 x 29	(2) Square Bases	CSJ4284BR	\$2,557	\$2,766	\$2,830
	42 x 96 x 29	(2) Square Bases	CSJ4296BR	\$2,714	\$2,938	\$3,007
	48 x 96 x 29	(2) Square Bases	CSJ4896BR	\$2,835	\$3,059	\$3,128
	* 48 x 120 x 29	(3) Square Bases	CSJ48120BR	\$4,027	\$4,289	\$4,510
	* 60 x 120 x 29	(3) Square Bases	CSJ60120BR	\$5,349	\$5,629	\$5,866
	* 48 x 144 x 29	(3) Square Bases	CSJ48144BR	\$4,293	\$4,592	\$4,845
	* 60 x 144 x 29	(3) Square Bases	CSJ60144BR	\$5,700	\$6,017	\$6,286
	* 48 x 168 x 29	(4) Square Bases	CSJ48168BR	\$5,763	\$6,097	\$6,380
	* 60 x 168 x 29	(4) Square Bases	CSJ60168BR	\$7,114	\$7,469	\$7,769
OVAL SHAPE TOP (OV)						
	42 x 84 x 29	(2) Square Bases	CSJ4284OV	\$2,557	\$2,714	\$2,763
	42 x 96 x 29	(2) Square Bases	CSJ4296OV	\$2,714	\$2,890	\$2,944
	48 x 96 x 29	(2) Square Bases	CSJ4896OV	\$2,835	\$3,017	\$3,072
	* 48 x 120 x 29	(3) Square Bases	CSJ48120OV	\$4,027	\$4,243	\$4,426
	* 60 x 120 x 29	(3) Square Bases	CSJ60120OV	\$5,349	\$5,574	\$5,764
	* 48 x 144 x 29	(3) Square Bases	CSJ48144OV	\$4,293	\$4,543	\$4,754
	* 60 x 144 x 29	(3) Square Bases	CSJ60144OV	\$5,700	\$5,968	\$6,196
	* 48 x 168 x 29	(4) Square Bases	CSJ48168OV	\$5,763	\$6,088	\$6,363
	* 60 x 168 x 29	(4) Square Bases	CSJ60168OV	\$7,114	\$7,457	\$7,748



HPL TOPS | 44 standard HPL finishes

METAL BASES | 11 powder coat finishes

EDGES | matching & coordinating finishes in the following options:

ABS 1: PVC-free impact resistant flat edge (S)

ABS 2: Multi-Ply "Plywood Look" flat vinyl edge (M)

ABS 3: Knife (KV), 1/2" Flat edge- bevel painted in a companion color

- Refer to edge code, above in (), when pricing below -

Standard Features:

- Power/Data options available, consult factory.
- For additional base options, consult factory.

NOTE: Disc bases DO NOT come standard with adjustable leveling glides.

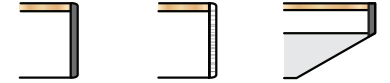

SIZE	BASE INFO #, Style	MODEL #	ABS 1 S	ABS 2 M	ABS 3 KV	
ROUND TOP SIDE TABLE 22" H.						
	24" Dia. x 22	(1) Disc Base	OJRD2422	\$810	\$868	\$886
	30" Dia. x 22	(1) Disc Base	OJRD3022	\$888	\$961	\$984
	36" Dia. x 22	(1) Disc Base	OJRD3622	\$992	\$1,080	\$1,107
	42" Dia. x 22	(1) Disc Base	OJRD4222	\$1,234	\$1,337	\$1,368
	48" Dia. x 22	(1) Disc Base	OJRD4822	\$1,291	\$1,408	\$1,444
SQUARE TOP SIDE TABLE 22" H.						
	24 x 24 x 22	(1) Disc Base	OJSD2422	\$810	\$884	\$907
	30 x 30 x 22	(1) Disc Base	OJSD3022	\$888	\$981	\$1,010
	36 x 36 x 22	(1) Disc Base	OJSD3622	\$992	\$1,104	\$1,139
	42 x 42 x 22	(1) Disc Base	OJSD4222	\$1,234	\$1,365	\$1,405
	48 x 48 x 22	(1) Disc Base	OJSD4822	\$1,291	\$1,440	\$1,486
ROUND TOP COFFEE TABLE 17" H.						
	24" Dia. x 17	(1) Disc Base	OJRD2417	\$797	\$856	\$873
	30" Dia. x 17	(1) Disc Base	OJRD3017	\$875	\$949	\$971
	36" Dia. x 17	(1) Disc Base	OJRD3617	\$980	\$1,068	\$1,095
	42" Dia. x 17	(1) Disc Base	OJRD4217	\$1,221	\$1,324	\$1,356
	48" Dia. x 17	(1) Disc Base	OJRD4817	\$1,278	\$1,395	\$1,432
SQUARE TOP COFFEE TABLE 17" H.						
	24 x 24 x 17	(1) Disc Base	OJSD2417	\$797	\$872	\$895
	30 x 30 x 17	(1) Disc Base	OJSD3017	\$875	\$969	\$997
	36 x 36 x 17	(1) Disc Base	OJSD3617	\$980	\$1,092	\$1,126
	42 x 42 x 17	(1) Disc Base	OJSD4217	\$1,221	\$1,352	\$1,393
	48 x 48 x 17	(1) Disc Base	OJSD4817	\$1,278	\$1,428	\$1,474



HPL TOPS | 44 standard HPL finishes

METAL BASES | 11 powder coat finishes

EDGES | matching & coordinating finishes in the following options:

ABS 1: PVC-free impact resistant flat edge (S)

ABS 2: Multi-Ply "Plywood Look" flat vinyl edge (M)

ABS 3: Knife (KV), 1/2" Flat edge- bevel painted in a companion color

- Refer to edge code, above in (), when pricing below -

Standard Features:

- Power/Data options available, consult factory.
- For additional base options, consult factory.

NOTE: Disc bases DO NOT come standard with adjustable leveling glides.

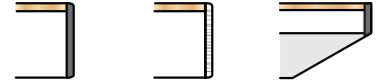

SIZE	BASE INFO #, Style	MODEL #	ABS 1 S	ABS 2 M	ABS 3 KV	
ROUND TOP SIDE TABLE 22" H.						
	24" Dia. x 22	(1) Square Base	OJRSD2422	\$810	\$868	\$886
	30" Dia. x 22	(1) Square Base	OJRSD3022	\$888	\$961	\$984
	36" Dia. x 22	(1) Square Base	OJRSD3622	\$992	\$1,080	\$1,107
	42" Dia. x 22	(1) Square Base	OJRSD4222	\$1,234	\$1,337	\$1,368
	48" Dia. x 22	(1) Square Base	OJRSD4822	\$1,291	\$1,408	\$1,444
SQUARE TOP SIDE TABLE 22" H.						
	24 x 24 x 22	(1) Square Base	OJSSD2422	\$810	\$884	\$907
	30 x 30 x 22	(1) Square Base	OJSSD3022	\$888	\$981	\$1,010
	36 x 36 x 22	(1) Square Base	OJSSD3622	\$992	\$1,104	\$1,139
	42 x 42 x 22	(1) Square Base	OJSSD4222	\$1,234	\$1,365	\$1,405
	48 x 48 x 22	(1) Square Base	OJSSD4822	\$1,291	\$1,440	\$1,486
ROUND TOP COFFEE TABLE 17" H.						
	24" Dia. x 17	(1) Square Base	OJRSD2417	\$797	\$856	\$873
	30" Dia. x 17	(1) Square Base	OJRSD3017	\$875	\$949	\$971
	36" Dia. x 17	(1) Square Base	OJRSD3617	\$980	\$1,068	\$1,095
	42" Dia. x 17	(1) Square Base	OJRSD4217	\$1,221	\$1,324	\$1,356
	48" Dia. x 17	(1) Square Base	OJRSD4817	\$1,278	\$1,395	\$1,432
SQUARE TOP COFFEE TABLE 17" H.						
	24 x 24 x 17	(1) Square Base	OJSSD2417	\$797	\$872	\$895
	30 x 30 x 17	(1) Square Base	OJSSD3017	\$875	\$969	\$997
	36 x 36 x 17	(1) Square Base	OJSSD3617	\$980	\$1,092	\$1,126
	42 x 42 x 17	(1) Square Base	OJSSD4217	\$1,221	\$1,352	\$1,393
	48 x 48 x 17	(1) Square Base	OJSSD4817	\$1,278	\$1,428	\$1,474



ALPINE SERIES



HPL TOPS | 44 standard HPL finishes

METAL BASES | 11 powder coat finishes

EDGES | matching & coordinating finishes in the following options:

ABS 1: PVC-free impact resistant flat edge (S)

ABS 2: Multi-Ply "Plywood Look" flat vinyl edge (M)

ABS 3: Knife (KV), 1/2" Flat edge- bevel painted in a companion color

- Refer to edge code, above in (), when pricing below -

Standard Features:

- Adjustable leveling glides included.
- Power/Data options available, see Power/Data Solutions page.
- For additional base options (casters, flip top, folding, etc.), consult factory.

NOTE: See next page for "Mobile Flip Top" Tables.

- Modesty panel, wire management, grommets, etc. available, consult factory.

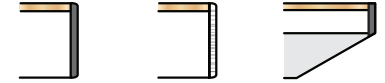

SIZE	BASE INFO #, Style	MODEL #	ABS 1 S	ABS 2 M	ABS 3 KV	
RECTANGULAR TABLES						
	24 x 42 x 29	(2) T-Base	TAL2442	\$842	\$945	\$976
	24 x 48 x 29	(2) T-Base	TAL2448	\$862	\$974	\$1,009
	24 x 60 x 29	(2) T-Base	TAL2460	\$982	\$1,113	\$1,153
	24 x 72 x 29	(2) T-Base	TAL2472	\$1,031	\$1,180	\$1,226
	24 x 84 x 29	(2) T-Base	TAL2484	\$1,119	\$1,287	\$1,339
	24 x 96 x 29	(2) T-Base	TAL2496	\$1,167	\$1,354	\$1,411
	30 x 42 x 29	(2) T-Base	TAL3042	\$936	\$1,048	\$1,082
	30 x 48 x 29	(2) T-Base	TAL3048	\$957	\$1,079	\$1,116
	30 x 60 x 29	(2) T-Base	TAL3060	\$1,079	\$1,220	\$1,263
	30 x 72 x 29	(2) T-Base	TAL3072	\$1,141	\$1,300	\$1,349
	30 x 84 x 29	(2) T-Base	TAL3084	\$1,236	\$1,413	\$1,468
	30 x 96 x 29	(2) T-Base	TAL3096	\$1,270	\$1,466	\$1,526
	36 x 42 x 29	(2) T-Base	TAL3642	\$1,000	\$1,122	\$1,159
	36 x 48 x 29	(2) T-Base	TAL3648	\$1,029	\$1,160	\$1,200
	36 x 60 x 29	(2) T-Base	TAL3660	\$1,166	\$1,316	\$1,362
	36 x 72 x 29	(2) T-Base	TAL3672	\$1,243	\$1,411	\$1,463
	36 x 84 x 29	(2) T-Base	TAL3684	\$1,321	\$1,508	\$1,566
	36 x 96 x 29	(2) T-Base	TAL3696	\$1,374	\$1,580	\$1,643

VIDEO CONFERENCE SHAPE TABLES

THE VIDEO CONFERENCE SHAPE (-VC) CAN BE USED TO CREATE MANY CONFIGURATIONS (BELOW LEFT)
OVERALL SIZE OF TABLE (D x W) LISTED IS NOMINAL AND MAY VARY +/- 1/2"

A	D	W	H						
	20	22	42	29	(2) T-Base	TAL2242-VC	\$996	\$1,091	\$1,120
	24	27	50	29	(2) T-Base	TAL2750-VC	\$1,086	\$1,199	\$1,234
	30	34	61	29	(2) T-Base	TAL3461-VC	\$1,310	\$1,451	\$1,494
	36	41	73	29	(2) T-Base	TAL4173-VC	\$1,492	\$1,661	\$1,713

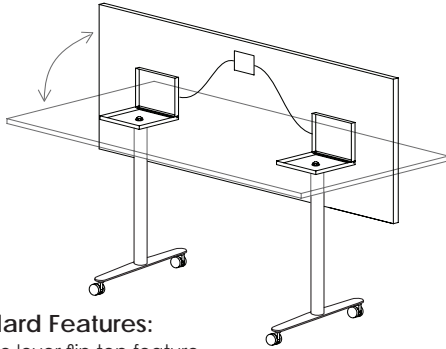

Standard Features:

- Single lever flip top feature.
- 2" Locking casters included. (Specify for hard floor or carpeted areas)
- Power/Data options available, see Power/Data Solutions page.
- Modesty panel, wire management, grommets, etc. available, consult factory.

HPL TOPS | 44 standard HPL finishes

METAL BASES | 11 powder coat finishes

EDGES | matching & coordinating finishes in the following options:

ABS 1: PVC-free impact resistant flat edge (S)

ABS 2: Multi-Ply "Plywood Look" flat vinyl edge (M)

ABS 3: Knife (KV), 1/2" Flat edge- bevel painted in a companion color

- Refer to edge code, above in (), when pricing below -

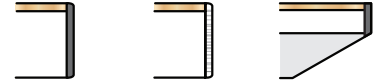

SIZE	BASE INFO #, Style	MODEL #	ABS 1 S	ABS 2 M	ABS 3 KV	
RECTANGULAR TABLES						
	24 x 42 x 29	(2) T-Base	TAL2442-FL	\$1,268	\$1,370	\$1,402
	24 x 48 x 29	(2) T-Base	TAL2448-FL	\$1,288	\$1,400	\$1,434
	24 x 60 x 29	(2) T-Base	TAL2460-FL	\$1,407	\$1,538	\$1,578
	24 x 72 x 29	(2) T-Base	TAL2472-FL	\$1,456	\$1,606	\$1,652
	24 x 84 x 29	(2) T-Base	TAL2484-FL	\$1,545	\$1,713	\$1,764
	24 x 96 x 29	(2) T-Base	TAL2496-FL	\$1,592	\$1,779	\$1,837
	30 x 42 x 29	(2) T-Base	TAL3042-FL	\$1,361	\$1,473	\$1,508
	30 x 48 x 29	(2) T-Base	TAL3048-FL	\$1,383	\$1,504	\$1,542
	30 x 60 x 29	(2) T-Base	TAL3060-FL	\$1,505	\$1,645	\$1,688
	30 x 72 x 29	(2) T-Base	TAL3072-FL	\$1,567	\$1,725	\$1,774
	30 x 84 x 29	(2) T-Base	TAL3084-FL	\$1,661	\$1,839	\$1,893
	30 x 96 x 29	(2) T-Base	TAL3096-FL	\$1,695	\$1,891	\$1,952
	36 x 42 x 29	(2) T-Base	TAL3642-FL	\$1,426	\$1,547	\$1,584
	36 x 48 x 29	(2) T-Base	TAL3648-FL	\$1,455	\$1,585	\$1,626
	36 x 60 x 29	(2) T-Base	TAL3660-FL	\$1,592	\$1,741	\$1,787
	36 x 72 x 29	(2) T-Base	TAL3672-FL	\$1,669	\$1,837	\$1,889
	36 x 84 x 29	(2) T-Base	TAL3684-FL	\$1,747	\$1,934	\$1,991
	36 x 96 x 29	(2) T-Base	TAL3696-FL	\$1,800	\$2,005	\$2,068

VIDEO CONFERENCE SHAPE TABLES

THE VIDEO CONFERENCE SHAPE (-VC) CAN BE USED TO CREATE MANY CONFIGURATIONS (BELOW LEFT)
OVERALL SIZE OF TABLE (D x W) LISTED IS NOMINAL AND MAY VARY +/- 1/2"

A D W H

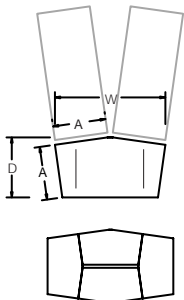

20 x 22 x 42 x 29	(2) T-Base	TAL2242-VC-FL	\$1,421	\$1,516	\$1,545
24 x 27 x 50 x 29	(2) T-Base	TAL2750-VC-FL	\$1,511	\$1,625	\$1,660
30 x 34 x 61 x 29	(2) T-Base	TAL3461-VC-FL	\$1,735	\$1,876	\$1,920
36 x 41 x 73 x 29	(2) T-Base	TAL4173-VC-FL	\$1,918	\$2,087	\$2,139



WOODWARD SERIES



HPL TOPS | 44 standard HPL finishes

METAL BASES | 11 powder coat finishes

EDGES | matching & coordinating finishes in the following options:

ABS 1: PVC-free impact resistant flat edge (S)

ABS 2: Multi-Ply "Plywood Look" flat vinyl edge (M)



ABS 3: Knife (KV), 1/2" Flat edge- bevel painted in a companion color

- Refer to edge code, above in (), when pricing below -

Standard Features:

- Adjustable leveling glides included.
- Power/Data options available, consult factory.
- For additional base options (casters, flip top, etc.), consult factory.

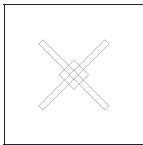

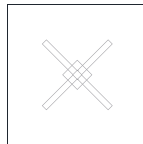
SIZE	BASE INFO #, Style	MODEL #	ABS 1 S	ABS 2 M	ABS 3 KV	
ROUND TOP CAFE HEIGHT 42" H.						
	30" Dia. x 42	(1) X-Base	TWRX3042	\$861	\$935	\$957
	36" Dia. x 42	(1) X-Base	TWRX3642	\$1,021	\$1,109	\$1,136
	42" Dia. x 42	(1) X-Base	TWRX4242	\$1,117	\$1,220	\$1,251
	48" Dia. x 42	(1) X-Base	TWRX4842	\$1,208	\$1,325	\$1,361
	54" Dia. x 42	(1) X-Base	TWRX5442	\$1,327	\$1,459	\$1,500
SQUARE TOP CAFE HEIGHT 42" H.						
	24 x 24 x 42	(1) X-Base	TWSX2442	\$810	\$884	\$907
	30 x 30 x 42	(1) X-Base	TWSX3042	\$861	\$955	\$984
	36 x 36 x 42	(1) X-Base	TWSX3642	\$1,021	\$1,133	\$1,168
	42 x 42 x 42	(1) X-Base	TWSX4242	\$1,117	\$1,248	\$1,288
	48 x 48 x 42	(1) X-Base	TWSX4842	\$1,208	\$1,357	\$1,403
	54 x 54 x 42	(1) X-Base	TWSX5442	\$1,327	\$1,495	\$1,638
ROUND TOP SEATED HEIGHT 29"H.						
	30" Dia. x 29	(1) X-Base	TWRX3029	\$772	\$845	\$868
	36" Dia. x 29	(1) X-Base	TWRX3629	\$929	\$1,017	\$1,044
	42" Dia. x 29	(1) X-Base	TWRX4229	\$1,035	\$1,138	\$1,169
	48" Dia. x 29	(1) X-Base	TWRX4829	\$1,128	\$1,246	\$1,282
	54" Dia. x 29	(1) X-Base	TWRX5429	\$1,254	\$1,386	\$1,427
SQUARE TOP SEATED HEIGHT 29" H.						
	24 x 24 x 29	(1) X-Base	TWSX2429	\$714	\$789	\$812
	30 x 30 x 29	(1) X-Base	TWSX3029	\$772	\$865	\$894
	36 x 36 x 29	(1) X-Base	TWSX3629	\$929	\$1,041	\$1,076
	42 x 42 x 29	(1) X-Base	TWSX4229	\$1,035	\$1,166	\$1,206
	48 x 48 x 29	(1) X-Base	TWSX4829	\$1,128	\$1,278	\$1,324
	54 x 54 x 29	(1) X-Base	TWSX5429	\$1,254	\$1,422	\$1,565



HPL TOPS | 44 standard HPL finishes

METAL BASES | 11 powder coat finishes

EDGES | matching & coordinating finishes in the following options:

ABS 1: PVC-free impact resistant flat edge (S)

ABS 2: Multi-Ply "Plywood Look" flat vinyl edge (M)

ABS 3: Knife (KV), 1/2" Flat edge- bevel painted in a companion color

- Refer to edge code, above in (), when pricing below -

Standard Features:

- Adjustable leveling glides included.
- Power/Data options available, see Power/Data Solutions page.
- For additional base options (casters, flip top, folding, etc.), consult factory.

NOTE: See next page for "Mobile Flip Top" Tables.

- Modesty panel, wire management, grommets, etc. available, consult factory.

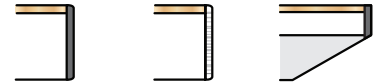

SIZE	BASE INFO #, Style	MODEL #	ABS 1 S	ABS 2 M	ABS 3 KV	
RECTANGULAR TABLES						
	18 x 42 x 29	(2) T-Bases	TW1842	\$691	\$785	\$814
	18 x 48 x 29	(2) T-Bases	TW1848	\$723	\$826	\$857
	18 x 60 x 29	(2) T-Bases	TW1860	\$842	\$964	\$1,001
	18 x 72 x 29	(2) T-Bases	TW1872	\$888	\$1,028	\$1,071
	18 x 84 x 29	(2) T-Bases	TW1884	\$952	\$1,111	\$1,160
	18 x 96 x 29	(2) T-Bases	TW1896	\$995	\$1,172	\$1,227
	20 x 42 x 29	(2) T-Bases	TW2042	\$729	\$826	\$855
	20 x 48 x 29	(2) T-Bases	TW2048	\$749	\$855	\$888
	20 x 60 x 29	(2) T-Bases	TW2060	\$866	\$991	\$1,029
	20 x 72 x 29	(2) T-Bases	TW2072	\$913	\$1,056	\$1,100
20 x 84 x 29	(2) T-Bases	TW2084	\$983	\$1,145	\$1,195	
20 x 96 x 29	(2) T-Bases	TW2096	\$1,028	\$1,208	\$1,264	
24 x 42 x 29	(2) T-Bases	TW2442	\$766	\$868	\$900	
24 x 48 x 29	(2) T-Bases	TW2448	\$785	\$897	\$931	
24 x 60 x 29	(2) T-Bases	TW2460	\$904	\$1,035	\$1,075	
24 x 72 x 29	(2) T-Bases	TW2472	\$953	\$1,103	\$1,149	
24 x 84 x 29	(2) T-Bases	TW2484	\$1,041	\$1,210	\$1,261	
24 x 96 x 29	(2) T-Bases	TW2496	\$1,089	\$1,276	\$1,334	
30 x 42 x 29	(2) T-Bases	TW3042	\$866	\$978	\$1,013	
30 x 48 x 29	(2) T-Bases	TW3048	\$888	\$1,009	\$1,047	
30 x 60 x 29	(2) T-Bases	TW3060	\$1,010	\$1,150	\$1,193	
30 x 72 x 29	(2) T-Bases	TW3072	\$1,072	\$1,230	\$1,279	
30 x 84 x 29	(2) T-Bases	TW3084	\$1,165	\$1,342	\$1,397	
30 x 96 x 29	(2) T-Bases	TW3096	\$1,200	\$1,396	\$1,457	
36 x 42 x 29	(2) T-Bases	TW3642	\$931	\$1,052	\$1,089	
36 x 48 x 29	(2) T-Bases	TW3648	\$958	\$1,089	\$1,129	
36 x 60 x 29	(2) T-Bases	TW3660	\$1,096	\$1,245	\$1,291	
36 x 72 x 29	(2) T-Bases	TW3672	\$1,174	\$1,342	\$1,394	
36 x 84 x 29	(2) T-Bases	TW3684	\$1,252	\$1,439	\$1,496	
36 x 96 x 29	(2) T-Bases	TW3696	\$1,305	\$1,510	\$1,573	

VIDEO CONFERENCE SHAPE TABLES

THE VIDEO CONFERENCE SHAPE (-VC) CAN BE USED TO CREATE MANY CONFIGURATIONS (BELOW LEFT)
OVERALL SIZE OF TABLE (D x W) LISTED IS NOMINAL AND MAY VARY +/- 1/2"

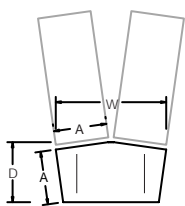

A	D	W	H					
20	22	42	29	(2) T-Bases	TW2242-VC	\$903	\$998	\$1,027
24	27	50	29	(2) T-Bases	TW2750-VC	\$1,035	\$1,149	\$1,184
30	34	61	29	(2) T-Bases	TW3461-VC	\$1,266	\$1,406	\$1,450
36	41	73	29	(2) T-Bases	TW4173-VC	\$1,428	\$1,597	\$1,649

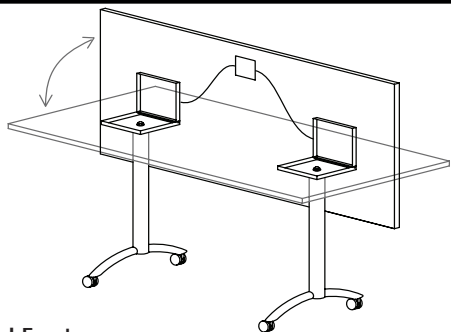

HPL TOPS | 44 standard HPL finishes

METAL BASES | 11 powder coat finishes

EDGES | matching & coordinating finishes in the following options:

ABS 1: PVC-free impact resistant flat edge (S)

ABS 2: Multi-Ply "Plywood Look" flat vinyl edge (M)

ABS 3: Knife (KV), 1/2" Flat edge- bevel painted in a companion color

- Refer to edge code, above in (), when pricing below -



Standard Features:

- Single lever flip top feature.
- 2" Locking casters included. (Specify for hard floor or carpeted areas)
- Power/Data options available, see Power/Data Solutions page.
- Modesty panel, wire management, grommets, etc. available, consult factory.

SIZE	BASE INFO #, Style	MODEL #	ABS 1 S	ABS 2 M	ABS 3 KV	
RECTANGULAR TABLES						
	18 x 42 x 29	(2) T-Bases	TW1842-FL	\$1,117	\$1,210	\$1,239
	18 x 48 x 29	(2) T-Bases	TW1848-FL	\$1,148	\$1,251	\$1,283
	18 x 60 x 29	(2) T-Bases	TW1860-FL	\$1,268	\$1,389	\$1,427
	18 x 72 x 29	(2) T-Bases	TW1872-FL	\$1,313	\$1,453	\$1,497
	18 x 84 x 29	(2) T-Bases	TW1884-FL	\$1,377	\$1,536	\$1,585
	18 x 96 x 29	(2) T-Bases	TW1896-FL	\$1,420	\$1,598	\$1,652
	20 x 42 x 29	(2) T-Bases	TW2042-FL	\$1,155	\$1,251	\$1,281
	20 x 48 x 29	(2) T-Bases	TW2048-FL	\$1,175	\$1,281	\$1,313
	20 x 60 x 29	(2) T-Bases	TW2060-FL	\$1,292	\$1,416	\$1,455
	20 x 72 x 29	(2) T-Bases	TW2072-FL	\$1,338	\$1,482	\$1,526
	20 x 84 x 29	(2) T-Bases	TW2084-FL	\$1,409	\$1,571	\$1,621
	20 x 96 x 29	(2) T-Bases	TW2096-FL	\$1,453	\$1,634	\$1,689
	24 x 42 x 29	(2) T-Bases	TW2442-FL	\$1,191	\$1,294	\$1,326
	24 x 48 x 29	(2) T-Bases	TW2448-FL	\$1,210	\$1,322	\$1,357
	24 x 60 x 29	(2) T-Bases	TW2460-FL	\$1,330	\$1,460	\$1,501
	24 x 72 x 29	(2) T-Bases	TW2472-FL	\$1,379	\$1,528	\$1,574
	24 x 84 x 29	(2) T-Bases	TW2484-FL	\$1,467	\$1,635	\$1,687
	24 x 96 x 29	(2) T-Bases	TW2496-FL	\$1,515	\$1,702	\$1,759
	30 x 42 x 29	(2) T-Bases	TW3042-FL	\$1,292	\$1,404	\$1,438
	30 x 48 x 29	(2) T-Bases	TW3048-FL	\$1,313	\$1,435	\$1,472
30 x 60 x 29	(2) T-Bases	TW3060-FL	\$1,435	\$1,576	\$1,619	
30 x 72 x 29	(2) T-Bases	TW3072-FL	\$1,497	\$1,656	\$1,705	
30 x 84 x 29	(2) T-Bases	TW3084-FL	\$1,590	\$1,768	\$1,822	
30 x 96 x 29	(2) T-Bases	TW3096-FL	\$1,626	\$1,822	\$1,882	
36 x 42 x 29	(2) T-Bases	TW3642-FL	\$1,356	\$1,478	\$1,515	
36 x 48 x 29	(2) T-Bases	TW3648-FL	\$1,384	\$1,515	\$1,555	
36 x 60 x 29	(2) T-Bases	TW3660-FL	\$1,521	\$1,671	\$1,717	
36 x 72 x 29	(2) T-Bases	TW3672-FL	\$1,599	\$1,767	\$1,819	
36 x 84 x 29	(2) T-Bases	TW3684-FL	\$1,677	\$1,864	\$1,922	
36 x 96 x 29	(2) T-Bases	TW3696-FL	\$1,730	\$1,936	\$1,999	

VIDEO CONFERENCE SHAPE TABLES

A D W H

THE VIDEO CONFERRING SHAPE (-VC) CAN BE USED TO CREATE MANY CONFIGURATIONS (BELOW LEFT)
OVERALL SIZE OF TABLE (D x W) LISTED IS NOMINAL AND MAY VARY +/- 1/2"

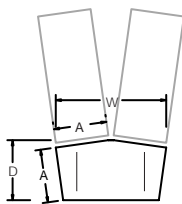

20 x 22 x 42 x 29	(2) T-Bases	TW2242-VC-FL	\$1,328	\$1,423	\$1,453
24 x 27 x 50 x 29	(2) T-Bases	TW2750-VC-FL	\$1,461	\$1,574	\$1,609
30 x 34 x 61 x 29	(2) T-Bases	TW3461-VC-FL	\$1,691	\$1,832	\$1,875
36 x 41 x 73 x 29	(2) T-Bases	TW4173-VC-FL	\$1,853	\$2,022	\$2,074

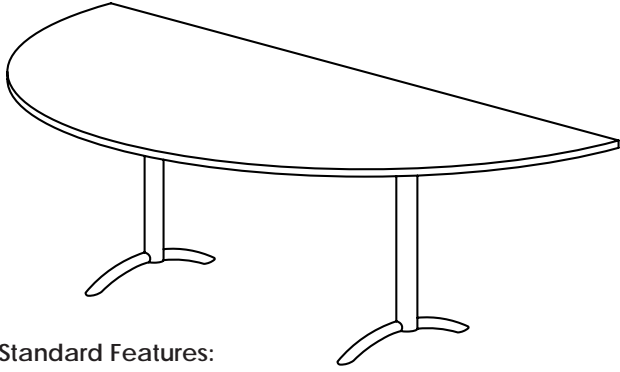

HPL TOPS | 44 standard HPL finishes

METAL BASES | 11 powder coat finishes

EDGES | matching & coordinating finishes in the following options:

ABS 1: PVC-free impact resistant flat edge (S)

ABS 2: Multi-Ply "Plywood Look" flat vinyl edge (M)

ABS 3: Knife (KV), 1/2" Flat edge- bevel painted in a companion color

- Refer to edge code, above in (), when pricing below -

Standard Features:

- Adjustable leveling glides included.
- Power/Data options available, consult factory.
- For additional base options (casters, flip top, etc.), consult factory.

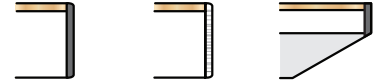

	SIZE	BASE INFO #, Style	MODEL #	ABS 1 S	ABS 2 M	ABS 3 KV
HALF ROUND						
	18 x 36 x 29	(2) T-Bases	TWHR1836	\$737	\$809	\$831
	20 x 40 x 29	(2) T-Bases	TWHR2040	\$793	\$873	\$898
	24 x 48 x 29	(2) T-Bases	TWHR2448	\$858	\$954	\$983
	30 x 60 x 29	(2) T-Bases	TWHR3060	\$1,023	\$1,143	\$1,180
	36 x 72 x 29	(2) T-Bases	TWHR3672	\$1,279	\$1,423	\$1,468
CRESCENT						
	18 x 48 x 29	(2) T-Bases	TWCR1848	\$1,185	\$1,288	\$1,319
	18 x 60 x 29	(2) T-Bases	TWCR1860	\$1,355	\$1,476	\$1,514
	24 x 48 x 29	(2) T-Bases	TWCR2448	\$1,279	\$1,392	\$1,426
	24 x 60 x 29	(2) T-Bases	TWCR2460	\$1,456	\$1,587	\$1,627
	30 x 48 x 29	(2) T-Bases	TWCR3048	\$1,342	\$1,464	\$1,501
	30 x 60 x 29	(2) T-Bases	TWCR3060	\$1,585	\$1,726	\$1,769
TRAPEZOID						
	24 x 48 x 29	(2) T-Bases	TWTR2448	\$860	\$972	\$1,007
	24 x 60 x 29	(2) T-Bases	TWTR2460	\$931	\$1,061	\$1,102
	24 x 72 x 29	(2) T-Bases	TWTR2472	\$1,072	\$1,221	\$1,267
	30 x 48 x 29	(2) T-Bases	TWTR3048	\$947	\$1,068	\$1,106
	30 x 60 x 29	(2) T-Bases	TWTR3060	\$1,020	\$1,160	\$1,203
	30 x 72 x 29	(2) T-Bases	TWTR3072	\$1,148	\$1,307	\$1,356
	36 x 48 x 29	(2) T-Bases	TWTR3648	\$1,020	\$1,151	\$1,191
	36 x 60 x 29	(2) T-Bases	TWTR3660	\$1,111	\$1,260	\$1,306
	36 x 72 x 29	(2) T-Bases	TWTR3672	\$1,258	\$1,426	\$1,478
QUARTER ROUND						
	24 x 24 x 29	(2) T-Bases	TWQR2424	\$740	\$807	\$828
	30 x 30 x 29	(2) T-Bases	TWQR3030	\$836	\$920	\$945
	36 x 36 x 29	(2) T-Bases	TWQR3636	\$934	\$1,034	\$1,065



CAP SERIES



HPL TOPS | 44 standard HPL finishes

METAL BASES | 11 powder coat finishes

EDGES | matching & coordinating finishes in the following options:

ABS 1: PVC-free impact resistant flat edge (**S**)

ABS 2: Multi-Ply "Plywood Look" flat vinyl edge (**M**)

ABS 3: Knife (**KV**), 1/2" Flat edge- bevel painted in a companion color

- Refer to edge code, above in (), when pricing below -

Standard Features:

- Adjustable leveling glides included.
- Power/Data options available, see Power/Data Solutions page.
- Wire management, grommets, etc. available, consult factory.

(*) Refers to a 2-Piece Top. Spline and Joint Fasteners included with table.

NOTE: Woodgrain pattern alignment between two tops not guaranteed.

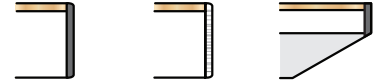

SIZE	BASE INFO #, Style	MODEL #	ABS 1 S	ABS 2 M	ABS 3 KV	
RECTANGLE SHAPE TOP (SQ)						
	42 x 84 x 29	(2) Flat CAP Bases	CFC4284SQ	\$2,928	\$3,137	\$3,201
	42 x 96 x 29	(2) Flat CAP Bases	CFC4296SQ	\$3,062	\$3,287	\$3,356
	48 x 96 x 29	(2) Flat CAP Bases	CFC4896SQ	\$3,099	\$3,324	\$3,393
	* 48 x 120 x 29	(3) Flat CAP Bases	CFC48120SQ	\$4,496	\$4,757	\$4,979
	* 60 x 120 x 29	(3) Flat CAP Bases	CFC60120SQ	\$5,617	\$5,897	\$6,134
	* 48 x 144 x 29	(3) Flat CAP Bases	CFC48144SQ	\$4,701	\$5,000	\$5,253
	* 60 x 144 x 29	(3) Flat CAP Bases	CFC60144SQ	\$5,894	\$6,211	\$6,480
	* 48 x 168 x 29	(4) Flat CAP Bases	CFC48168SQ	\$6,021	\$6,355	\$6,638
	* 60 x 168 x 29	(4) Flat CAP Bases	CFC60168SQ	\$7,448	\$7,803	\$8,104
WEDGE SHAPE TOP (WD)						
	42 x 84 x 29	(2) Flat CAP Bases	CFC4284WD	\$3,060	\$3,268	\$3,333
	42 x 96 x 29	(2) Flat CAP Bases	CFC4296WD	\$3,213	\$3,437	\$3,506
	48 x 96 x 29	(2) Flat CAP Bases	CFC4896WD	\$3,270	\$3,495	\$3,564
	* 48 x 120 x 29	(3) Flat CAP Bases	CFC48120WD	\$4,712	\$4,973	\$5,195
	* 60 x 120 x 29	(3) Flat CAP Bases	CFC60120WD	\$5,885	\$6,165	\$6,402
	* 48 x 144 x 29	(3) Flat CAP Bases	CFC48144WD	\$4,959	\$5,258	\$5,511
	* 60 x 144 x 29	(3) Flat CAP Bases	CFC60144WD	\$6,215	\$6,533	\$6,802
	* 48 x 168 x 29	(4) Flat CAP Bases	CFC48168WD	\$6,323	\$6,657	\$6,939
* 60 x 168 x 29	(4) Flat CAP Bases	CFC60168WD	\$7,824	\$8,179	\$8,479	
BOAT SHAPE TOP (BT)						
	42 x 84 x 29	(2) Flat CAP Bases	CFC4284BT	\$3,093	\$3,302	\$3,366
	42 x 96 x 29	(2) Flat CAP Bases	CFC4296BT	\$3,250	\$3,474	\$3,543
	48 x 96 x 29	(2) Flat CAP Bases	CFC4896BT	\$3,314	\$3,538	\$3,607
	* 48 x 120 x 29	(3) Flat CAP Bases	CFC48120BT	\$4,765	\$5,027	\$5,248
	* 60 x 120 x 29	(3) Flat CAP Bases	CFC60120BT	\$5,951	\$6,231	\$6,469
	* 48 x 144 x 29	(3) Flat CAP Bases	CFC48144BT	\$5,023	\$5,322	\$5,575
	* 60 x 144 x 29	(3) Flat CAP Bases	CFC60144BT	\$6,296	\$6,613	\$6,882
	* 48 x 168 x 29	(4) Flat CAP Bases	CFC48168BT	\$6,397	\$6,731	\$7,013
* 60 x 168 x 29	(4) Flat CAP Bases	CFC60168BT	\$7,918	\$8,273	\$8,574	



HPL TOPS | 44 standard HPL finishes

METAL BASES | 11 powder coat finishes

EDGES | matching & coordinating finishes in the following options:

ABS 1: PVC-free impact resistant flat edge (S)

ABS 2: Multi-Ply "Plywood Look" flat vinyl edge (M)

ABS 3: Knife (KV), 1/2" Flat edge- bevel painted in a companion color

- Refer to edge code, above in (), when pricing below -

Standard Features:

- Adjustable leveling glides included.
- Power/Data options available, see Power/Data Solutions page.
- Wire management, grommets, etc. available, consult factory.

(*) Refers to a 2-Piece Top. Spline and Joint Fasteners included with table.

NOTE: Woodgrain pattern alignment between two tops not guaranteed.



SIZE	BASE INFO #, Style	MODEL #	ABS 1 S	ABS 2 M	ABS 3 KV	
DIAMOND SHAPE TOP (DM)						
	42 x 84 x 29	(2) Flat CAP Bases	CFC4284DM	\$3,093	\$3,302	\$3,366
	42 x 96 x 29	(2) Flat CAP Bases	CFC4296DM	\$3,250	\$3,474	\$3,543
	48 x 96 x 29	(2) Flat CAP Bases	CFC4896DM	\$3,314	\$3,538	\$3,607
	* 48 x 120 x 29	(3) Flat CAP Bases	CFC48120DM	\$4,765	\$5,027	\$5,248
	* 60 x 120 x 29	(3) Flat CAP Bases	CFC60120DM	\$5,951	\$6,231	\$6,469
	* 48 x 144 x 29	(3) Flat CAP Bases	CFC48144DM	\$5,023	\$5,322	\$5,575
	* 60 x 144 x 29	(3) Flat CAP Bases	CFC60144DM	\$6,296	\$6,613	\$6,882
	* 48 x 168 x 29	(4) Flat CAP Bases	CFC48168DM	\$6,397	\$6,731	\$7,013
	* 60 x 168 x 29	(4) Flat CAP Bases	CFC60168DM	\$7,918	\$8,273	\$8,574
BULLET SHAPE TOP (BU)						
	42 x 84 x 29	(2) Flat CAP Bases	CFC4284BU	\$3,093	\$3,275	\$3,331
	42 x 96 x 29	(2) Flat CAP Bases	CFC4296BU	\$3,250	\$3,451	\$3,513
	48 x 96 x 29	(2) Flat CAP Bases	CFC4896BU	\$3,314	\$3,522	\$3,587
	* 48 x 120 x 29	(3) Flat CAP Bases	CFC48120BU	\$4,765	\$5,011	\$5,219
	* 60 x 120 x 29	(3) Flat CAP Bases	CFC60120BU	\$5,951	\$6,216	\$6,440
	* 48 x 144 x 29	(3) Flat CAP Bases	CFC48144BU	\$5,023	\$5,306	\$5,546
	* 60 x 144 x 29	(3) Flat CAP Bases	CFC60144BU	\$6,296	\$6,598	\$6,853
	* 60 x 168 x 29	(4) Flat CAP Bases	CFC48168BU	\$6,397	\$6,717	\$6,989
BOW END SHAPE TOP (BE)						
	42 x 84 x 29	(2) Flat CAP Bases	CFC4284BE	\$3,093	\$3,302	\$3,366
	42 x 96 x 29	(2) Flat CAP Bases	CFC4296BE	\$3,250	\$3,474	\$3,543
	48 x 96 x 29	(2) Flat CAP Bases	CFC4896BE	\$3,314	\$3,538	\$3,607
	* 48 x 120 x 29	(3) Flat CAP Bases	CFC48120BE	\$4,765	\$5,027	\$5,248
	* 60 x 120 x 29	(3) Flat CAP Bases	CFC60120BE	\$5,951	\$6,231	\$6,469
	* 48 x 144 x 29	(3) Flat CAP Bases	CFC48144BE	\$5,023	\$5,322	\$5,575
	* 60 x 144 x 29	(3) Flat CAP Bases	CFC60144BE	\$6,296	\$6,613	\$6,882
	* 48 x 168 x 29	(4) Flat CAP Bases	CFC48168BE	\$6,397	\$6,731	\$7,013
* 60 x 168 x 29	(4) Flat CAP Bases	CFC60168BE	\$7,918	\$8,273	\$8,574	



HPL TOPS | 44 standard HPL finishes

METAL BASES | 11 powder coat finishes

EDGES | matching & coordinating finishes in the following options:

ABS 1: PVC-free impact resistant flat edge (S)

ABS 2: Multi-Ply "Plywood Look" flat vinyl edge (M)

ABS 3: Knife (KV), 1/2" Flat edge- bevel painted in a companion color

- Refer to edge code, above in (), when pricing below -

Standard Features:

- Adjustable leveling glides included.
- Power/Data options available, see Power/Data Solutions page.
- Wire management, grommets, etc. available, consult factory.

(*) Refers to a 2-Piece Top. Spline and Joint Fasteners included with table.

NOTE: Woodgrain pattern alignment between two tops not guaranteed.

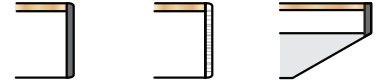

	SIZE	BASE INFO #, Style	MODEL #	ABS 1 S	ABS 2 M	ABS 3 KV
RACETRACK SHAPE TOP (RT)						
	42 x 84 x 29	(2) Flat CAP Bases	CFC4284RT	\$3,110	\$3,278	\$3,329
	42 x 96 x 29	(2) Flat CAP Bases	CFC4296RT	\$3,267	\$3,453	\$3,511
	48 x 96 x 29	(2) Flat CAP Bases	CFC4896RT	\$3,338	\$3,531	\$3,591
	* 48 x 120 x 29	(3) Flat CAP Bases	CFC48120RT	\$4,792	\$5,022	\$5,217
	* 60 x 120 x 29	(3) Flat CAP Bases	CFC60120RT	\$5,984	\$6,233	\$6,444
	* 48 x 144 x 29	(3) Flat CAP Bases	CFC48144RT	\$5,056	\$5,324	\$5,551
	* 60 x 144 x 29	(3) Flat CAP Bases	CFC60144RT	\$6,337	\$6,623	\$6,866
	* 48 x 168 x 29	(4) Flat CAP Bases	CFC48168RT	\$6,434	\$6,738	\$6,996
	* 60 x 168 x 29	(4) Flat CAP Bases	CFC60168RT	\$7,965	\$8,288	\$8,562
BOAT ROUNDED SHAPE TOP (BR)						
	42 x 84 x 29	(2) Flat CAP Bases	CFC4284BR	\$3,110	\$3,318	\$3,382
	42 x 96 x 29	(2) Flat CAP Bases	CFC4296BR	\$3,267	\$3,491	\$3,560
	48 x 96 x 29	(2) Flat CAP Bases	CFC4896BR	\$3,338	\$3,562	\$3,631
	* 48 x 120 x 29	(3) Flat CAP Bases	CFC48120BR	\$4,792	\$5,054	\$5,275
	* 60 x 120 x 29	(3) Flat CAP Bases	CFC60120BR	\$5,984	\$6,265	\$6,502
	* 48 x 144 x 29	(3) Flat CAP Bases	CFC48144BR	\$5,056	\$5,355	\$5,608
	* 60 x 144 x 29	(3) Flat CAP Bases	CFC60144BR	\$6,337	\$6,654	\$6,923
	* 48 x 168 x 29	(4) Flat CAP Bases	CFC48168BR	\$6,434	\$6,768	\$7,050
	* 60 x 168 x 29	(4) Flat CAP Bases	CFC60168BR	\$7,965	\$8,320	\$8,621
OVAL SHAPE TOP (OV)						
	42 x 84 x 29	(2) Flat CAP Bases	CFC4284OV	\$3,110	\$3,267	\$3,315
	42 x 96 x 29	(2) Flat CAP Bases	CFC4296OV	\$3,267	\$3,443	\$3,497
	48 x 96 x 29	(2) Flat CAP Bases	CEC4896OV	\$3,338	\$3,519	\$3,575
	* 48 x 120 x 29	(3) Flat CAP Bases	CFC48120OV	\$4,792	\$5,008	\$5,190
	* 60 x 120 x 29	(3) Flat CAP Bases	CFC60120OV	\$5,984	\$6,209	\$6,400
	* 48 x 144 x 29	(3) Flat CAP Bases	CFC48144OV	\$5,056	\$5,306	\$5,518
	* 60 x 144 x 29	(3) Flat CAP Bases	CFC60144OV	\$6,337	\$6,605	\$6,832
	* 48 x 168 x 29	(4) Flat CAP Bases	CFC48168OV	\$6,434	\$6,758	\$7,033
	* 60 x 168 x 29	(4) Flat CAP Bases	CFC60168OV	\$7,965	\$8,309	\$8,599



HPL TOPS | 44 standard HPL finishes

METAL BASES | 11 powder coat finishes

EDGES | matching & coordinating finishes in the following options:

ABS 1: PVC-free impact resistant flat edge (S)

ABS 2: Multi-Ply "Plywood Look" flat vinyl edge (M)

ABS 3: Knife (KV), 1/2" Flat edge- bevel painted in a companion color

- Refer to edge code, above in (), when pricing below -

Standard Features:

- Adjustable leveling glides included.
- Power/Data options available, see Power/Data Solutions page.
- Wire management, grommets, etc. available, consult factory.

(*) Refers to a 2-Piece Top. Spline and Joint Fasteners included with table.

NOTE: Woodgrain pattern alignment between two tops not guaranteed.

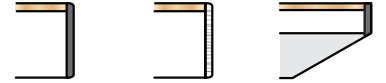

	SIZE	BASE INFO #, Style	MODEL #	ABS 1 S	ABS 2 M	ABS 3 KV
RECTANGLE SHAPE TOP (SQ)						
	42 x 84 x 29	(2) Elip. CAP Bases	CEC4284SQ	\$2,928	\$3,137	\$3,201
	42 x 96 x 29	(2) Elip. CAP Bases	CEC4296SQ	\$3,062	\$3,287	\$3,356
	48 x 96 x 29	(2) Elip. CAP Bases	CEC4896SQ	\$3,099	\$3,324	\$3,393
	* 48 x 120 x 29	(3) Elip. CAP Bases	CEC48120SQ	\$4,496	\$4,757	\$4,979
	* 60 x 120 x 29	(3) Elip. CAP Bases	CEC60120SQ	\$5,617	\$5,897	\$6,134
	* 48 x 144 x 29	(3) Elip. CAP Bases	CEC48144SQ	\$4,701	\$5,000	\$5,253
	* 60 x 144 x 29	(3) Flat CAP Bases	CEC60144SQ	\$5,894	\$6,211	\$6,480
	* 48 x 168 x 29	(4) Elip. CAP Bases	CEC48168SQ	\$6,021	\$6,355	\$6,638
	* 60 x 168 x 29	(4) Elip. CAP Bases	CEC60168SQ	\$7,448	\$7,803	\$8,104
WEDGE SHAPE TOP (WD)						
	42 x 84 x 29	(2) Elip. CAP Bases	CEC4284WD	\$3,060	\$3,268	\$3,333
	42 x 96 x 29	(2) Elip. CAP Bases	CEC4296WD	\$3,213	\$3,437	\$3,506
	48 x 96 x 29	(2) Elip. CAP Bases	CEC4896WD	\$3,270	\$3,495	\$3,564
	* 48 x 120 x 29	(3) Elip. CAP Bases	CEC48120WD	\$4,712	\$4,973	\$5,195
	* 60 x 120 x 29	(3) Elip. CAP Bases	CEC60120WD	\$5,885	\$6,165	\$6,402
	* 48 x 144 x 29	(3) Elip. CAP Bases	CEC48144WD	\$4,959	\$5,258	\$5,511
	* 60 x 144 x 29	(3) Elip. CAP Bases	CEC60144WD	\$6,215	\$6,533	\$6,802
	* 48 x 168 x 29	(4) Elip. CAP Bases	CEC48168WD	\$6,323	\$6,657	\$6,939
* 60 x 168 x 29	(4) Elip. CAP Bases	CEC60168WD	\$7,824	\$8,179	\$8,479	
BOAT SHAPE TOP (BT)						
	42 x 84 x 29	(2) Elip. CAP Bases	CEC4284BT	\$3,093	\$3,302	\$3,366
	42 x 96 x 29	(2) Elip. CAP Bases	CEC4296BT	\$3,250	\$3,474	\$3,543
	48 x 96 x 29	(2) Elip. CAP Bases	CEC4896BT	\$3,314	\$3,538	\$3,607
	* 48 x 120 x 29	(3) Elip. CAP Bases	CEC48120BT	\$4,765	\$5,027	\$5,248
	* 60 x 120 x 29	(3) Elip. CAP Bases	CEC60120BT	\$5,951	\$6,231	\$6,469
	* 48 x 144 x 29	(3) Elip. CAP Bases	CEC48144BT	\$5,023	\$5,322	\$5,575
	* 60 x 144 x 29	(3) Elip. CAP Bases	CEC60144BT	\$6,296	\$6,613	\$6,882
	* 48 x 168 x 29	(4) Elip. CAP Bases	CEC48168BT	\$6,397	\$6,731	\$7,013
* 60 x 168 x 29	(4) Elip. CAP Bases	CEC60168BT	\$7,918	\$8,273	\$8,574	



HPL TOPS | 44 standard HPL finishes

METAL BASES | 11 powder coat finishes

EDGES | matching & coordinating finishes in the following options:

ABS 1: PVC-free impact resistant flat edge (S)

ABS 2: Multi-Ply "Plywood Look" flat vinyl edge (M)

ABS 3: Knife (KV), 1/2" Flat edge- bevel painted in a companion color

- Refer to edge code, above in (), when pricing below -

Standard Features:

- Adjustable leveling glides included.
- Power/Data options available, see Power/Data Solutions page.
- Wire management, grommets, etc. available, consult factory.

(*) Refers to a 2-Piece Top. Spline and Joint Fasteners included with table.

NOTE: Woodgrain pattern alignment between two tops not guaranteed.

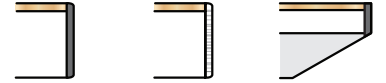

SIZE	BASE INFO #, Style	MODEL #	ABS 1 S	ABS 2 M	ABS 3 KV	
DIAMOND SHAPE TOP (DM)						
	42 x 84 x 29	(2) Elip. CAP Bases	CEC4284DM	\$3,093	\$3,302	\$3,366
	42 x 96 x 29	(2) Elip. CAP Bases	CEC4296DM	\$3,250	\$3,474	\$3,543
	48 x 96 x 29	(2) Elip. CAP Bases	CEC4896DM	\$3,314	\$3,538	\$3,607
	* 48 x 120 x 29	(3) Elip. CAP Bases	CEC48120DM	\$4,765	\$5,027	\$5,248
	* 60 x 120 x 29	(3) Elip. CAP Bases	CEC60120DM	\$5,951	\$6,231	\$6,469
	* 48 x 144 x 29	(3) Elip. CAP Bases	CEC48144DM	\$5,023	\$5,322	\$5,575
	* 60 x 144 x 29	(3) Elip. CAP Bases	CEC60144DM	\$6,296	\$6,613	\$6,882
	* 48 x 168 x 29	(4) Elip. CAP Bases	CEC48168DM	\$6,397	\$6,731	\$7,013
	* 60 x 168 x 29	(4) Elip. CAP Bases	CEC60168DM	\$7,918	\$8,273	\$8,574
BULLET SHAPE TOP (BU)						
	42 x 84 x 29	(2) Elip. CAP Bases	CEC4284BU	\$3,093	\$3,275	\$3,331
	42 x 96 x 29	(2) Elip. CAP Bases	CEC4296BU	\$3,250	\$3,451	\$3,513
	48 x 96 x 29	(2) Elip. CAP Bases	CEC4896BU	\$3,314	\$3,522	\$3,587
	* 48 x 120 x 29	(3) Elip. CAP Bases	CEC48120BU	\$4,765	\$5,011	\$5,219
	* 60 x 120 x 29	(3) Elip. CAP Bases	CEC60120BU	\$5,951	\$6,216	\$6,440
	* 48 x 144 x 29	(3) Elip. CAP Bases	CEC48144BU	\$5,023	\$5,306	\$5,546
	* 60 x 144 x 29	(3) Elip. CAP Bases	CEC60144BU	\$6,296	\$6,598	\$6,853
	* 60 x 168 x 29	(4) Elip. CAP Bases	CEC48168BU	\$6,397	\$6,717	\$6,989
BOW END SHAPE TOP (BE)						
	42 x 84 x 29	(2) Elip. CAP Bases	CEC4284BE	\$3,093	\$3,302	\$3,366
	42 x 96 x 29	(2) Elip. CAP Bases	CEC4296BE	\$3,250	\$3,474	\$3,543
	48 x 96 x 29	(2) Elip. CAP Bases	CEC4896BE	\$3,314	\$3,538	\$3,607
	* 48 x 120 x 29	(3) Elip. CAP Bases	CEC48120BE	\$4,765	\$5,027	\$5,248
	* 60 x 120 x 29	(3) Elip. CAP Bases	CEC60120BE	\$5,951	\$6,231	\$6,469
	* 48 x 144 x 29	(3) Elip. CAP Bases	CEC48144BE	\$5,023	\$5,322	\$5,575
	* 60 x 144 x 29	(3) Elip. CAP Bases	CEC60144BE	\$6,296	\$6,613	\$6,882
	* 48 x 168 x 29	(4) Elip. CAP Bases	CEC48168BE	\$6,397	\$6,731	\$7,013
* 60 x 168 x 29	(4) Elip. CAP Bases	CEC60168BE	\$7,918	\$8,273	\$8,574	



HPL TOPS | 44 standard HPL finishes

METAL BASES | 11 powder coat finishes

EDGES | matching & coordinating finishes in the following options:

ABS 1: PVC-free impact resistant flat edge (S)

ABS 2: Multi-Ply "Plywood Look" flat vinyl edge (M)

ABS 3: Knife (KV), 1/2" Flat edge- bevel painted in a companion color

- Refer to edge code, above in (), when pricing below -

Standard Features:

- Adjustable leveling glides included.
- Power/Data options available, see Power/Data Solutions page.
- Wire management, grommets, etc. available, consult factory.

(*) Refers to a 2-Piece Top. Spline and Joint Fasteners included with table.

NOTE: Woodgrain pattern alignment between two tops not guaranteed.

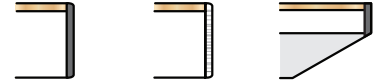

	SIZE	BASE INFO #, Style	MODEL #	ABS 1 S	ABS 2 M	ABS 3 KV
RACETRACK SHAPE TOP (RT)						
	42 x 84 x 29	(2) Elip. CAP Bases	CEC4284RT	\$3,110	\$3,278	\$3,329
	42 x 96 x 29	(2) Elip. CAP Bases	CEC4296RT	\$3,267	\$3,453	\$3,511
	48 x 96 x 29	(2) Elip. CAP Bases	CEC4896RT	\$3,338	\$3,531	\$3,591
	* 48 x 120 x 29	(3) Elip. CAP Bases	CEC48120RT	\$4,792	\$5,022	\$5,217
	* 60 x 120 x 29	(3) Elip. CAP Bases	CEC60120RT	\$5,984	\$6,233	\$6,444
	* 48 x 144 x 29	(3) Elip. CAP Bases	CEC48144RT	\$5,056	\$5,324	\$5,551
	* 60 x 144 x 29	(3) Elip. CAP Bases	CEC60144RT	\$6,337	\$6,623	\$6,866
	* 48 x 168 x 29	(4) Elip. CAP Bases	CEC48168RT	\$6,434	\$6,738	\$6,996
	* 60 x 168 x 29	(4) Elip. CAP Bases	CEC60168RT	\$7,965	\$8,288	\$8,562
BOAT ROUNDED SHAPE TOP (BR)						
	42 x 84 x 29	(2) Elip. CAP Bases	CEC4284BR	\$3,110	\$3,318	\$3,382
	42 x 96 x 29	(2) Elip. CAP Bases	CEC4296BR	\$3,267	\$3,491	\$3,560
	48 x 96 x 29	(2) Elip. CAP Bases	CEC4896BR	\$3,338	\$3,562	\$3,631
	* 48 x 120 x 29	(3) Elip. CAP Bases	CEC48120BR	\$4,792	\$5,054	\$5,275
	* 60 x 120 x 29	(3) Elip. CAP Bases	CEC60120BR	\$5,984	\$6,265	\$6,502
	* 48 x 144 x 29	(3) Elip. CAP Bases	CEC48144BR	\$5,056	\$5,355	\$5,608
	* 60 x 144 x 29	(3) Elip. CAP Bases	CEC60144BR	\$6,337	\$6,654	\$6,923
	* 60 x 168 x 29	(4) Elip. CAP Bases	CEC60168BR	\$6,434	\$6,768	\$7,050
OVAL SHAPE TOP (OV)						
	42 x 84 x 29	(2) Elip. CAP Bases	CEC4284OV	\$3,110	\$3,267	\$3,315
	42 x 96 x 29	(2) Elip. CAP Bases	CEC4296OV	\$3,267	\$3,443	\$3,497
	48 x 96 x 29	(2) Elip. CAP Bases	CEC4896OV	\$3,338	\$3,519	\$3,575
	* 48 x 120 x 29	(3) Elip. CAP Bases	CEC48120OV	\$4,792	\$5,008	\$5,190
	* 60 x 120 x 29	(3) Elip. CAP Bases	CEC60120OV	\$5,984	\$6,209	\$6,400
	* 48 x 144 x 29	(3) Elip. CAP Bases	CEC48144OV	\$5,056	\$5,306	\$5,518
	* 60 x 144 x 29	(3) Elip. CAP Bases	CEC60144OV	\$6,337	\$6,605	\$6,832
	* 48 x 168 x 29	(4) Elip. CAP Bases	CEC48168OV	\$6,434	\$6,758	\$7,033
* 60 x 168 x 29	(4) Elip. CAP Bases	CEC60168OV	\$7,965	\$8,309	\$8,599	



OCCASIONAL TABLES



HPL TOPS | 44 standard HPL finishes

EDGES | matching & coordinating finishes in the following options:

ABS 1: PVC-free impact resistant flat edge (S)

ABS 2: Multi-Ply "Plywood Look" flat vinyl edge (M)



ABS 3: Knife (KV), 1/2" Flat edge- bevel painted in a companion color

- Refer to edge code, above in (), when pricing below -

Standard Features:

- Adjustable leveling glides included.
- Power/Data options available, consult factory.

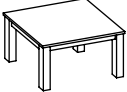

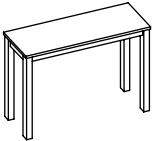
SIZE	BASE INFO #, Style	MODEL #	ABS 1 S	ABS 2 M	ABS 3 KV	
SQUARE TOP SIDE TABLE 22" H.						
	18 x 18 x 22	(4) Post Legs, 3" aprons	OPSE181822	\$963	\$1,019	\$1,036
	24 x 24 x 22	(4) Post Legs, 3" aprons	OPSE242422	\$1,023	\$1,098	\$1,121
	30 x 30 x 22	(4) Post Legs, 3" aprons	OPSE303022	\$1,120	\$1,213	\$1,242
SQUARE TOP COFFEE TABLE 17" H.						
	36 x 36 x 17	(4) Post Legs, 3" aprons	OPSC363617	\$1,165	\$1,277	\$1,312
	48 x 48 x 17	(4) Post Legs, 3" aprons	OPSC484817	\$1,371	\$1,521	\$1,567
RECTANGLE TOP COFFEE TABLE 17" H.						
	24 x 48 x 17	(4) Post Legs, 3" aprons	OPSC244817	\$1,135	\$1,247	\$1,281
RECTANGLE TOP CONSOLE TABLE 34" H.						
	20 x 48 x 34	(4) Post Legs, 3" aprons	OPSCO204834	\$1,379	\$1,485	\$1,517



HPL TOPS | 44 standard HPL finishes

EDGES | matching & coordinating finishes in the following options:

ABS 1: PVC-free impact resistant flat edge (S)

ABS 2: Multi-Ply "Plywood Look" flat vinyl edge (M)

KICKBASE | Optional Black 1-1/4" recessed (-KB) on select models

- Refer to edge code, above in (), when pricing below -

Standard Features:

- Adjustable leveling glides included.
- 1/4" black reveal
- Power/Data options available, consult factory.
- Solid Surface Top option available, consult factory.

(*) Refers to an Oval Shaped Table.

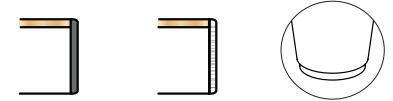

SIZE	BASE INFO #, Style	MODEL #	ABS 1 S	ABS 2 M	Kickbase -KB	
TAPERED CYLINDER TABLES						
END TABLES 22" HIGH						
	18" Dia. x 22	Tapered Drum	709-1822	\$1,407	\$1,451	\$76
	20" Dia. x 22	Tapered Drum	709-2122	\$1,552	\$1,601	\$85
	24" Dia. x 22	Tapered Drum	709-2422	\$1,611	\$1,670	\$95
COFFEE TABLES 17" HIGH						
	36" Dia. x 17	Tapered Drum	709-3617	\$2,007	\$2,095	\$124
	42" Dia. x 17	Tapered Drum	709-4217	\$2,458	\$2,561	\$144
	* 34 x 21 x 17	Tapered Drum	709-342117	\$2,019	\$2,105	\$119
CYLINDER TABLES						
END TABLES 22" HIGH						
	18" Dia. x 22	Straight Drum	710-1822	\$882	\$926	\$76
	20" Dia. x 22	Straight Drum	710-2122	\$1,078	\$1,127	\$85
	24" Dia. x 22	Straight Drum	710-2422	\$1,129	\$1,187	\$95
COFFEE TABLES 17" HIGH						
	36" Dia. x 17	Straight Drum	710-3617	\$1,525	\$1,613	\$124
	42" Dia. x 17	Straight Drum	710-4217	\$1,905	\$2,008	\$144
	* 34 x 21 x 17	Straight Drum	710-342117	\$1,442	\$1,528	\$119
FLOATING CYLINDER TABLES						
END TABLES 24" HIGH						
	18" Dia. x 24	Straight Floating Base	711-1824	\$957	\$1,001	-
	20" Dia. x 24	Straight Floating Base	711-2124	\$1,164	\$1,213	-
	24" Dia. x 24	Straight Floating Base	711-2424	\$1,223	\$1,282	-
COFFEE TABLES 17" HIGH						
	36" Dia. x 17	Straight Floating Base	711-3617	\$1,649	\$1,737	-
	42" Dia. x 17	Straight Floating Base	711-4217	\$2,049	\$2,152	-
	* 34 x 21 x 17	Straight Floating Base	711-342117	\$1,560	\$1,646	-



ALL HPL SURFACES | 44 standard HPL finishes

No edge profiles available for the Cube Series Tables

FLOATING CUBE OPTION | Matching 3" high recessed kickbase

Standard Features:

- Adjustable leveling glides
- Power/Data options available, consult factory.

SIZE	BASE INFO #, Style	MODEL #	TABLE PRICE	
STRAIGHT CUBE				
SQUARE END TABLES 22" HIGH				
	18 x 18 x 22	Cube	OCSE181822	\$594
	24 x 24 x 22	Cube	OCSE242422	\$653
	30 x 30 x 22	Cube	OCSE303022	\$750
SQUARE COFFEE TABLES 17" HIGH				
	36 x 36 x 17	Cube	OCSC363617	\$838
	48 x 48 x 17	Cube	OCSC484817	\$990
RECTANGLE COFFEE TABLE 17" HIGH				
	24 x 48 x 17	Cube	OCSC244817	\$754
FLOATING CUBE				
SQUARE END TABLES 22" HIGH				
	18 x 18 x 22	3" Kickbase in matching HPL	OFCSE181822	\$808
	24 x 24 x 22	3" Kickbase in matching HPL	OFCSE242422	\$872
	30 x 30 x 22	3" Kickbase in matching HPL	OFCSE303022	\$981
SQUARE COFFEE TABLES 17" HIGH				
	36 x 36 x 17	3" Kickbase in matching HPL	OFCSC363617	\$1,078
	48 x 48 x 17	3" Kickbase in matching HPL	OFCSC484817	\$1,261
RECTANGLE COFFEE TABLE 17" HIGH				
	24 x 48 x 17	3" Kickbase in matching HPL	OFCSC244817	\$1,013



HPL TOPS | 44 standard HPL finishes

EDGES | matching & coordinating finishes in the following options:

ABS 1: PVC-free impact resistant flat edge (S)

ABS 2: Multi-Ply "Plywood Look" flat vinyl edge (M)

STYLES | kickbase or metal leg models

- Refer to edge code, above in (), when pricing below -

Standard Features:

- Adjustable leveling glides
- Impact resistant edgbanding
- Power/Data options available, consult factory.
- Solid Surface Top option available, consult factory.

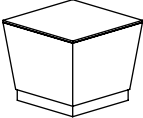
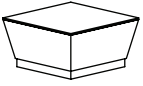
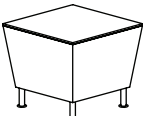
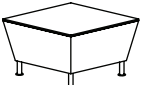

SIZE	BASE INFO #, Style	MODEL #	ABS 1 S	ABS 2 M	
TAPERED CUBE TABLES WITH 1-1/4" BLACK RECESSED KICKBASE					
END TABLES 22" HIGH					
	18 x 18 x 22	1-1/4" Black Kickbase	OTCSE181822	\$1,012	\$1,068
	24 x 24 x 22	1-1/4" Black Kickbase	OTCSE242422	\$1,118	\$1,193
	30 x 30 x 22	1-1/4" Black Kickbase	OTCSE303022	\$1,227	\$1,321
COFFEE TABLES 17" HIGH					
	36 x 36 x 17	1-1/4" Black Kickbase	OTCSC363617	\$1,363	\$1,476
	48 x 48 x 17	1-1/4" Black Kickbase	OTCSC484817	\$1,589	\$1,738
	* 24 x 48 x 17	1-1/4" Black Kickbase	OTCSC244817	\$1,299	\$1,411
TAPERED CUBE TABLES WITH METAL LEGS 3 LEG OPTIONS: L1,L2, L3 (see below)					
END TABLES 22" HIGH					
	18 x 18 x 22	(4) Decorative Metal Legs	OTCMSE181822	\$1,091	\$1,147
	24 x 24 x 22	(4) Decorative Metal Legs	OTCMSE242422	\$1,197	\$1,272
	30 x 30 x 22	(4) Decorative Metal Legs	OTCMSE303022	\$1,306	\$1,399
COFFEE TABLES 17" HIGH					
	36 x 36 x 17	(4) Decorative Metal Legs	OTCMSC363617	\$1,442	\$1,554
	48 x 48 x 17	(4) Decorative Metal Legs	OTCMSC484817	\$1,668	\$1,817
	24 x 48 x 17	(4) Decorative Metal Legs	OTCMSC244817	\$1,378	\$1,490

Available Metal Leg Options:

L1 - Round Post Contemporary
Silver Aluminum Finish



L2 - Round Contemporary
Silver Aluminum Finish



L3 - Square Contemporary
Silver Aluminum Finish

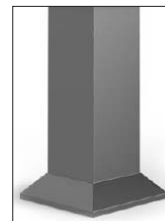

- Select a leg style above, add the suffix **L1**, **L2**, or **L3** to the model number: *Example:* OTCMSE181822-L3
- All legs are approximately 4" - 6" high, +/- 1/2" depending on leg option.
- All leg options are the same price.



ALL HPL SURFACES | 44 standard HPL finishes

- No edge profiles available for the Cube Series Tables
- 2-1/2" thick Top and Panel Legs

Standard Features:

- Adjustable leveling glides included.
- Power/Data options available, consult factory.

(*) Refers to a Rectangle Shaped Table.

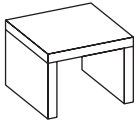
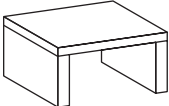
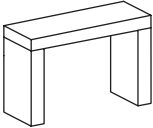
SIZE	<u>BASE INFO</u> #, Style	MODEL #	TABLE PRICE	
END TABLES 22" HIGH				
	18 x 18 x 22	(2) Panel Style Legs	OPESE181822	\$808
	24 x 24 x 22	(2) Panel Style Legs	OPESE242422	\$1,188
	30 x 30 x 22	(2) Panel Style Legs	OPESE303022	\$1,327
COFFEE TABLES 17" HIGH				
	36 x 36 x 17	(2) Panel Style Legs	OPESC363617	\$1,350
	48 x 48 x 17	(2) Panel Style Legs	OPESC484817	\$1,665
	* 24 x 48 x 17	(2) Panel Style Legs	OPESC244817	\$1,304
SOFA TABLES 29" HIGH				
	20 x 48 x 29	(2) Panel Style Legs	OPESCO204829	\$1,445



HPL TOPS | 44 standard HPL finishes

EDGES | matching & coordinating finishes in the following options:

ABS 1: PVC-free impact resistant flat edge (S)

ABS 2: Multi-Ply "Plywood Look" flat vinyl edge (M)

Standard Features:

- 1/4" black reveal
- Decorative metal legs. Three styles available, see below.
- Power/Data options available, consult factory.
- Solid Surface Top option available, consult factory.

- Refer to edge code, above in (), when pricing below -

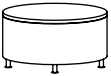

SIZE	BASE INFO #, Style	MODEL #	ABS 1 S	ABS 2 M
END TABLES 22" HIGH				
 ROUND 18" Dia. x 22 24" Dia. x 22	(4) Decorative Metal Legs	OMLRE1822	\$1,145	\$1,189
	(4) Decorative Metal Legs	OMLRE2422	\$1,391	\$1,450
 SQUARE 18 x 18 x 22 24 x 24 x 22	(4) Decorative Metal Legs	OMLSE181822	\$1,057	\$1,113
	(4) Decorative Metal Legs	OMLSE242422	\$1,164	\$1,239
COFFEE TABLES 17" HIGH				
 ROUND 36" Dia. x 17 42" Dia. x 17	(4) Decorative Metal Legs	OMLRC3617	\$1,474	\$1,562
	(4) Decorative Metal Legs	OMLRC4217	\$2,104	\$2,207
 SQUARE 36 x 36 x 17 48 x 48 x 17	(4) Decorative Metal Legs	OMLSC363617	\$1,531	\$1,643
	(4) Decorative Metal Legs	OMLSC484817	\$1,864	\$2,014

Available Metal Leg Options:

L1 - Round Post Contemporary
Silver Aluminum Finish



L2 - Round Contemporary
Silver Aluminum Finish



L3 - Square Contemporary
Silver Aluminum Finish

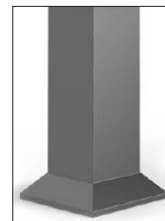

- Select a leg style above, add the suffix L1, L2, or L3 to the model number: Example: OMLRE1822-L3
- All legs are approximately 4" - 6" high, +/- 1/2" depending on leg option.
- All leg options are the same price.



HUDSON SERIES

Overview131

Accessories132

TABLE PRICING, Shop By Height:

Seated Height- 29"133

Counter Height- 36"134

Standing Height- 42"135

Inspired by the classic Parsons design, this modernist style table works fluently within commercial applications, educational environments & beyond.



Base Specifications | SEATED 29", COUNTER 36", STANDING 42" (HEIGHTS INCLUDE CASTERS- IF SELECTED)

- 11 standard powdercoat finishes *(more details on page 7)*
- 2 1/2" Square Legs, Leveling Glides Included
- 2" High Aprons
- 4 legs Apply to Lengths 96" & Less
- 6 legs Apply to 108", 120", 144" Lengths

Surface Specifications | SQUARE & RECTANGLE SHAPES

- 44 Standard HPL Finishes
- 3 Edge Options
- Top Thickness 1-1/4" +/- based on edge detail.
- 1 Piece Tops Apply to Lengths 96" & Less
- 2 Piece Tops Apply to 108", 120", 144" Lengths.
(Alignment of woodgrain patterns with 2 piece tops cannot be guaranteed, draw-tight hardware & wafers are included for installation)
- Power/Data Options: PPD- 5, 10, 30, 50, 70, 80, 90, 120, 130
For All Unit Details See the Power/Data Solutions Section

See "Primeway Standard Color Card" for All Finish Specifications & Swatches

Model#	Accessory Option	List Price
RWG	Rectangular Grommet	\$25
TFG	Round Grommet	\$25
AWM12	Wire Management Channel 12"	\$42
AWM16	Wire Management Channel 16"	\$48
AWM24	Wire Management Channel 24"	\$66
AWM42	Wire Management Channel 42"	\$89
AWM54	Wire Management Channel 54"	\$118
AWM66	Wire Management Channel 66"	\$144
CGWM	Cable Grip Wire Management	\$18
CMT	Cable Management Tray	\$260
MWM-B	Magnetic Wire Management, Black	\$68
MWM-S	Magnetic Wire Management, Silver	\$68
WMH	(2) Wire Management Holes- per leg	\$75
UBH	Under Mount Bag/Coat Hook	\$35
CASTI-4	(4) 3 1/2" Industrial Casters	\$200
CASTI-6	(6) 3 1/2" Industrial Casters	\$300



- 3 1/2" L x 2 1/8" W Rectangle, Black Plastic
- 2 Piece Removable Top with Center Hole
- Requires a 3/4" x 1 7/8" hole



- 3" Round, Black Plastic
- 1 Piece with Wire Access
- Requires a 2 3/8" Diameter Hole

Factory cut hole to specified location, can also be field installed by other.

- 1 9/16" W x 1 1/4" D, Black PVC
- 6 Length Options
- Attaches to the Underside of the Top with Double Sided Tape & 2 Screws- *provided*



- 3 1/2" L x 2 1/2" W x 1 1/4" D, Black Plastic
- Cord Snaps in Loops
- Attaches to the Underside of the Top with Screws- *provided*

- 15" L x 8" W x 4" D
- Metal, Black Wrinkle
- Attaches to the Underside of the Top with Screws- *provided*



- 17 3/4" L x 2" W x 1" D
- Interchangeable on Leg Surface
- Black or Silver Metal

- 1 1/4" holes: 2 per leg
- Leg Location: Inside Top & Bottom

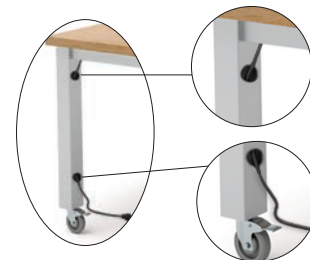

- 1-Hook, Screws & Pre-Drilled Holes
- Specify Location When Ordering
- Mounted about 2 1/2" back from table edge, on wooden block, flush with underside of apron. (*unless specified otherwise*)
- Black Metal



- 3 1/2"
- Grey/Locking Wheel
- Silver Metal



NOTE: Casters eliminate leveling & high spots in the floor could cause the table to become unbalanced & should be used with caution, especially on tables with 6 legs.

HUDSON SERIES | SEATED 29"



HPL TOPS | 44 standard HPL finishes

METAL BASES | 11 powder coat finishes

EDGES | matching & coordinating finishes in the following options:

ABS 1: PVC-free impact resistant flat edge (S)

ABS 2: Multi-Ply "Plywood Look" flat vinyl edge (M)

ABS 3: Knife (KV), 1/2" Flat edge- bevel painted in a companion color

- Refer to edge code, above in (), when pricing below -

*FOR KNIFE EDGE OPTIONS ON THIS SERIES: The bevel degree is slightly less than shown to accommodate base style.

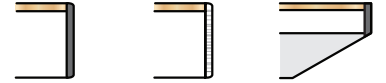

	SIZE	BASE INFO #, Style	MODEL #	ABS 1 S	ABS 2 M	ABS 3 KV
SEATED HEIGHT 29"						
	24 x 24 x 29	(4) 2.5" legs	HT242429	\$1,144	\$1,221	\$1,244
	24 x 36 x 29	(4) 2.5" legs	HT243629	\$1,265	\$1,360	\$1,389
	24 x 42 x 29	(4) 2.5" legs	HT244229	\$1,328	\$1,433	\$1,466
	24 x 48 x 29	(4) 2.5" legs	HT244829	\$1,356	\$1,470	\$1,505
	24 x 60 x 29	(4) 2.5" legs	HT246029	\$1,388	\$1,521	\$1,561
	24 x 72 x 29	(4) 2.5" legs	HT247229	\$1,435	\$1,586	\$1,633
	30 x 30 x 29	(4) 2.5" legs	HT303029	\$1,259	\$1,354	\$1,384
	30 x 36 x 29	(4) 2.5" legs	HT303629	\$1,311	\$1,415	\$1,447
	30 x 42 x 29	(4) 2.5" legs	HT304229	\$1,384	\$1,497	\$1,532
	30 x 48 x 29	(4) 2.5" legs	HT304829	\$1,408	\$1,531	\$1,623
	30 x 60 x 29	(4) 2.5" legs	HT306029	\$1,463	\$1,604	\$1,648
	30 x 72 x 29	(4) 2.5" legs	HT307229	\$1,549	\$1,709	\$1,758
	30 x 84 x 29	(4) 2.5" legs	HT308429	\$1,720	\$1,900	\$2,233
	30 x 96 x 29	(4) 2.5" legs	HT309629	\$1,999	\$2,197	\$3,326
	30 x 120 x 29	(6) 2.5" legs	HT3012029	\$3,067	\$3,303	\$3,624
	30 x 144 x 29	(6) 2.5" legs	HT3014429	\$3,317	\$3,589	\$3,673
	36 x 36 x 29	(4) 2.5" legs	HT363629	\$1,375	\$1,489	\$1,524
	36 x 42 x 29	(4) 2.5" legs	HT364229	\$1,435	\$1,558	\$1,652
	36 x 48 x 29	(4) 2.5" legs	HT364829	\$1,491	\$1,623	\$1,748
	36 x 60 x 29	(4) 2.5" legs	HT366029	\$1,575	\$1,726	\$1,887
	36 x 72 x 29	(4) 2.5" legs	HT367229	\$1,689	\$1,859	\$1,911
	36 x 84 x 29	(4) 2.5" legs	HT368429	\$1,937	\$2,126	\$2,184
	36 x 96 x 29	(4) 2.5" legs	HT369629	\$2,009	\$2,216	\$2,279
	36 x 120 x 29	(6) 2.5" legs	HT3612029	\$3,213	\$3,458	\$3,804
	36 x 144 x 29	(6) 2.5" legs	HT3614429	\$3,485	\$3,767	\$3,854
	42 x 42 x 29	(4) 2.5" legs	HT424229	\$1,466	\$1,598	\$1,814
	42 x 48 x 29	(4) 2.5" legs	HT424829	\$1,641	\$1,782	\$1,826
	42 x 60 x 29	(4) 2.5" legs	HT426029	\$1,696	\$1,857	\$1,906
	42 x 72 x 29	(4) 2.5" legs	HT427229	\$1,778	\$1,957	\$2,012
	42 x 84 x 29	(4) 2.5" legs	HT428429	\$1,907	\$2,105	\$2,165
	42 x 96 x 29	(4) 2.5" legs	HT429629	\$1,961	\$2,178	\$2,244
	42 x 108 x 29	(4) 2.5" legs	HT4210829	\$3,205	\$3,440	\$3,513
	42 x 120 x 29	(6) 2.5" legs	HT4212029	\$3,481	\$3,735	\$3,813
	42 x 144 x 29	(6) 2.5" legs	HT4214429	\$3,787	\$4,078	\$4,167
	48 x 48 x 29	(4) 2.5" legs	HT484829	\$1,616	\$1,767	\$1,814
	48 x 60 x 29	(4) 2.5" legs	HT486029	\$1,788	\$1,958	\$2,010
	48 x 72 x 29	(4) 2.5" legs	HT487229	\$1,911	\$2,100	\$2,158
	48 x 84 x 29	(4) 2.5" legs	HT488429	\$1,968	\$2,175	\$2,239
	48 x 96 x 29	(4) 2.5" legs	HT489629	\$2,060	\$2,286	\$2,356
	48 x 108 x 29	(4) 2.5" legs	HT4810829	\$3,532	\$3,776	\$3,852
	48 x 120 x 29	(6) 2.5" legs	HT4812029	\$3,811	\$4,074	\$4,155
	48 x 144 x 29	(6) 2.5" legs	HT4814429	\$4,007	\$4,308	\$4,400

HUDSON SERIES | COUNTER 36"



HPL TOPS | 44 standard HPL finishes

METAL BASES | 11 powder coat finishes

EDGES | matching & coordinating finishes in the following options:

ABS 1: PVC-free impact resistant flat edge (S)

ABS 2: Multi-Ply "Plywood Look" flat vinyl edge (M)

ABS 3: Knife (KV), 1/2" Flat edge- bevel painted in a companion color

- Refer to edge code, above in (), when pricing below -

*FOR KNIFE EDGE OPTIONS ON THIS SERIES: The bevel degree is slightly less than shown to accommodate base style.



	SIZE	BASE INFO #, Style	MODEL #	ABS 1 S	ABS 2 M	ABS 3 KV
COUNTER HEIGHT 36"						
	24 x 24 x 36	(4) 2.5" legs	HT242436	\$1,275	\$1,352	\$1,375
	24 x 36 x 36	(4) 2.5" legs	HT243636	\$1,349	\$1,444	\$1,473
	24 x 42 x 36	(4) 2.5" legs	HT244236	\$1,412	\$1,518	\$1,606
	24 x 48 x 36	(4) 2.5" legs	HT244836	\$1,423	\$1,537	\$1,572
	24 x 60 x 36	(4) 2.5" legs	HT246036	\$1,473	\$1,605	\$1,646
	24 x 72 x 36	(4) 2.5" legs	HT247236	\$1,519	\$1,670	\$1,717
	30 x 30 x 36	(4) 2.5" legs	HT303036	\$1,344	\$1,439	\$1,468
	30 x 36 x 36	(4) 2.5" legs	HT303636	\$1,395	\$1,499	\$1,531
	30 x 42 x 36	(4) 2.5" legs	HT304236	\$1,468	\$1,582	\$1,678
	30 x 48 x 36	(4) 2.5" legs	HT304836	\$1,492	\$1,615	\$1,653
	30 x 60 x 36	(4) 2.5" legs	HT306036	\$1,547	\$1,689	\$1,732
	30 x 72 x 36	(4) 2.5" legs	HT307236	\$1,633	\$1,793	\$1,843
	30 x 84 x 36	(4) 2.5" legs	HT308436	\$1,788	\$1,967	\$2,022
	30 x 96 x 36	(4) 2.5" legs	HT309636	\$2,040	\$2,238	\$2,405
	30 x 120 x 36	(6) 2.5" legs	HT3012036	\$3,102	\$3,337	\$3,409
	30 x 144 x 36	(6) 2.5" legs	HT3014436	\$3,359	\$3,631	\$3,715
	36 x 36 x 36	(4) 2.5" legs	HT363636	\$1,460	\$1,573	\$1,669
	36 x 42 x 36	(4) 2.5" legs	HT364236	\$1,520	\$1,643	\$1,680
	36 x 48 x 36	(4) 2.5" legs	HT364836	\$1,575	\$1,708	\$1,748
	36 x 60 x 36	(4) 2.5" legs	HT366036	\$1,659	\$1,810	\$1,856
	36 x 72 x 36	(4) 2.5" legs	HT367236	\$1,773	\$1,943	\$1,995
	36 x 84 x 36	(4) 2.5" legs	HT368436	\$2,005	\$2,193	\$2,251
	36 x 96 x 36	(4) 2.5" legs	HT369636	\$2,050	\$2,258	\$2,321
	36 x 120 x 36	(6) 2.5" legs	HT3612036	\$3,247	\$3,492	\$3,567
	36 x 144 x 36	(6) 2.5" legs	HT3614436	\$3,527	\$3,809	\$3,896
	42 x 42 x 36	(4) 2.5" legs	HT424236	\$1,550	\$1,682	\$1,794
	42 x 48 x 36	(4) 2.5" legs	HT424836	\$1,726	\$1,868	\$1,912
	42 x 60 x 36	(4) 2.5" legs	HT426036	\$1,781	\$1,941	\$1,990
	42 x 72 x 36	(4) 2.5" legs	HT427236	\$1,862	\$2,041	\$2,096
	42 x 84 x 36	(4) 2.5" legs	HT428436	\$1,998	\$2,196	\$2,257
	42 x 96 x 36	(4) 2.5" legs	HT429636	\$2,045	\$2,262	\$2,329
	42 x 108 x 36	(4) 2.5" legs	HT4210836	\$3,293	\$3,528	\$3,600
	42 x 120 x 36	(6) 2.5" legs	HT4212036	\$3,569	\$3,823	\$3,901
	42 x 144 x 36	(6) 2.5" legs	HT4214436	\$3,863	\$4,155	\$4,401
	48 x 48 x 36	(4) 2.5" legs	HT484836	\$1,700	\$1,851	\$1,979
	48 x 60 x 36	(4) 2.5" legs	HT486036	\$1,872	\$2,042	\$2,186
	48 x 72 x 36	(4) 2.5" legs	HT487236	\$1,996	\$2,184	\$2,344
	48 x 84 x 36	(4) 2.5" legs	HT488436	\$2,053	\$2,260	\$2,323
	48 x 96 x 36	(4) 2.5" legs	HT489636	\$2,145	\$2,371	\$2,440
	48 x 108 x 36	(4) 2.5" legs	HT4810836	\$3,619	\$3,864	\$4,071
	48 x 120 x 36	(6) 2.5" legs	HT4812036	\$3,899	\$4,162	\$4,384
	48 x 144 x 36	(6) 2.5" legs	HT4814436	\$4,092	\$4,393	\$4,647

HUDSON SERIES | STANDING 42"



HPL TOPS | 44 standard HPL finishes

METAL BASES | 11 powder coat finishes

EDGES | matching & coordinating finishes in the following options:

ABS 1: PVC-free impact resistant flat edge (S)

ABS 2: Multi-Ply "Plywood Look" flat vinyl edge (M)

ABS 3: Knife (KV), 1/2" Flat edge- bevel painted in a companion color

- Refer to edge code, above in (), when pricing below -

*FOR KNIFE EDGE OPTIONS ON THIS SERIES: The bevel degree is slightly less than shown to accommodate base style.

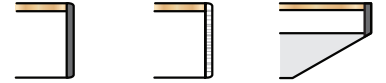

	SIZE	BASE INFO #, Style	MODEL #	ABS 1 S	ABS 2 M	ABS 3 KV
STANDING HEIGHT 42"						
	24 x 24 x 42	(4) 2.5" legs	HT242442	\$1,351	\$1,427	\$1,451
	24 x 36 x 42	(4) 2.5" legs	HT243642	\$1,425	\$1,520	\$1,549
	24 x 42 x 42	(4) 2.5" legs	HT244242	\$1,488	\$1,593	\$1,625
	24 x 48 x 42	(4) 2.5" legs	HT244842	\$1,516	\$1,630	\$1,665
	24 x 60 x 42	(4) 2.5" legs	HT246042	\$1,548	\$1,681	\$1,721
	24 x 72 x 42	(4) 2.5" legs	HT247242	\$1,595	\$1,746	\$1,792
	30 x 30 x 42	(4) 2.5" legs	HT303042	\$1,419	\$1,514	\$1,543
	30 x 36 x 42	(4) 2.5" legs	HT303642	\$1,458	\$1,562	\$1,594
	30 x 42 x 42	(4) 2.5" legs	HT304242	\$1,532	\$1,646	\$1,742
	30 x 48 x 42	(4) 2.5" legs	HT304842	\$1,561	\$1,684	\$1,788
	30 x 60 x 42	(4) 2.5" legs	HT306042	\$1,602	\$1,744	\$1,787
	30 x 72 x 42	(4) 2.5" legs	HT307242	\$1,677	\$1,837	\$1,887
	30 x 84 x 42	(4) 2.5" legs	HT308442	\$1,760	\$1,939	\$1,994
	30 x 96 x 42	(4) 2.5" legs	HT309642	\$2,126	\$2,323	\$2,384
	30 x 120 x 42	(6) 2.5" legs	HT3012042	\$3,180	\$3,415	\$3,614
	30 x 144 x 42	(6) 2.5" legs	HT3014442	\$3,438	\$3,710	\$3,941
	36 x 36 x 42	(4) 2.5" legs	HT363642	\$1,535	\$1,649	\$1,684
	36 x 42 x 42	(4) 2.5" legs	HT364242	\$1,595	\$1,718	\$1,756
	36 x 48 x 42	(4) 2.5" legs	HT364842	\$1,651	\$1,783	\$1,824
	36 x 60 x 42	(4) 2.5" legs	HT366042	\$1,734	\$1,885	\$1,932
	36 x 72 x 42	(4) 2.5" legs	HT367242	\$1,849	\$2,019	\$2,162
	36 x 84 x 42	(4) 2.5" legs	HT368442	\$2,080	\$2,269	\$2,326
	36 x 96 x 42	(4) 2.5" legs	HT369642	\$2,128	\$2,335	\$2,399
	36 x 120 x 42	(6) 2.5" legs	HT3612042	\$3,326	\$3,570	\$3,646
	36 x 144 x 42	(6) 2.5" legs	HT3614442	\$3,606	\$3,888	\$3,974
	42 x 42 x 42	(4) 2.5" legs	HT424242	\$1,625	\$1,758	\$1,798
	42 x 48 x 42	(4) 2.5" legs	HT424842	\$1,802	\$1,943	\$2,063
	42 x 60 x 42	(4) 2.5" legs	HT426042	\$1,856	\$2,016	\$2,152
	42 x 72 x 42	(4) 2.5" legs	HT427242	\$1,938	\$2,117	\$2,268
	42 x 84 x 42	(4) 2.5" legs	HT428442	\$2,073	\$2,271	\$2,439
	42 x 96 x 42	(4) 2.5" legs	HT429642	\$2,121	\$2,337	\$2,521
	42 x 108 x 42	(4) 2.5" legs	HT4210842	\$3,371	\$3,607	\$3,679
	42 x 120 x 42	(6) 2.5" legs	HT4212042	\$3,647	\$3,901	\$3,979
	42 x 144 x 42	(6) 2.5" legs	HT4214442	\$3,948	\$4,239	\$4,329
	48 x 48 x 42	(4) 2.5" legs	HT484842	\$1,776	\$1,927	\$2,055
	48 x 60 x 42	(4) 2.5" legs	HT486042	\$1,948	\$2,118	\$2,170
	48 x 72 x 42	(4) 2.5" legs	HT487242	\$2,071	\$2,260	\$2,318
	48 x 84 x 42	(4) 2.5" legs	HT488442	\$2,128	\$2,335	\$2,399
	48 x 96 x 42	(4) 2.5" legs	HT489642	\$2,220	\$2,446	\$2,637
	48 x 108 x 42	(4) 2.5" legs	HT4810842	\$3,698	\$3,943	\$4,018
	48 x 120 x 42	(6) 2.5" legs	HT4812042	\$3,977	\$4,240	\$4,321
	48 x 144 x 42	(6) 2.5" legs	HT4814442	\$4,175	\$4,475	\$4,730



VIEWPOINT SERIES

Overview	138
----------------	-----

TABLE PRICING, Shop By Shape:

Round	139
Square	140
Rounded Square	141
Soft Square.....	142
Soft Triangle	143
Bowed Triangle.....	144
Elongated Bowed Triangle.....	145
Guitar Pick.....	146
Elongated Guitar Pick	147
Soft Pentagon.....	148
Soft Wedge	149
Wedge	150
Oval	151
Squoval.....	152
Racetrack	153
D-Shape	154
Rectangle	155

This inventive design combines versatility with modern style, featuring angled, square legs that suit a variety of base configurations.

3 Heights | COCKTAIL 18", SEATED 29", STANDING 42"



2 Base Styles | "A" or "V" CONFIGURATION, SIZE & NUMBER OF LEGS VARY PER TABLE SELECTED, SEE MODEL # FOR DETAILS

- 11 powdercoat finishes
- Dependent on Table Height, Legs are 2" x 2" or 2.75" x 2.75", Leveling Glides Included

"A" Configuration

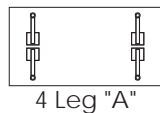

4 Leg "A"

"A" BASE | Available on 29" H models with wedge, squoval, race-track, rectangle & D-shapes.

Variations:

- 4 leg
- 6 leg (Applies to 120" & 144" lengths & require 2 piece tops)

"V" Configuration

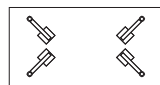

4 Leg "V"

"V" BASE | Available in all shape & height options

Variations:

- 4 leg
- 6 leg (Applies to 120" & 144" lengths & require 2 piece tops)

17 Shapes | ROUND, ELONGATED GUITAR PICK, ROUNDED SQUARE, SQUOVAL, SOFT TRIANGLE, D-SHAPE, ELONGATED BOWED TRIANGLE, SOFT WEDGE, WEDGE, GUITAR PICK, SQUARE, SOFT PENTAGON, SOFT SQUARE, RACETRACK, BOWED TRIANGLE, RECTANGLE, OVAL

- 44 Standard HPL Finishes
- 3 Edge Options
- Top Thickness 1-¼" +/- based on edge detail.
- 1 Piece Tops, Except 120" & 144" Lengths Require 2 Pieces
(Alignment of woodgrain patterns with 2 piece tops cannot be guaranteed, draw-tight hardware & wafers are included for installation)
- Stiffener Bars Included with Tables 84" & Up

See "Primeway Standard Color Card" for All Finish Specifications & Swatches



VIEWPOINT SERIES | ROUND | HEIGHTS: 18", 29", 42"



HPL TOPS | 44 standard HPL finishes

EDGES | matching & coordinating finishes in the following options:

ABS 1: PVC-free impact resistant flat edge (S)

ABS 2: Multi-Ply "Plywood Look" flat vinyl edge (M)

ABS 3: Knife (KV), 1/2" Flat edge- bevel painted in a companion color

- Refer to edge code, above in (), when pricing below -

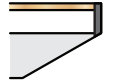

	SIZE	BASE INFO #, Style	MODEL #	ABS 1 S	ABS 2 M	ABS 3 KV
COCKTAIL HEIGHT 18"						
	30 x 18	2" - 3 - V	VRD3018	\$810	\$884	\$907
	36 x 18	2" - 3 - V	VRD3618	\$855	\$943	\$971
	42 x 18	2" - 3 - V	VRD4218	\$938	\$1,040	\$1,072
	48 x 18	2" - 3 - V	VRD4818	\$991	\$1,109	\$1,145
SEATED HEIGHT 29"						
	36 x 29	2" - 3 - V	VRD3629	\$947	\$1,035	\$1,063
	42 x 29	2" - 3 - V	VRD4229	\$1,006	\$1,109	\$1,140
	48 x 29	2" - 3 - V	VRD4829	\$1,014	\$1,132	\$1,232
	54 x 29	2 3/4" - 4 - V	VRD5429	\$1,380	\$1,513	\$1,626
	60 x 29	2 3/4" - 4 - V	VRD6029	\$1,386	\$1,533	\$1,658
STANDING HEIGHT 42"						
	42 x 42	2" - 3 - V	VRD4242	\$1,162	\$1,265	\$1,297
	48 x 42	2" - 3 - V	VRD4842	\$1,171	\$1,288	\$1,388
	54 x 42	2 3/4" - 4 - V	VRD5442	\$1,602	\$1,735	\$1,847
	60 x 42	2 3/4" - 4 - V	VRD6042	\$1,609	\$1,756	\$1,880

VIEWPOINT SERIES | SQUARE | HEIGHTS: 18", 29", 42"



HPL TOPS | 44 standard HPL finishes

EDGES | matching & coordinating finishes in the following options:

ABS 1: PVC-free impact resistant flat edge (S)

ABS 2: Multi-Ply "Plywood Look" flat vinyl edge (M)

ABS 3: Knife (KV), 1/2" Flat edge- bevel painted in a companion color

- Refer to edge code, above in (), when pricing below -

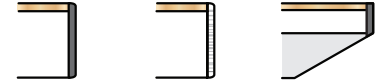

SIZE	BASE INFO #, Style	MODEL #	ABS 1 S	ABS 2 M	ABS 3 KV	
COCKTAIL HEIGHT 18"						
	30 x 30 x 18	2" - 4 - V	VS3018	\$861	\$954	\$983
	36 x 36 x 18	2" - 4 - V	VS3618	\$939	\$1,051	\$1,086
	42 x 42 x 18	2" - 4 - V	VS4218	\$1,016	\$1,128	\$1,162
	48 x 48 x 18	2" - 4 - V	VS4818	\$1,122	\$1,271	\$1,317
SEATED HEIGHT 29"						
	30 x 30 x 29	2" - 4 - V	VS3029	\$917	\$1,011	\$1,040
	36 x 36 x 29	2" - 4 - V	VS3629	\$996	\$1,108	\$1,142
	42 x 42 x 29	2" - 4 - V	VS4229	\$1,073	\$1,185	\$1,219
	48 x 48 x 29	2" - 4 - V	VS4829	\$1,121	\$1,271	\$1,397
	54 x 54 x 29	2 3/4" - 4 - V	VS5429	\$1,328	\$1,496	\$1,639
	60 x 60 x 29	2 3/4" - 4 - V	VS6029	\$1,429	\$1,616	\$1,774
STANDING HEIGHT 42"						
	36 x 36 x 42	2" - 4 - V	VS3642	\$1,256	\$1,368	\$1,402
	42 x 42 x 42	2" - 4 - V	VS4242	\$1,333	\$1,463	\$1,504
	48 x 48 x 42	2" - 4 - V	VS4842	\$1,381	\$1,531	\$1,657
	54 x 54 x 42	2 3/4" - 4 - V	VS5442	\$1,590	\$1,758	\$1,900
	60 x 60 x 42	2 3/4" - 4 - V	VS6042	\$1,688	\$1,875	\$2,033
OPTION:	3" Radius Rounded Corners	RC	\$70 (add to table price)			

VIEWPOINT SERIES | ROUNDED SQUARE | HEIGHTS: 18", 29", 42"



HPL TOPS | 44 standard HPL finishes

EDGES | matching & coordinating finishes in the following options:

ABS 1: PVC-free impact resistant flat edge (S)

ABS 2: Multi-Ply "Plywood Look" flat vinyl edge (M)

ABS 3: Knife (KV), 1/2" Flat edge- bevel painted in a companion color

- Refer to edge code, above in (), when pricing below -

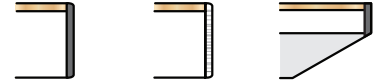

SIZE	BASE INFO #, Style	MODEL #	ABS 1 S	ABS 2 M	ABS 3 KV	
COCKTAIL HEIGHT 18"						
	30 x 30 x 18	2" - 4 - V	VRS3018	\$956	\$1,036	\$1,061
	36 x 36 x 18	2" - 4 - V	VRS3618	\$1,046	\$1,142	\$1,172
	42 x 42 x 18	2" - 4 - V	VRS4218	\$1,177	\$1,289	\$1,324
	48 x 48 x 18	2" - 4 - V	VRS4818	\$1,272	\$1,400	\$1,440
	30 x 48 x 18	2" - 4 - V	VRS304818	\$1,071	\$1,180	\$1,213
SEATED HEIGHT 29"						
	30 x 30 x 29	2" - 4 - V	VRS3029	\$966	\$1,046	\$1,071
	36 x 36 x 29	2" - 4 - V	VRS3629	\$1,056	\$1,153	\$1,182
	42 x 42 x 29	2" - 4 - V	VRS4229	\$1,188	\$1,300	\$1,334
	48 x 48 x 29	2" - 4 - V	VRS4829	\$1,282	\$1,411	\$1,519
	54 x 54 x 29	2 3/4" - 4 - V	VRS5429	\$1,544	\$1,689	\$1,811
	60 x 60 x 29	2 3/4" - 4 - V	VRS6029	\$1,636	\$1,797	\$1,932
STANDING HEIGHT 42"						
	42 x 42 x 42	2" - 4 - V	VRS4242	\$1,396	\$1,508	\$1,542
	48 x 48 x 42	2" - 4 - V	VRS4842	\$1,490	\$1,619	\$1,728
	54 x 54 x 42	2 3/4" - 4 - V	VRS5442	\$1,766	\$1,911	\$2,034
	60 x 60 x 42	2 3/4" - 4 - V	VRS6042	\$1,867	\$2,028	\$2,164

VIEWPOINT SERIES | SOFT SQUARE | HEIGHTS: 18", 29", 42"



HPL TOPS | 44 standard HPL finishes

EDGES | matching & coordinating finishes in the following options:

ABS 1: PVC-free impact resistant flat edge (S)

ABS 2: Multi-Ply "Plywood Look" flat vinyl edge (M)

ABS 3: Knife (KV), 1/2" Flat edge- bevel painted in a companion color

- Refer to edge code, above in (), when pricing below -

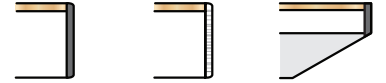

SIZE	BASE INFO #, Style	MODEL #	ABS 1 S	ABS 2 M	ABS 3 KV	
COCKTAIL HEIGHT 18"						
	30 x 30 x 18	2" - 4 - V	VSS3018	\$956	\$1,041	\$1,067
	36 x 36 x 18	2" - 4 - V	VSS3618	\$1,046	\$1,146	\$1,177
	42 x 42 x 18	2" - 4 - V	VSS4218	\$1,177	\$1,293	\$1,329
	48 x 48 x 18	2" - 4 - V	VSS4818	\$1,272	\$1,403	\$1,444
	30 x 48 x 18	2" - 4 - V	VSS304818	\$1,071	\$1,178	\$1,211
SEATED HEIGHT 29"						
	30 x 30 x 29	2" - 4 - V	VSS3029	\$974	\$1,058	\$1,085
	36 x 36 x 29	2" - 4 - V	VSS3629	\$1,067	\$1,168	\$1,199
	42 x 42 x 29	2" - 4 - V	VSS4229	\$1,199	\$1,315	\$1,351
	48 x 48 x 29	2" - 4 - V	VSS4829	\$1,301	\$1,433	\$1,544
	54 x 54 x 29	2 3/4" - 4 - V	VSS5429	\$1,602	\$1,752	\$1,878
	60 x 60 x 29	2 3/4" - 4 - V	VSS6029	\$1,645	\$1,813	\$1,955
STANDING HEIGHT 42"						
	42 x 42 x 42	2" - 4 - V	VSS4242	\$1,448	\$1,564	\$1,599
	48 x 48 x 42	2" - 4 - V	VSS4842	\$1,539	\$1,671	\$1,711
	54 x 54 x 42	2 3/4" - 4 - V	VSS5442	\$1,794	\$1,944	\$2,070
	60 x 60 x 42	2 3/4" - 4 - V	VSS6042	\$1,896	\$2,064	\$2,207

VIEWPOINT SERIES | SOFT TRIANGLE | HEIGHTS: 18", 29", 42"



HPL TOPS | 44 standard HPL finishes

EDGES | matching & coordinating finishes in the following options:

ABS 1: PVC-free impact resistant flat edge (S)

ABS 2: Multi-Ply "Plywood Look" flat vinyl edge (M)

ABS 3: Knife (KV), 1/2" Flat edge- bevel painted in a companion color

- Refer to edge code, above in (), when pricing below -

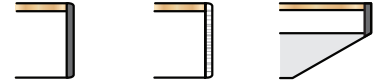

SIZE	BASE INFO #, Style	MODEL #	ABS 1 S	ABS 2 M	ABS 3 KV	
COCKTAIL HEIGHT 18"						
	30 x 30 x 18	2" - 3 - V	VST3018	\$849	\$924	\$948
	36 x 36 x 18	2" - 3 - V	VST3618	\$867	\$958	\$986
	42 x 42 x 18	2" - 3 - V	VST4218	\$998	\$1,104	\$1,137
	48 x 48 x 18	2" - 3 - V	VST4818	\$1,093	\$1,214	\$1,252
SEATED HEIGHT 29"						
	36 x 36 x 29	2" - 3 - V	VST3629	\$943	\$1,034	\$1,062
	42 x 42 x 29	2" - 3 - V	VST4229	\$1,003	\$1,109	\$1,142
	48 x 48 x 29	2" - 3 - V	VST4829	\$1,109	\$1,230	\$1,333
	54 x 54 x 29	2 3/4" - 3 - V	VST5429	\$1,338	\$1,474	\$1,589
	60 x 60 x 29	2 3/4" - 3 - V	VST6029	\$1,538	\$1,689	\$1,817
STANDING HEIGHT 42"						
	42 x 42 x 42	2" - 3 - V	VST4242	\$1,263	\$1,369	\$1,401
	48 x 48 x 42	2" - 3 - V	VST4842	\$1,366	\$1,487	\$1,525
	54 x 54 x 42	2 3/4" - 3 - V	VST5442	\$1,597	\$1,733	\$1,848
	60 x 60 x 42	2 3/4" - 3 - V	VST6042	\$1,794	\$1,945	\$2,073

VIEWPOINT SERIES | BOWED TRIANGLE | HEIGHTS: 18", 29", 42"



HPL TOPS | 44 standard HPL finishes

EDGES | matching & coordinating finishes in the following options:

ABS 1: PVC-free impact resistant flat edge (S)

ABS 2: Multi-Ply "Plywood Look" flat vinyl edge (M)

ABS 3: Knife (KV), 1/2" Flat edge- bevel painted in a companion color

- Refer to edge code, above in (), when pricing below -

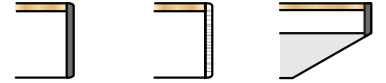

SIZE	BASE INFO #, Style	MODEL #	ABS 1 S	ABS 2 M	ABS 3 KV	
COCKTAIL HEIGHT 18"						
	30 x 30 x 18	2" - 3 - V	VBT3018	\$790	\$866	\$889
	36 x 36 x 18	2" - 3 - V	VBT3618	\$886	\$976	\$1,004
	42 x 42 x 18	2" - 3 - V	VBT4218	\$1,024	\$1,129	\$1,161
	48 x 48 x 18	2" - 3 - V	VBT4818	\$1,127	\$1,247	\$1,284
SEATED HEIGHT 29"						
	36 x 36 x 29	2" - 3 - V	VBT3629	\$958	\$1,048	\$1,076
	42 x 42 x 29	2" - 3 - V	VBT4229	\$1,006	\$1,111	\$1,144
	48 x 48 x 29	2" - 3 - V	VBT4829	\$1,120	\$1,240	\$1,343
	54 x 54 x 29	2 3/4" - 3 - V	VBT5429	\$1,515	\$1,651	\$1,766
	60 x 60 x 29	2 3/4" - 3 - V	VBT6029	\$1,558	\$1,708	\$1,835
STANDING HEIGHT 42"						
	42 x 42 x 42	2" - 3 - V	VBT4242	\$1,162	\$1,267	\$1,300
	48 x 48 x 42	2" - 3 - V	VBT4842	\$1,276	\$1,397	\$1,499
	54 x 54 x 42	2 3/4" - 3 - V	VBT5442	\$1,682	\$1,818	\$1,932
	60 x 60 x 42	2 3/4" - 3 - V	VBT6042	\$1,725	\$1,875	\$2,002

VIEWPOINT SERIES | ELONGATED BOWED TRIANGLE | HEIGHTS: 18", 29", 42"



HPL TOPS | 44 standard HPL finishes

EDGES | matching & coordinating finishes in the following options:

ABS 1: PVC-free impact resistant flat edge (S)

ABS 2: Multi-Ply "Plywood Look" flat vinyl edge (M)

ABS 3: Knife (KV), 1/2" Flat edge- bevel painted in a companion color

- Refer to edge code, above in (), when pricing below -

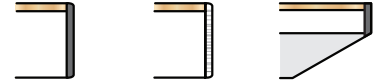

SIZE	BASE INFO #, Style	MODEL #	ABS 1 S	ABS 2 M	ABS 3 KV	
COCKTAIL HEIGHT 18"						
	30 x 48 x 18	2" - 3 - V	VEBT304818	\$914	\$1,012	\$1,043
	36 x 48 x 18	2" - 3 - V	VEBT364818	\$993	\$1,098	\$1,130
	36 x 60 x 18	2" - 3 - V	VEBT366018	\$1,079	\$1,202	\$1,239
SEATED HEIGHT 29"						
	36 x 72 x 29	2 3/4" - 3 - V	VEBT367229	\$1,302	\$1,441	\$1,484
	42 x 84 x 29	2 3/4" - 3 - V	VEBT428429	\$1,492	\$1,654	\$1,704
	48 x 96 x 29	2 3/4" - 3 - V	VEBT489629	\$1,749	\$1,934	\$1,991
STANDING HEIGHT 42"						
	42 x 84 x 42	2 3/4" - 3 - V	VEBT428442	\$1,659	\$1,821	\$1,870
	48 x 84 x 42	2 3/4" - 3 - V	VEBT488442	\$1,855	\$2,022	\$2,074
	48 x 96 x 42	2 3/4" - 3 - V	VEBT489642	\$1,918	\$2,104	\$2,161



HPL TOPS | 44 standard HPL finishes

EDGES | matching & coordinating finishes in the following options:



ABS 1: PVC-free impact resistant flat edge (S)

ABS 2: Multi-Ply "Plywood Look" flat vinyl edge (M)

ABS 3: Knife (KV), 1/2" Flat edge- bevel painted in a companion color

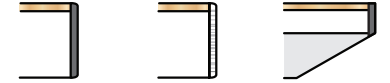
- Refer to edge code, above in (), when pricing below -



SIZE	BASE INFO #, Style	MODEL #	ABS 1 S	ABS 2 M	ABS 3 KV	
COCKTAIL HEIGHT 18"						
	26 x 30 x 18	2" - 3 - V	VGP263018	\$777	\$845	\$947
	32 x 36 x 18	2" - 3 - V	VGP323618	\$858	\$941	\$1,017
	36 x 42 x 18	2" - 3 - V	VGP364218	\$908	\$1,003	\$1,199
	42 x 48 x 18	2" - 3 - V	VGP424818	\$1,075	\$1,185	\$1,218
SEATED HEIGHT 29"						
	32 x 36 x 29	2" - 3 - V	VGP323629	\$877	\$960	\$986
	36 x 42 x 29	2" - 3 - V	VGP364229	\$928	\$1,023	\$1,052
	42 x 48 x 29	2" - 3 - V	VGP424829	\$1,083	\$1,193	\$1,285
	48 x 54 x 29	2 3/4" - 3 - V	VGP485429	\$1,289	\$1,414	\$1,519
	54 x 60 x 29	2 3/4" - 3 - V	VGP546029	\$1,519	\$1,658	\$1,775
STANDING HEIGHT 42"						
	36 x 42 x 42	2" - 3 - V	VGP364242	\$1,118	\$1,213	\$1,242
	42 x 48 x 42	2" - 3 - V	VGP424842	\$1,361	\$1,471	\$1,564
	48 x 54 x 42	2 3/4" - 3 - V	VGP485442	\$1,456	\$1,580	\$1,686
	54 x 60 x 42	2 3/4" - 3 - V	VGP546042	\$1,686	\$1,825	\$1,942



PL TOPS | 44 standard HPL finishes

DGES | matching & coordinating finishes in the following options:



ABS 1: PVC-free impact resistant flat edge (S)

ABS 2: Multi-Ply "Plywood Look" flat vinyl edge (M)

ABS 3: Knife (KV), 1/2" Flat edge- bevel painted in a companion color

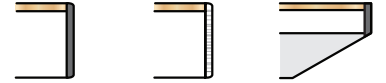
- Refer to edge code, above in (), when pricing below -



SIZE	BASE INFO #, Style	MODEL #	ABS 1 S	ABS 2 M	ABS 3 KV	
COCKTAIL HEIGHT 18"						
	24 x 48 x 18	2" - 3 - V	VEGP244818	\$847	\$938	\$1,115
	30 x 60 x 18	2" - 3 - V	VEGP306018	\$995	\$1,109	\$1,144
SEATED HEIGHT 29"						
	36 x 72 x 29	2 3/4" - 3 - V	VEGP367229	\$1,302	\$1,438	\$1,480
	42 x 84 x 29	2 3/4" - 3 - V	VEGP428429	\$1,492	\$1,651	\$1,699
	48 x 96 x 29	2 3/4" - 3 - V	VEGP489629	\$1,749	\$1,930	\$1,986
STANDING HEIGHT 42"						
	42 x 84 x 42	2 3/4" - 3 - V	VEGP428442	\$1,659	\$1,817	\$1,866
	48 x 96 x 42	2 3/4" - 3 - V	VEGP489642	\$1,918	\$2,100	\$2,156



HPL TOPS | 44 standard HPL finishes

EDGES | matching & coordinating finishes in the following options:

ABS 1: PVC-free impact resistant flat edge (S)

ABS 2: Multi-Ply "Plywood Look" flat vinyl edge (M)

ABS 3: Knife (KV), 1/2" Flat edge- bevel painted in a companion color

- Refer to edge code, above in (), when pricing below -

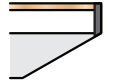

SIZE	BASE INFO #, Style	MODEL #	ABS 1 S	ABS 2 M	ABS 3 KV	
SEATED HEIGHT 29"						
	42 x 84 x 29	2 3/4" - 4 - V	VSP428429	\$1,845	\$2,016	\$2,069
	48 x 84 x 29	2 3/4" - 4 - V	VSP488429	\$1,969	\$2,147	\$2,201
	48 x 96 x 29	2 3/4" - 4 - V	VSP489629	\$2,023	\$2,218	\$2,278
	60 x 96 x 29	2 3/4" - 4 - V	VSP609629	\$2,297	\$2,500	\$2,563
STANDING HEIGHT 42"						
	48 x 84 x 42	2 3/4" - 4 - V	VSP488442	\$2,228	\$2,405	\$2,460
	48 x 96 x 42	2 3/4" - 4 - V	VSP489642	\$2,282	\$2,478	\$2,538



HPL TOPS | 44 standard HPL finishes

EDGES | matching & coordinating finishes in the following options:







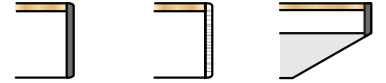

ABS 1: PVC-free impact resistant flat edge (S)

ABS 2: Multi-Ply "Plywood Look" flat vinyl edge (M)

ABS 3: Knife (KV), 1/2" Flat edge- bevel painted in a companion color

- Refer to edge code, above in (), when pricing below -



SIZE	BASE INFO #, Style	MODEL #	ABS 1 S	ABS 2 M	ABS 3 KV	
COCKTAIL HEIGHT 18"						
	30 x 48 x 18	2" - 4 - V	VSW304818	\$1,071	\$1,181	\$1,215
	36 x 60 x 18	2" - 4 - V	VSW366018	\$1,226	\$1,363	\$1,405
SEATED HEIGHT 29"						
	42 x 84 x 29	2 3/4" - 4 - V	VSW428429	\$1,801	\$1,984	\$2,040
	42 x 90 x 29	2 3/4" - 4 - V	VSW429029	\$1,855	\$2,047	\$2,105
	48 x 84 x 29	2 3/4" - 4 - V	VSW488429	\$1,948	\$2,139	\$2,198
	48 x 96 x 29	2 3/4" - 4 - V	VSW489629	\$2,008	\$2,218	\$2,282
STANDING HEIGHT 42"						
	48 x 84 x 42	2 3/4" - 4 - V	VSW488442	\$2,207	\$2,399	\$2,458
	48 x 96 x 42	2 3/4" - 4 - V	VSW489642	\$2,268	\$2,477	\$2,542



HPL TOPS | 44 standard HPL finishes

METAL BASES | 11 powder coat finishes

EDGES | matching & coordinating finishes in the following options:

ABS 1: PVC-free impact resistant flat edge (S)

ABS 2: Multi-Ply "Plywood Look" flat vinyl edge (M)

ABS 3: Knife (KV), 1/2" Flat edge- bevel painted in a companion color

- Refer to edge code, above in (), when pricing below -

NOTE: 120" & 144" lengths require 2 piece tops with 6 legs (as shown above). Alignment of woodgrain patterns between two halves cannot be guaranteed, draw-tight hardware & wafers are included for installation.

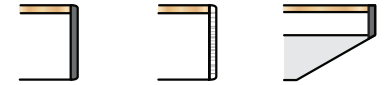

SIZE	BASE INFO #, Style	MODEL #	ABS 1 S	ABS 2 M	ABS 3 KV	
COCKTAIL HEIGHT 18"						
	24 x 36 x 18	2" - 4 - V	VWV243618	\$979	\$1,072	\$1,101
	24 x 42 x 18	2" - 4 - V	VWV244218	\$1,009	\$1,112	\$1,144
	24 x 48 x 18	2" - 4 - V	VWV244818	\$1,040	\$1,152	\$1,186
	24 x 60 x 18	2" - 4 - V	VWV246018	\$1,102	\$1,233	\$1,273
	30 x 42 x 18	2" - 4 - V	VWV304218	\$1,062	\$1,174	\$1,208
	30 x 48 x 18	2" - 4 - V	VWV304818	\$1,102	\$1,224	\$1,261
	30 x 60 x 18	2" - 4 - V	VWV306018	\$1,179	\$1,319	\$1,362
SEATED HEIGHT 29"						
	36 x 54 x 29	2" - 4 - V	VWV365429	\$1,205	\$1,345	\$1,388
	36 x 60 x 29	2" - 4 - V	VWV366029	\$1,254	\$1,404	\$1,450
	36 x 72 x 29	2" - 4 - V	VWV367229	\$1,349	\$1,517	\$1,569
	36 x 84 x 29	2" - 4 - V	VWV368429	\$1,518	\$1,704	\$1,762
	36 x 96 x 29	2" - 4 - V	VWV369629	\$1,615	\$1,823	\$1,888
	42 x 60 x 29	2 3/4" - 4 - V	VWV426029	\$1,473	\$1,641	\$1,693
	42 x 72 x 29	2 3/4" - 4 - V	VWV427229	\$1,527	\$1,713	\$1,771
42 x 84 x 29	2 3/4" - 4 - V	VWV428429	\$1,766	\$1,974	\$2,038	
42 x 96 x 29	2 3/4" - 4 - V	VWV429629	\$1,878	\$2,102	\$2,171	
	42 x 120 x 29	2 3/4" - 6 - V	VWV2T4212029	\$2,544	\$2,805	\$3,027
	42 x 144 x 29	2 3/4" - 6 - V	VWV2T4214429	\$2,736	\$3,016	\$3,254
	48 x 60 x 29	2 3/4" - 4 - V	VWV486029	\$1,522	\$1,691	\$1,742
	48 x 72 x 29	2 3/4" - 4 - V	VWV487229	\$1,624	\$1,811	\$1,868
	48 x 84 x 29	2 3/4" - 4 - V	VWV488429	\$1,890	\$2,099	\$2,163
	48 x 96 x 29	2 3/4" - 4 - V	VWV489629	\$1,951	\$2,175	\$2,244
	48 x 120 x 29	2 3/4" - 6 - V	VWV2T4812029	\$2,752	\$3,014	\$3,235
	48 x 144 x 29	2 3/4" - 6 - V	VWV2T4814429	\$2,855	\$3,154	\$3,407
	42 x 60 x 29	2 3/4" - 4 - A	VWA426029	\$1,473	\$1,641	\$1,693
	42 x 72 x 29	2 3/4" - 4 - A	VWA427229	\$1,527	\$1,713	\$1,771
	42 x 84 x 29	2 3/4" - 4 - A	VWA428429	\$1,766	\$1,974	\$2,038
	42 x 96 x 29	2 3/4" - 4 - A	VWA429629	\$1,878	\$2,102	\$2,171
	42 x 120 x 29	2 3/4" - 6 - A	VWA2T4212029	\$2,544	\$2,805	\$3,027
	42 x 144 x 29	2 3/4" - 6 - A	VWA2T4214429	\$2,736	\$3,016	\$3,254
	48 x 60 x 29	2 3/4" - 4 - A	VWA486029	\$1,522	\$1,691	\$1,742
	48 x 72 x 29	2 3/4" - 4 - A	VWA487229	\$1,624	\$1,811	\$1,868
	48 x 84 x 29	2 3/4" - 4 - A	VWA488429	\$1,890	\$2,099	\$2,163
	48 x 96 x 29	2 3/4" - 4 - A	VWA489629	\$1,951	\$2,175	\$2,244
	48 x 120 x 29	2 3/4" - 6 - A	VWA2T4812029	\$2,752	\$3,014	\$3,235
	48 x 144 x 29	2 3/4" - 6 - A	VWA2T4814429	\$2,855	\$3,154	\$3,407
STANDING HEIGHT 42"						
	48 x 72 x 42	2 3/4" - 4 - V	VWV487242	\$1,881	\$2,068	\$2,125
	48 x 84 x 42	2 3/4" - 4 - V	VWV488442	\$2,150	\$2,359	\$2,423
	48 x 96 x 42	2 3/4" - 4 - V	VWV489642	\$2,211	\$2,435	\$2,504

OPTION: 3" Radius Rounded Corners RC \$70 (add to table price)

VIEWPOINT SERIES | OVAL | HEIGHTS: 18", 29", 42"



HPL TOPS | 44 standard HPL finishes

METAL BASES | 11 powder coat finishes

EDGES | matching & coordinating finishes in the following options:

ABS 1: PVC-free impact resistant flat edge (S)

ABS 2: Multi-Ply "Plywood Look" flat vinyl edge (M)

ABS 3: Knife (KV), 1/2" Flat edge- bevel painted in a companion color

- Refer to edge code, above in (), when pricing below -

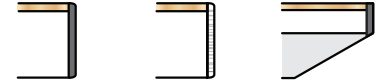

NOTE: 120" & 144" lengths require 2 piece tops with 6 legs (as shown above). Alignment of woodgrain patterns between two halves cannot be guaranteed, draw-tight hardware & wafers are included for installation.

	SIZE	BASE INFO #, Style	MODEL #	ABS 1 S	ABS 2 M	ABS 3 KV
COCKTAIL HEIGHT 18"						
	24 x 30 x 18	2" - 4 - V	VO243018	\$776	\$843	\$1,087
	26 x 36 x 18	2" - 4 - V	VO263618	\$1,000	\$1,077	\$1,144
	28 x 42 x 18	2" - 4 - V	VO284218	\$1,043	\$1,130	\$1,206
	30 x 48 x 18	2" - 4 - V	VO304818	\$1,092	\$1,190	\$1,220
SEATED HEIGHT 29"						
	32 x 54 x 29	2" - 4 - V	VO325429	\$1,191	\$1,299	\$1,332
	36 x 60 x 29	2" - 4 - V	VO366029	\$1,254	\$1,374	\$1,411
	42 x 72 x 29	2 3/4" - 4 - V	VO427229	\$1,501	\$1,644	\$1,688
	42 x 84 x 29	2 3/4" - 4 - V	VO428429	\$1,659	\$1,818	\$1,867
	42 x 90 x 29	2 3/4" - 4 - V	VO429029	\$1,802	\$1,969	\$2,021
	42 x 96 x 29	2 3/4" - 4 - V	VO429629	\$1,818	\$1,994	\$2,048
	42 x 120 x 29	2 3/4" - 6 - V	VO2T4212029	\$2,623	\$2,833	\$3,011
	42 x 144 x 29	2 3/4" - 6 - V	VO2T4214429	\$2,746	\$2,991	\$3,199
	48 x 72 x 29	2 3/4" - 4 - V	VO487229	\$1,592	\$1,741	\$1,786
	48 x 84 x 29	2 3/4" - 4 - V	VO488429	\$1,689	\$1,854	\$1,905
	48 x 90 x 29	2 3/4" - 4 - V	VO489029	\$1,824	\$1,997	\$2,050
	48 x 96 x 29	2 3/4" - 4 - V	VO489629	\$1,913	\$2,095	\$2,150
	48 x 120 x 29	2 3/4" - 6 - V	VO2T4812029	\$2,752	\$2,968	\$3,150
	48 x 144 x 29	2 3/4" - 6 - V	VO2T4814429	\$3,016	\$3,266	\$3,478
STANDING HEIGHT 42"						
	48 x 72 x 42	2 3/4" - 4 - V	VO487242	\$1,846	\$1,995	\$2,041
	48 x 84 x 42	2 3/4" - 4 - V	VO488442	\$2,113	\$2,278	\$2,328
	48 x 96 x 42	2 3/4" - 4 - V	VO489642	\$2,173	\$2,355	\$2,410

VIEWPOINT SERIES | SQUOVAL | HEIGHTS: 18", 29", 42"



HPL TOPS | 44 standard HPL finishes

METAL BASES | 11 powder coat finishes

EDGES | matching & coordinating finishes in the following options:

ABS 1: PVC-free impact resistant flat edge (S)



ABS 2: Multi-Ply "Plywood Look" flat vinyl edge (M)

ABS 3: Knife (KV), 1/2" Flat edge- bevel painted in a companion color

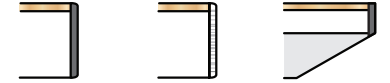
- Refer to edge code, above in (), when pricing below -

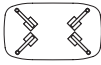
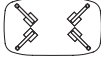
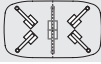
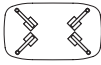
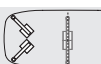
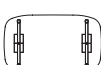
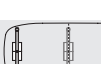
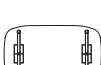

NOTE: 120" & 144" lengths require 2 piece tops with 6 legs (as shown above). Alignment of woodgrain patterns between two halves cannot be guaranteed, draw-tight hardware & wafers are included for installation.

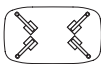
	SIZE	BASE INFO #, Style	MODEL #	ABS 1 S	ABS 2 M	ABS 3 KV
COCKTAIL HEIGHT 18"						
	21 x 36 x 18	2" - 4 - V	VSQV213618	\$941	\$1,017	\$1,041
	21 x 42 x 18	2" - 4 - V	VSQV214218	\$970	\$1,056	\$1,082
	24 x 48 x 18	2" - 4 - V	VSQV244818	\$1,009	\$1,107	\$1,137
SEATED HEIGHT 29"						
	36 x 54 x 29	2" - 4 - V	VSQV365429	\$1,280	\$1,403	\$1,442
	36 x 60 x 29	2" - 4 - V	VSQV366029	\$1,283	\$1,416	\$1,457
	36 x 72 x 29	2" - 4 - V	VSQV367229	\$1,349	\$1,501	\$1,547
	36 x 84 x 29	2" - 4 - V	VSQV368429	\$1,589	\$1,760	\$1,812
	36 x 96 x 29	2" - 4 - V	VSQV369629	\$1,730	\$1,919	\$1,977
	42 x 60 x 29	2 3/4" - 4 - V	VSQV426029	\$1,530	\$1,671	\$1,714
	42 x 72 x 29	2 3/4" - 4 - V	VSQV427229	\$1,559	\$1,718	\$1,767
	42 x 84 x 29	2 3/4" - 4 - V	VSQV428429	\$1,694	\$1,872	\$1,926
	42 x 96 x 29	2 3/4" - 4 - V	VSQV429629	\$1,792	\$1,988	\$2,048
	42 x 120 x 29	2 3/4" - 6 - V	VSQV2T4212029	\$2,544	\$2,777	\$2,975
	42 x 144 x 29	2 3/4" - 6 - V	VSQV2T4214429	\$2,736	\$3,007	\$3,236
	48 x 60 x 29	2 3/4" - 4 - V	VSQV486029	\$1,637	\$1,787	\$1,833
	48 x 72 x 29	2 3/4" - 4 - V	VSQV487229	\$1,681	\$1,849	\$1,901
	48 x 84 x 29	2 3/4" - 4 - V	VSQV488429	\$1,922	\$2,109	\$2,166
	48 x 96 x 29	2 3/4" - 4 - V	VSQV489629	\$1,955	\$2,161	\$2,224
	48 x 120 x 29	2 3/4" - 6 - V	VSQV2T4812029	\$2,896	\$3,139	\$3,344
	48 x 144 x 29	2 3/4" - 6 - V	VSQV2T4814429	\$2,999	\$3,279	\$3,516
	42 x 60 x 29	2 3/4" - 4 - A	VSQA426029	\$1,530	\$1,671	\$1,714
	42 x 72 x 29	2 3/4" - 4 - A	VSQA427229	\$1,560	\$1,718	\$1,767
	42 x 84 x 29	2 3/4" - 4 - A	VSQA428429	\$1,694	\$1,871	\$1,926
	42 x 96 x 29	2 3/4" - 4 - A	VSQA429629	\$1,792	\$1,988	\$2,048
	42 x 120 x 29	2 3/4" - 6 - A	VSQA2T4212029	\$2,544	\$2,777	\$2,975
	42 x 144 x 29	2 3/4" - 6 - A	VSQA2T4214429	\$2,736	\$3,007	\$3,236
	48 x 60 x 29	2 3/4" - 4 - A	VSQA486029	\$1,522	\$1,672	\$1,718
	48 x 72 x 29	2 3/4" - 4 - A	VSQA487229	\$1,681	\$1,849	\$1,901
	48 x 84 x 29	2 3/4" - 4 - A	VSQA488429	\$1,922	\$2,109	\$2,166
	48 x 96 x 29	2 3/4" - 4 - A	VSQA489629	\$1,955	\$2,161	\$2,224
	48 x 120 x 29	2 3/4" - 6 - A	VSQA2T4812029	\$2,896	\$3,139	\$3,344
	48 x 144 x 29	2 3/4" - 6 - A	VSQA2T4814429	\$2,999	\$3,279	\$3,516
STANDING HEIGHT 42"						
	48 x 72 x 42	2 3/4" - 4 - V	VSQV487242	\$1,938	\$2,106	\$2,158
	48 x 84 x 42	2 3/4" - 4 - V	VSQV488442	\$2,182	\$2,368	\$2,426
	48 x 96 x 42	2 3/4" - 4 - V	VSQV489642	\$2,216	\$2,422	\$2,485



HPL TOPS | 44 standard HPL finishes

METAL BASES | 11 powder coat finishes

EDGES | matching & coordinating finishes in the following options:

ABS 1: PVC-free impact resistant flat edge (S)







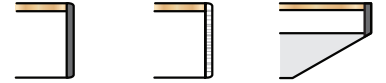

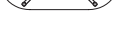

ABS 2: Multi-Ply "Plywood Look" flat vinyl edge (M)

ABS 3: Knife (KV), 1/2" Flat edge- bevel painted in a companion color

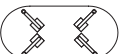
- Refer to edge code, above in (), when pricing below -



NOTE: 120" & 144" lengths require 2 piece tops with 6 legs (as shown above). Alignment of woodgrain patterns between two halves cannot be guaranteed, draw-tight hardware & wafers are included for installation.

	SIZE	BASE INFO #, Style	MODEL #	ABS 1 S	ABS 2 M	ABS 3 KV
COCKTAIL HEIGHT 18"						
	21 x 36 x 18	2" - 4 - V	VRTV213618	\$941	\$1,016	\$1,068
	21 x 42 x 18	2" - 4 - V	VRTV214218	\$970	\$1,055	\$1,119
	24 x 48 x 18	2" - 4 - V	VRTV244818	\$1,009	\$1,105	\$1,198
	30 x 48 x 18	2" - 4 - V	VRTV304818	\$1,071	\$1,173	\$1,281
	30 x 60 x 18	2" - 4 - V	VRTV306018	\$1,148	\$1,268	\$1,306
SEATED HEIGHT 29"						
	36 x 54 x 29	2" - 4 - V	VRTV365429	\$1,280	\$1,396	\$1,432
	36 x 60 x 29	2" - 4 - V	VRTV366029	\$1,283	\$1,409	\$1,448
	36 x 72 x 29	2" - 4 - V	VRTV367229	\$1,349	\$1,494	\$1,538
	36 x 84 x 29	2" - 4 - V	VRTV368429	\$1,589	\$1,753	\$1,803
	36 x 96 x 29	2" - 4 - V	VRTV369629	\$1,730	\$1,912	\$1,968
	42 x 60 x 29	2 3/4" - 4 - V	VRTV426029	\$1,530	\$1,661	\$1,701
	42 x 72 x 29	2 3/4" - 4 - V	VRTV427229	\$1,632	\$1,781	\$1,827
	42 x 84 x 29	2 3/4" - 4 - V	VRTV428429	\$1,694	\$1,862	\$1,914
	42 x 96 x 29	2 3/4" - 4 - V	VRTV429629	\$1,792	\$1,979	\$2,036
	42 x 120 x 29	2 3/4" - 6 - V	VRTV2T4212029	\$2,505	\$2,729	\$2,919
	42 x 144 x 29	2 3/4" - 6 - V	VRTV2T4214429	\$2,689	\$2,950	\$3,172
	48 x 60 x 29	2 3/4" - 4 - V	VRTV486029	\$1,637	\$1,775	\$1,817
	48 x 72 x 29	2 3/4" - 4 - V	VRTV487229	\$1,681	\$1,837	\$1,885
	48 x 84 x 29	2 3/4" - 4 - V	VRTV488429	\$1,923	\$2,098	\$2,151
	48 x 96 x 29	2 3/4" - 4 - V	VRTV489629	\$1,956	\$2,149	\$2,209
	48 x 120 x 29	2 3/4" - 6 - V	VRTV2T4812029	\$2,579	\$2,810	\$3,005
	48 x 144 x 29	2 3/4" - 6 - V	VRTV2T4814429	\$2,700	\$2,968	\$3,194
	42 x 60 x 29	2 3/4" - 4 - A	VRTA426029	\$1,530	\$1,661	\$1,701
	42 x 72 x 29	2 3/4" - 4 - A	VRTA427229	\$1,632	\$1,781	\$1,827
	42 x 84 x 29	2 3/4" - 4 - A	VRTA428429	\$1,786	\$1,954	\$2,006
	42 x 96 x 29	2 3/4" - 4 - A	VRTA429629	\$1,818	\$2,005	\$2,062
	42 x 120 x 29	2 3/4" - 6 - A	VRTA2T4212029	\$2,505	\$2,729	\$2,919
	42 x 144 x 29	2 3/4" - 6 - A	VRTA2T4214429	\$2,689	\$2,950	\$3,172
	48 x 60 x 29	2 3/4" - 4 - A	VRTA486029	\$1,637	\$1,775	\$1,817
	48 x 72 x 29	2 3/4" - 4 - A	VRTA487229	\$1,681	\$1,837	\$1,885
	48 x 84 x 29	2 3/4" - 4 - A	VRTA488429	\$1,923	\$2,098	\$2,151
	48 x 96 x 29	2 3/4" - 4 - A	VRTA489629	\$1,956	\$2,149	\$2,209
	48 x 120 x 29	2 3/4" - 6 - A	VRTA2T4812029	\$2,551	\$2,781	\$2,976
	48 x 144 x 29	2 3/4" - 6 - A	VRTA2T4814429	\$2,700	\$2,968	\$3,194
STANDING HEIGHT 42"						
	48 x 72 x 42	2 3/4" - 4 - V	VRTV487242	\$1,846	\$2,001	\$2,049
	48 x 84 x 42	2 3/4" - 4 - V	VRTV488442	\$2,040	\$2,213	\$2,267
	48 x 96 x 42	2 3/4" - 4 - V	VRTV489642	\$2,100	\$2,293	\$2,352

VIEWPOINT SERIES | D-SHAPE | HEIGHTS: 29", 42"



HPL TOPS | 44 standard HPL finishes

METAL BASES | 11 powder coat finishes

EDGES | matching & coordinating finishes in the following options:

ABS 1: PVC-free impact resistant flat edge (S)

ABS 2: Multi-Ply "Plywood Look" flat vinyl edge (M)

ABS 3: Knife (KV), 1/2" Flat edge- bevel painted in a companion color

- Refer to edge code, above in (), when pricing below -

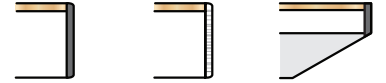

NOTE: 120" & 144" lengths require 2 piece tops with 6 legs (as shown above). Alignment of woodgrain patterns between two halves cannot be guaranteed, draw-tight hardware & wafers are included for installation.

	SIZE	BASE INFO #, Style	MODEL #	ABS 1 S	ABS 2 M	ABS 3 KV
SEATED HEIGHT 29"						
	36 x 54 x 29	2" - 4 - V	VDV365429	\$1,205	\$1,305	\$1,336
	36 x 60 x 29	2" - 4 - V	VDV366029	\$1,254	\$1,364	\$1,398
	36 x 72 x 29	2" - 4 - V	VDV367229	\$1,349	\$1,477	\$1,517
	36 x 84 x 29	2" - 4 - V	VDV368429	\$1,518	\$1,665	\$1,710
	36 x 96 x 29	2" - 4 - V	VDV369629	\$1,615	\$1,781	\$1,832
	42 x 60 x 29	2 3/4" - 4 - V	VDV426029	\$1,473	\$1,618	\$1,662
	42 x 72 x 29	2 3/4" - 4 - V	VDV427229	\$1,527	\$1,690	\$1,740
	42 x 84 x 29	2 3/4" - 4 - V	VDV428429	\$1,766	\$1,948	\$2,004
	42 x 96 x 29	2 3/4" - 4 - V	VDV429629	\$1,878	\$2,079	\$2,141
	42 x 120 x 29	2 3/4" - 6 - V	VDV2T4212029	\$2,544	\$2,782	\$2,984
	42 x 144 x 29	2 3/4" - 6 - V	VDV2T4214429	\$2,736	\$3,012	\$3,245
	48 x 60 x 29	2 3/4" - 4 - V	VDV486029	\$1,498	\$1,651	\$1,698
	48 x 72 x 29	2 3/4" - 4 - V	VDV487229	\$1,596	\$1,767	\$1,820
	48 x 84 x 29	2 3/4" - 4 - V	VDV488429	\$1,936	\$2,126	\$2,184
	48 x 96 x 29	2 3/4" - 4 - V	VDV489629	\$1,971	\$2,179	\$2,244
	48 x 120 x 29	2 3/4" - 6 - V	VDV2T4812029	\$2,752	\$2,998	\$3,206
	48 x 144 x 29	2 3/4" - 6 - V	VDV2T4814429	\$2,855	\$3,139	\$3,378
	54 x 54 x 29	2 3/4" - 4 - V	VDV545429	\$1,602	\$1,753	\$1,880
	60 x 60 x 29	2 3/4" - 4 - V	VDV606029	\$1,645	\$1,812	\$1,954
	42 x 60 x 29	2 3/4" - 4 - A	VDA426029	\$1,473	\$1,618	\$1,662
	42 x 72 x 29	2 3/4" - 4 - A	VDA427229	\$1,527	\$1,690	\$1,740
	42 x 84 x 29	2 3/4" - 4 - A	VDA428429	\$1,766	\$1,948	\$2,004
	42 x 96 x 29	2 3/4" - 4 - A	VDA429629	\$1,878	\$2,079	\$2,141
	42 x 120 x 29	2 3/4" - 6 - A	VDA2T4212029	\$2,544	\$2,782	\$2,984
	42 x 144 x 29	2 3/4" - 6 - A	VDA2T4214429	\$2,736	\$3,012	\$3,245
	48 x 60 x 29	2 3/4" - 4 - A	VDA486029	\$1,498	\$1,651	\$1,698
	48 x 72 x 29	2 3/4" - 4 - A	VDA487229	\$1,596	\$1,767	\$1,820
	48 x 84 x 29	2 3/4" - 4 - A	VDA488429	\$1,936	\$2,126	\$2,184
	48 x 96 x 29	2 3/4" - 4 - A	VDA489629	\$1,971	\$2,179	\$2,244
	48 x 120 x 29	2 3/4" - 6 - A	VDA2T4812029	\$2,752	\$2,998	\$3,206
	48 x 144 x 29	2 3/4" - 6 - A	VDA2T4814429	\$2,855	\$3,139	\$3,378
STANDING HEIGHT 42"						
	48 x 72 x 42	2 3/4" - 4 - V	VDV487242	\$1,891	\$2,063	\$2,115
	48 x 84 x 42	2 3/4" - 4 - V	VDV488442	\$2,158	\$2,348	\$2,407
	48 x 96 x 42	2 3/4" - 4 - V	VDV489642	\$2,193	\$2,402	\$2,466
	54 x 54 x 42	2 3/4" - 4 - V	VDV545442	\$1,745	\$1,895	\$2,022
	60 x 60 x 42	2 3/4" - 4 - V	VDV606042	\$1,788	\$1,955	\$2,097

VIEWPOINT SERIES | RECTANGLE | HEIGHTS: 18", 29", 42"



HPL TOPS | 44 standard HPL finishes

METAL BASES | 11 powder coat finishes

EDGES | matching & coordinating finishes in the following options:

ABS 1: PVC-free impact resistant flat edge (S)

ABS 2: Multi-Ply "Plywood Look" flat vinyl edge (M)

ABS 3: Knife (KV), 1/2" Flat edge- bevel painted in a companion color

NOTE: 120" & 144" lengths require 2 piece tops with 6 legs (as shown above). Alignment of woodgrain patterns between two halves cannot be guaranteed, draw-tight hardware & wafers are included for installation.

- Refer to edge code, above in (), when pricing below -



	SIZE	BASE INFO #, Style	MODEL #	ABS 1 S	ABS 2 M	ABS 3 KV
COCKTAIL HEIGHT 18"						
	24 x 36 x 18	2" - 4 - V	VRV243618	\$861	\$955	\$984
	24 x 42 x 18	2" - 4 - V	VRV244218	\$898	\$1,000	\$1,032
	24 x 48 x 18	2" - 4 - V	VRV244818	\$891	\$1,003	\$1,037
	24 x 60 x 18	2" - 4 - V	VRV246018	\$953	\$1,084	\$1,124
	30 x 42 x 18	2" - 4 - V	VRV304218	\$956	\$1,068	\$1,103
	30 x 48 x 18	2" - 4 - V	VRV304818	\$953	\$1,075	\$1,112
	30 x 60 x 18	2" - 4 - V	VRV306018	\$987	\$1,127	\$1,170
SEATED HEIGHT 29"						
	36 x 54 x 29	2" - 4 - V	VRV365429	\$1,098	\$1,238	\$1,281
	36 x 60 x 29	2" - 4 - V	VRV366029	\$1,100	\$1,250	\$1,296
	36 x 72 x 29	2" - 4 - V	VRV367229	\$1,149	\$1,317	\$1,369
	36 x 84 x 29	2" - 4 - V	VRV368429	\$1,345	\$1,532	\$1,589
	36 x 96 x 29	2" - 4 - V	VRV369629	\$1,428	\$1,637	\$1,701
	42 x 60 x 29	2 3/4" - 4 - V	VRV426029	\$1,201	\$1,369	\$1,421
	42 x 72 x 29	2 3/4" - 4 - V	VRV427229	\$1,280	\$1,467	\$1,524
	42 x 84 x 29	2 3/4" - 4 - V	VRV428429	\$1,503	\$1,712	\$1,776
	42 x 96 x 29	2 3/4" - 4 - V	VRV429629	\$1,542	\$1,766	\$1,835
	42 x 120 x 29	2 3/4" - 6 - V	VRV2T4212029	\$2,326	\$2,588	\$2,809
	42 x 144 x 29	2 3/4" - 6 - V	VRV2T4214429	\$2,499	\$2,779	\$3,016
	48 x 60 x 29	2 3/4" - 4 - V	VRV486029	\$1,280	\$1,448	\$1,500
	48 x 72 x 29	2 3/4" - 4 - V	VRV487229	\$1,359	\$1,546	\$1,603
	48 x 84 x 29	2 3/4" - 4 - V	VRV488429	\$1,463	\$1,672	\$1,736
	48 x 96 x 29	2 3/4" - 4 - V	VRV489629	\$1,551	\$1,775	\$1,844
	48 x 120 x 29	2 3/4" - 6 - V	VRV2T4812029	\$2,361	\$2,622	\$2,844
	48 x 144 x 29	2 3/4" - 6 - V	VRV2T4814429	\$2,496	\$2,795	\$3,048
	42 x 60 x 29	2 3/4" - 4 - A	VRA426029	\$1,201	\$1,369	\$1,421
	42 x 72 x 29	2 3/4" - 4 - A	VRA427229	\$1,280	\$1,467	\$1,524
	42 x 84 x 29	2 3/4" - 4 - A	VRA428429	\$1,503	\$1,712	\$1,776
	42 x 96 x 29	2 3/4" - 4 - A	VRA429629	\$1,542	\$1,766	\$1,835
	42 x 120 x 29	2 3/4" - 6 - A	VRA2T4212029	\$2,326	\$2,588	\$2,809
	42 x 144 x 29	2 3/4" - 6 - A	VRA2T4214429	\$2,499	\$2,779	\$3,016
	48 x 60 x 29	2 3/4" - 4 - A	VRA486029	\$1,280	\$1,448	\$1,500
	48 x 72 x 29	2 3/4" - 4 - A	VRA487229	\$1,359	\$1,546	\$1,603
	48 x 84 x 29	2 3/4" - 4 - A	VRA488429	\$1,463	\$1,672	\$1,736
	48 x 96 x 29	2 3/4" - 4 - A	VRA489629	\$1,551	\$1,775	\$1,844
	48 x 120 x 29	2 3/4" - 6 - A	VRA2T4812029	\$2,361	\$2,622	\$2,844
	48 x 144 x 29	2 3/4" - 6 - A	VRA2T4814429	\$2,496	\$2,795	\$3,048
	60 x 120 x 29	2 3/4" - 6 - A	VRA2T6012029	\$2,889	\$3,170	\$3,407
	60 x 144 x 29	2 3/4" - 6 - A	VRA2T6014429	\$3,156	\$3,474	\$3,742
STANDING HEIGHT 42"						
	48 x 72 x 42	2 3/4" - 4 - V	VRV487242	\$1,627	\$1,814	\$1,872
	48 x 84 x 42	2 3/4" - 4 - V	VRV488442	\$1,732	\$1,937	\$2,001
	48 x 96 x 42	2 3/4" - 4 - V	VRV489642	\$1,819	\$2,044	\$2,113

OPTION: 3" Radius Rounded Corners RC \$70 (add to table price)

COMMUTER SERIES | LAPTOP TABLES | 5 STYLES | 6 TOP SHAPES



COMMUTER 2



COMMUTER 1



COMMUTER 5

3/4" HPL TOPS | 44 Standard HPL Finishes, in 6 Shapes

FLAT EDGES | Matching & Coordinating Finishes in the Following:

- STANDARD: PVC-Free Impact Resistant (S) - PRICING SHOWN BELOW
- PREMIUM: Multi-Ply "Plywood Look" (M) *ADD \$55 LIST TO TABLE PRICE

METAL BASES | 9 Powdercoat finishes | Disc, Square or Rectangle Shapes

- 2 Fixed Height Styles: Straight or Bent Column (See Commuter 1, 3 & 4 Below)
- 2 Adjustable Height Styles: Round or Square Column (See Commuter 2 & 5 Below)
- 1 Tilting Top Style (See Commuter 5 Below)
- 25-30 lb. Capacity

STYLE / MODEL # BASE INFO	TABLE HEIGHT	TOP SHAPES & SIZES					
		ROUND (R) 15" DIA.	SOFT WEDGE (SW) 13.25" x 18"	SQUOVAL (SO) 14" x 19"	ROUNDED SQUARE (RS) 15.25" sq.	SOFT SQUARE (SS) 15.25" sq.	SOFT TAPERED (ST) 14.5" x 21"
C1 FIXED HEIGHT OFFSET, BENT ROUND COLUMN: 1.25" DIA.							
<input type="checkbox"/> C1F912 BASE PLATE: 9 X 12 RECTANGLE26" H		\$589	\$589	-	\$589	\$589	-
<input type="checkbox"/> C1F129 BASE PLATE: 12 X 9 RECTANGLE26" H		\$589	-	\$589	\$589	\$589	\$589
<input type="checkbox"/> C1F12D BASE PLATE: 12" DIAMETER DISC26" H		\$589	\$589	\$589	\$589	\$589	\$589
POWDERCOAT BASE OPTIONS: BLACK(BB), SILVER METALLIC(SM), SLATE(SL), SOFT WHITE(SW)							
C2 ADJUSTABLE HEIGHT OFFSET, STRAIGHT ROUND COLUMN 1.57" DIA.							
<input type="checkbox"/> C2A912BASE PLATE: 9 X 12 Rectangle21-30.75" H		\$870	\$870	-	\$870	\$870	-
<input type="checkbox"/> C2A129BASE PLATE: 12 X 9 Rectangle21-30.75" H		\$870	-	\$870	\$870	\$870	\$870
<input type="checkbox"/> C2A12DBASE PLATE: 12" Diameter Disc21-30.75" H		\$870	\$870	\$870	\$870	\$870	\$870
POWDERCOAT BASE OPTIONS: BLACK(BB), SILVER METALLIC(SM), SLATE(SL), SOFT WHITE(SW)							
C3 FIXED HEIGHT OFFSET, STRAIGHT ROUND COLUMN 1.5" DIA.							
<input type="checkbox"/> C3F1015 ...BASE PLATE: 10.5 X 15.5 Rectangle25.25" H		-	-	\$1,024	-	-	\$1,024
<input type="checkbox"/> C3F14DBASE PLATE: 14" Diameter Disc25.25" H		\$1,024	-	-	\$1,024	\$1,024	\$1,024
POWDERCOAT BASE OPTIONS: BLACK(BB), BLACK WRINKLE(BW), LIGHT GRAY(LG), MEDIUM TONE(MT), SILVER METALLIC(SM), SLATE(SL), SOFT WHITE(SW), PUTTY(PB)							
C4 FIXED HEIGHT CENTERED, STRAIGHT ROUND COLUMN 1.5" DIA.							
<input type="checkbox"/> C4F14DBASE PLATE: 14" Diameter Disc25.25" H		\$1,024	-	-	\$1,024	\$1,024	\$1,024
POWDERCOAT BASE OPTIONS: BLACK(BB), BLACK WRINKLE(BW), LIGHT GRAY(LG), MEDIUM TONE(MT), SILVER METALLIC(SM), SLATE(SL), SOFT WHITE(SW), PUTTY(PB)							
C5 ADJUSTABLE HEIGHT WITH TILT TOP CENTERED, STRAIGHT SQUARE COLUMN 1.57" SQUARE							
<input type="checkbox"/> C5A13SS...BASE PLATE: 13.75" Soft Square 25.55-40.75" H		-	-	\$1,083	\$1,083	\$1,083	\$1,083
POWDERCOAT BASE OPTIONS: BLACK(BB), WHITE(WH) ALL TILT TOPS INCLUDE A THIN ALUMINUM SUPPORT LEDGE							

COMMUTER SAMPLE SPEC - Use supplied model #'s & suffix codes above in () when specing product, see sample spec below-

MODEL #	TOP SHAPE	HPL FINISH	EDGE <small>PREMIUM EDGE ADD \$55 TO LIST</small>	POWDERCOAT	FINAL MODEL #
C1F912-	R-	7911-	SME-	SM	C1F912-R-7911-SME-SM

3400 Credenzas.....	158
3500 Credenzas.....	160
3600 Combo Credenzas	164
Lecterns.....	165
Serving Carts.....	166
Phone Stands.....	166





HPL TOPS & CABINET EXTERIOR | 44 standard HPL finishes

EDGES | matching & coordinating finishes.

TOP EDGE OPTIONS (* Applicable to front edge ONLY)

ABS 1: PVC-free impact resistant flat edge (S)

ABS 2: Multi-Ply "Plywood Look" flat vinyl edge (M)

* ABS 3: Knife (KV), 1/2" Flat edge- bevel painted in a companion color

Standard Features:

- Adjustable shelf included in each storage area.
- Default 4" Elliptical Door Pull. Other standard pull options available. See page 189.
- Consult Factory for Premium Pulls, options shown on page 189.
- 3" High kickbase. Adjustable leveling glides included.
- Locking option, and Additional options/accessories available, consult factory.

- Refer to edge code, above in (), when pricing below -

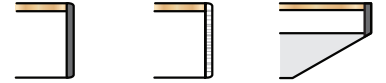

	SIZE	BASE INFO #, Style	MODEL #	ABS 1 S	ABS 2 M	ABS 3 KV
2-DOOR CRENZAS - 29" H.						
	20 x 30 x 29	3" H. Kickbase	3400203029	\$1,122	\$1,202	\$1,227
	20 x 36 x 29	3" H. Kickbase	3400203629	\$1,286	\$1,376	\$1,403
	20 x 42 x 29	3" H. Kickbase	3400204229	\$1,572	\$1,671	\$1,701
	20 x 48 x 29	3" H. Kickbase	3400204829	\$1,747	\$1,856	\$1,889
	24 x 30 x 29	3" H. Kickbase	3400243029	\$1,222	\$1,308	\$1,335
	24 x 36 x 29	3" H. Kickbase	3400243629	\$1,395	\$1,491	\$1,520
	24 x 42 x 29	3" H. Kickbase	3400244229	\$1,734	\$1,840	\$1,872
	24 x 48 x 29	3" H. Kickbase	3400244829	\$1,918	\$2,033	\$2,068
2-DOOR CRENZAS - 36" H.						
	20 x 30 x 36	3" H. Kickbase	3400203036	\$1,192	\$1,272	\$1,296
	20 x 36 x 36	3" H. Kickbase	3400203636	\$1,364	\$1,453	\$1,481
	20 x 42 x 36	3" H. Kickbase	3400204236	\$1,663	\$1,763	\$1,793
	20 x 48 x 36	3" H. Kickbase	3400204836	\$1,846	\$1,954	\$1,988
	24 x 30 x 36	3" H. Kickbase	3400243036	\$1,298	\$1,384	\$1,411
	24 x 36 x 36	3" H. Kickbase	3400243636	\$1,479	\$1,575	\$1,604
	24 x 42 x 36	3" H. Kickbase	3400244236	\$1,832	\$1,938	\$1,970
	24 x 48 x 36	3" H. Kickbase	3400244836	\$2,024	\$2,139	\$2,174
4-DOOR CRENZAS - 29" H.						
	20 x 60 x 29	3" H. Kickbase	3400206029	\$2,186	\$2,314	\$2,353
	20 x 72 x 29	3" H. Kickbase	3400207229	\$2,506	\$2,653	\$2,698
	20 x 84 x 29	3" H. Kickbase	3400208429	\$3,126	\$3,293	\$3,344
	20 x 96 x 29	3" H. Kickbase	3400209629	\$3,478	\$3,663	\$3,720
	24 x 60 x 29	3" H. Kickbase	3400246029	\$2,380	\$2,514	\$2,555
	24 x 72 x 29	3" H. Kickbase	3400247229	\$2,740	\$2,894	\$2,941
	24 x 84 x 29	3" H. Kickbase	3400248429	\$3,429	\$3,602	\$3,655
	24 x 96 x 29	3" H. Kickbase	3400249629	\$3,821	\$4,012	\$4,071
4-DOOR CRENZAS - 36" H.						
	20 x 60 x 36	3" H. Kickbase	3400206036	\$2,325	\$2,453	\$2,492
	20 x 72 x 36	3" H. Kickbase	3400207236	\$2,660	\$2,807	\$2,852
	20 x 84 x 36	3" H. Kickbase	3400208436	\$3,307	\$3,473	\$3,525
	20 x 96 x 36	3" H. Kickbase	3400209636	\$3,673	\$3,858	\$3,915
	24 x 60 x 36	3" H. Kickbase	3400246036	\$2,532	\$2,666	\$2,707
	24 x 72 x 36	3" H. Kickbase	3400247236	\$2,908	\$3,061	\$3,108
	24 x 84 x 36	3" H. Kickbase	3400248436	\$3,627	\$3,799	\$3,853
	24 x 96 x 36	3" H. Kickbase	3400249636	\$4,032	\$4,223	\$4,282



HPL TOPS & CABINET EXTERIOR | 44 standard HPL finishes
 EDGES | matching & coordinating finishes.

TOP EDGE OPTIONS (* Applicable to front edge ONLY)

ABS 1: PVC-free impact resistant flat edge (S)

ABS 2: Multi-Ply "Plywood Look" flat vinyl edge (M)

* ABS 3: Knife (KV), 1/2" Flat edge- bevel painted in a companion color

- Refer to edge code, above in (), when pricing below -

Standard Features:

- Drawers above doors. Adjustable shelf included in each storage area.
- Default 4" Elliptical Door/Drawer Pull (Shown in image above). Other standard pull options below.
- Consult Factory for Premium Pulls, options shown below.
- 3" High kickbase. Adjustable leveling glides included.
- Locking option, and additional options/accessories available, consult factory.

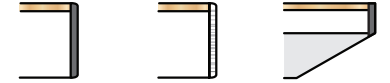

SIZE	BASE INFO #, Style	MODEL #	ABS 1 S	ABS 2 M	ABS 3 KV	
2-DOOR 1-DRAWER CRENZAS - 36" H.						
	20 x 30 x 36	3" H. Kickbase	3410203036	\$1,514	\$1,594	\$1,619
	20 x 36 x 36	3" H. Kickbase	3410203636	\$1,717	\$1,807	\$1,834
	24 x 30 x 36	3" H. Kickbase	3410243036	\$1,619	\$1,705	\$1,732
	24 x 36 x 36	3" H. Kickbase	3410243636	\$1,832	\$1,928	\$1,958
2-DOOR 2-DRAWER CRENZAS - 36" H.						
	20 x 42 x 36	3" H. Kickbase	3410204236	\$2,235	\$2,334	\$2,364
	20 x 48 x 36	3" H. Kickbase	3410204836	\$2,460	\$2,568	\$2,602
	24 x 42 x 36	3" H. Kickbase	3410244236	\$2,403	\$2,509	\$2,541
	24 x 48 x 36	3" H. Kickbase	3410244836	\$2,638	\$2,753	\$2,788
4-DOOR 2-DRAWER CRENZAS - 36" H.						
	20 x 60 x 36	3" H. Kickbase	3410206036	\$2,968	\$3,096	\$3,135
	20 x 72 x 36	3" H. Kickbase	3410207236	\$3,367	\$3,515	\$3,560
	24 x 60 x 36	3" H. Kickbase	3410246036	\$3,175	\$3,309	\$3,350
	24 x 72 x 36	3" H. Kickbase	3410247236	\$3,615	\$3,768	\$3,816
4-DOOR 4-DRAWER CRENZAS - 36" H.						
	20 x 84 x 36	3" H. Kickbase	3410208436	\$4,449	\$4,616	\$4,667
	20 x 96 x 36	3" H. Kickbase	3410209636	\$4,901	\$5,087	\$5,144
	24 x 84 x 36	3" H. Kickbase	3410248436	\$4,769	\$4,942	\$4,995
	24 x 96 x 36	3" H. Kickbase	3410249636	\$5,260	\$5,452	\$5,511

STANDARD PULL OPTIONS Included in List Price

Elliptical wire (default): approx 4 1/2" long
 Black model #: RFRH1B
 Silver model #: RFRH1S

Double Wire: approx 4 7/8" long
 Black model #: RFRH2B
 Silver model #: RFRH2S

PREMIUM PULL OPTIONS List Price: \$28 ea. (premium upcharge)

Angled Lip Pulls: 8 3/8" long
 Aluminum model #: RFALHA
 Brushed Black model #: RFALHB

Tab Lip Pulls: 8 3/8" long
 Aluminum model #: RFSTPA
 Brushed Black model #: RFSTPB
 White model #: RFSTPW

Rod Style: approx 7" long
 Brushed Nickel model #: RFRSHN
 Matte Black model #: RFRSHB



HPL TOPS & CABINET EXTERIOR | 44 standard HPL finishes

EDGES | matching & coordinating finishes.

TOP EDGE OPTIONS (* Applicable to front edge ONLY)

ABS 1: PVC-free impact resistant flat edge (S)

ABS 2: Multi-Ply "Plywood Look" flat vinyl edge (M)

* ABS 3: Knife (KV), 1/2" Flat edge- bevel painted in a companion color

Standard Features:

- Adjustable shelf included in each storage area.
- Default 4" Elliptical Door Pull. Other standard pull options available. See page 193.
- Consult Factory for Premium Pulls, options shown on page 193.
- Adjustable leveling glides included.
- Locking option, and Additional options/accessories available, consult factory.

- Refer to edge code, above in (), when pricing below -

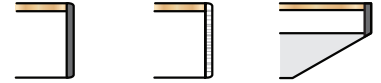

	SIZE	BASE INFO #, Style	MODEL #	ABS 1 S	ABS 2 M	ABS 3 KV
2-DOOR CRENZAS - 29" H.						
	20 x 30 x 29	Low Profile Base	3500203029	\$1,122	\$1,202	\$1,227
	20 x 36 x 29	Low Profile Base	3500203629	\$1,286	\$1,376	\$1,403
	20 x 42 x 29	Low Profile Base	3500204229	\$1,572	\$1,671	\$1,701
	20 x 48 x 29	Low Profile Base	3500204829	\$1,747	\$1,856	\$1,889
	24 x 30 x 29	Low Profile Base	3500243029	\$1,222	\$1,308	\$1,335
	24 x 36 x 29	Low Profile Base	3500243629	\$1,395	\$1,491	\$1,520
	24 x 42 x 29	Low Profile Base	3500244229	\$1,734	\$1,840	\$1,872
	24 x 48 x 29	Low Profile Base	3500244829	\$1,918	\$2,033	\$2,068
2-DOOR CRENZAS - 36" H.						
	20 x 30 x 36	Low Profile Base	3500203036	\$1,192	\$1,272	\$1,296
	20 x 36 x 36	Low Profile Base	3500203636	\$1,364	\$1,453	\$1,481
	20 x 42 x 36	Low Profile Base	3500204236	\$1,663	\$1,763	\$1,793
	20 x 48 x 36	Low Profile Base	3500204836	\$1,846	\$1,954	\$1,988
	24 x 30 x 36	Low Profile Base	3500243036	\$1,298	\$1,384	\$1,411
	24 x 36 x 36	Low Profile Base	3500243636	\$1,479	\$1,575	\$1,604
	24 x 42 x 36	Low Profile Base	3500244236	\$1,832	\$1,938	\$1,970
	24 x 48 x 36	Low Profile Base	3500244836	\$2,024	\$2,139	\$2,174
4-DOOR CRENZAS - 29" H.						
	20 x 60 x 29	Low Profile Base	3500206029	\$2,186	\$2,314	\$2,353
	20 x 72 x 29	Low Profile Base	3500207229	\$2,506	\$2,653	\$2,698
	20 x 84 x 29	Low Profile Base	3500208429	\$3,126	\$3,293	\$3,344
	20 x 96 x 29	Low Profile Base	3500209629	\$3,478	\$3,663	\$3,720
	24 x 60 x 29	Low Profile Base	3500246029	\$2,380	\$2,514	\$2,555
	24 x 72 x 29	Low Profile Base	3500247229	\$2,740	\$2,894	\$2,941
	24 x 84 x 29	Low Profile Base	3500248429	\$3,429	\$3,602	\$3,655
	24 x 96 x 29	Low Profile Base	3500249629	\$3,821	\$4,012	\$4,071
4-DOOR CRENZAS - 36" H.						
	20 x 60 x 36	Low Profile Base	3500206036	\$2,325	\$2,453	\$2,492
	20 x 72 x 36	Low Profile Base	3500207236	\$2,660	\$2,807	\$2,852
	20 x 84 x 36	Low Profile Base	3500208436	\$3,307	\$3,473	\$3,525
	20 x 96 x 36	Low Profile Base	3500209636	\$3,673	\$3,858	\$3,915
	24 x 60 x 36	Low Profile Base	3500246036	\$2,532	\$2,666	\$2,707
	24 x 72 x 36	Low Profile Base	3500247236	\$2,908	\$3,061	\$3,108
	24 x 84 x 36	Low Profile Base	3500248436	\$3,627	\$3,799	\$3,853
	24 x 96 x 36	Low Profile Base	3500249636	\$4,032	\$4,223	\$4,282



HPL TOPS & CABINET EXTERIOR | 44 standard HPL finishes
 EDGES | matching & coordinating finishes.

TOP EDGE OPTIONS (* Applicable to front edge ONLY)

ABS 1: PVC-free impact resistant flat edge (S)

ABS 2: Multi-Ply "Plywood Look" flat vinyl edge (M)

* ABS 3: Knife (KV), 1/2" Flat edge- bevel painted in a companion color

- Refer to edge code, above in (), when pricing below -

Standard Features:

- Drawers above doors. Adjustable shelf included in each storage area.
- Default 4" Elliptical Door/Drawer Pull (Shown in image above). Other standard pull options below.
- Consult Factory for Premium Pulls, options shown below.
- Adjustable leveling glides included.
- Locking option, and additional options/accessories available, consult factory.

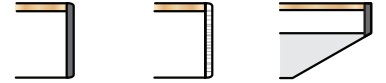

SIZE	BASE INFO #, Style	MODEL #	ABS 1 S	ABS 2 M	ABS 3 KV	
2-DOOR 1-DRAWER CRENZAS - 36" H.						
	20 x 30 x 36	Low Profile Base	3510203036	\$1,514	\$1,594	\$1,619
	20 x 36 x 36	Low Profile Base	3510203636	\$1,717	\$1,807	\$1,834
	24 x 30 x 36	Low Profile Base	3510243036	\$1,619	\$1,705	\$1,732
	24 x 36 x 36	Low Profile Base	3510243636	\$1,832	\$1,928	\$1,958
2-DOOR 2-DRAWER CRENZAS - 36" H.						
	20 x 42 x 36	Low Profile Base	3510204236	\$2,235	\$2,334	\$2,364
	20 x 48 x 36	Low Profile Base	3510204836	\$2,460	\$2,568	\$2,602
	24 x 42 x 36	Low Profile Base	3510244236	\$2,403	\$2,509	\$2,541
	24 x 48 x 36	Low Profile Base	3510244836	\$2,638	\$2,753	\$2,788
4-DOOR 2-DRAWER CRENZAS - 36" H.						
	20 x 60 x 36	Low Profile Base	3510206036	\$2,968	\$3,096	\$3,135
	20 x 72 x 36	Low Profile Base	3510207236	\$3,367	\$3,515	\$3,560
	24 x 60 x 36	Low Profile Base	3510246036	\$3,175	\$3,309	\$3,350
	24 x 72 x 36	Low Profile Base	3510247236	\$3,615	\$3,768	\$3,816
4-DOOR 4-DRAWER CRENZAS - 36" H.						
	20 x 84 x 36	Low Profile Base	3510208436	\$4,449	\$4,616	\$4,667
	20 x 96 x 36	Low Profile Base	3510209636	\$4,901	\$5,087	\$5,144
	24 x 84 x 36	Low Profile Base	3510248436	\$4,769	\$4,942	\$4,995
	24 x 96 x 36	Low Profile Base	3510249636	\$5,260	\$5,452	\$5,511

STANDARD PULL OPTIONS Included in List Price

Elliptical wire (default): approx 4 1/2" long
 Black model #: RFRH1B
 Silver model #: RFRH1S

Double Wire: approx 4 7/8" long
 Black model #: RFRH2B
 Silver model #: RFRH2S

PREMIUM PULL OPTIONS List Price: \$28 ea. (premium upcharge)

Angled Lip Pulls: 8 3/8" long
 Aluminum model #: RFALHA
 Brushed Black model #: RFALHB

Tab Lip Pulls: 8 3/8" long
 Aluminum model #: RFSTPA
 Brushed Black model #: RFSTPB
 White model #: RFSTPW

Rod Style: approx 7" long
 Brushed Nickel model #: RFRSHN
 Matte Black model #: RFRSHB



HPL TOPS & CABINET EXTERIOR | 44 standard HPL finishes

EDGES | matching & coordinating finishes.

TOP EDGE OPTIONS (* Applicable to front edge ONLY)

ABS 1: PVC-free impact resistant flat edge (S)

ABS 2: Multi-Ply "Plywood Look" flat vinyl edge (M)

* ABS 3: Knife (KV), 1/2" Flat edge- bevel painted in a companion color

- Refer to edge code, above in (), when pricing below -

Standard Features:

- Decorative metal legs included. See leg style options on page 195.
- Adjustable shelf included in each storage area.
- Default 4" Elliptical Door Pull. Other standard pull options available. See page 193.
- Consult Factory for Premium Pulls, options shown on page 193.
- Locking option, and additional options/accessories available, consult factory.

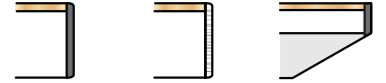

	SIZE	BASE INFO #, Style	MODEL #	Add Leg Style# 1,2 or 3 (ex. 3500203029ML1)	ABS 1 S	ABS 2 M	ABS 3 KV
2-DOOR CRENZAS - 29" H.							
	20 x 30 x 29	(4) Metal Legs	3500203029ML		\$1,201	\$1,281	\$1,306
	20 x 36 x 29	(4) Metal Legs	3500203629ML		\$1,365	\$1,454	\$1,482
	20 x 42 x 29	(4) Metal Legs	3500204229ML		\$1,650	\$1,749	\$1,780
	20 x 48 x 29	(4) Metal Legs	3500204829ML		\$1,826	\$1,935	\$1,968
	24 x 30 x 29	(4) Metal Legs	3500243029ML		\$1,301	\$1,387	\$1,413
	24 x 36 x 29	(4) Metal Legs	3500243629ML		\$1,474	\$1,569	\$1,599
	24 x 42 x 29	(4) Metal Legs	3500244229ML		\$1,813	\$1,918	\$1,951
	24 x 48 x 29	(4) Metal Legs	3500244829ML		\$1,996	\$2,111	\$2,147
2-DOOR CRENZAS - 36" H.							
	20 x 30 x 36	(4) Metal Legs	3500203036ML		\$1,271	\$1,350	\$1,375
	20 x 36 x 36	(4) Metal Legs	3500203636ML		\$1,442	\$1,532	\$1,559
	20 x 42 x 36	(4) Metal Legs	3500204236ML		\$1,742	\$1,841	\$1,872
	20 x 48 x 36	(4) Metal Legs	3500204836ML		\$1,924	\$2,033	\$2,066
	24 x 30 x 36	(4) Metal Legs	3500243036ML		\$1,377	\$1,463	\$1,489
	24 x 36 x 36	(4) Metal Legs	3500243636ML		\$1,557	\$1,653	\$1,683
	24 x 42 x 36	(4) Metal Legs	3500244236ML		\$1,911	\$2,016	\$2,049
	24 x 48 x 36	(4) Metal Legs	3500244836ML		\$2,102	\$2,217	\$2,253
4-DOOR CRENZAS - 29" H.							
	20 x 60 x 29	(6) Metal Legs	3500206029ML		\$2,304	\$2,432	\$2,471
	20 x 72 x 29	(6) Metal Legs	3500207229ML		\$2,624	\$2,771	\$2,816
	20 x 84 x 29	(6) Metal Legs	3500208429ML		\$3,244	\$3,411	\$3,462
	20 x 96 x 29	(6) Metal Legs	3500209629ML		\$3,595	\$3,781	\$3,838
	24 x 60 x 29	(6) Metal Legs	3500246029ML		\$2,498	\$2,632	\$2,673
	24 x 72 x 29	(6) Metal Legs	3500247229ML		\$2,858	\$3,011	\$3,059
	24 x 84 x 29	(6) Metal Legs	3500248429ML		\$3,547	\$3,720	\$3,773
	24 x 96 x 29	(6) Metal Legs	3500249629ML		\$3,939	\$4,130	\$4,189
4-DOOR CRENZAS - 36" H.							
	20 x 60 x 36	(6) Metal Legs	3500206036ML		\$2,443	\$2,571	\$2,610
	20 x 72 x 36	(6) Metal Legs	3500207236ML		\$2,778	\$2,925	\$2,970
	20 x 84 x 36	(6) Metal Legs	3500208436ML		\$3,425	\$3,591	\$3,642
	20 x 96 x 36	(6) Metal Legs	3500209636ML		\$3,791	\$3,976	\$4,033
	24 x 60 x 36	(6) Metal Legs	3500246036ML		\$2,650	\$2,784	\$2,825
	24 x 72 x 36	(6) Metal Legs	3500247236ML		\$3,026	\$3,179	\$3,226
	24 x 84 x 36	(6) Metal Legs	3500248436ML		\$3,745	\$3,917	\$3,970
	24 x 96 x 36	(6) Metal Legs	3500249636ML		\$4,149	\$4,341	\$4,400



HPL TOPS & CABINET EXTERIOR | 44 standard HPL finishes

EDGES | matching & coordinating finishes.

TOP EDGE OPTIONS (* Applicable to front edge ONLY)

ABS 1: PVC-free impact resistant flat edge (S)

ABS 2: Multi-Ply "Plywood Look" flat vinyl edge (M)

* ABS 3: Knife (KV), 1/2" Flat edge- bevel painted in a companion color

- Refer to edge code, above in (), when pricing below -

Standard Features:

- Decorative metal legs included. See leg style options below.
- Drawers above doors. Adjustable shelf included in each storage area.
- Default 4" Elliptical Door/Drawer Pull (Shown in image above). Other pull options on page 193.
- Consult Factory for Premium Pulls, options shown on page 193.
- Locking option, and additional options/accessories available, consult factory.

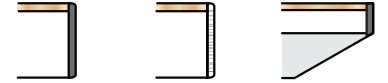

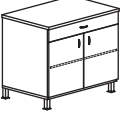
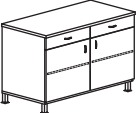
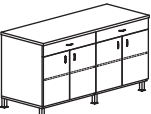
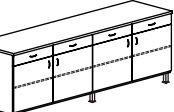
SIZE	BASE INFO #, Style	MODEL #	Add Leg Style# 1, 2 or 3 (ex. 3510203036ML1)	ABS 1 S	ABS 2 M	ABS 3 KV
2-DOOR 1-DRAWER CREDENZAS - 36" H.						
	20 x 30 x 36	(4) Metal Legs	3510203036ML	\$1,593	\$1,673	\$1,697
	20 x 36 x 36	(4) Metal Legs	3510203636ML	\$1,796	\$1,885	\$1,913
	24 x 30 x 36	(4) Metal Legs	3510243036ML	\$1,698	\$1,784	\$1,810
	24 x 36 x 36	(4) Metal Legs	3510243636ML	\$1,911	\$2,007	\$2,036
2-DOOR 2-DRAWER CREDENZAS - 36" H.						
	20 x 42 x 36	(4) Metal Legs	3510204236ML	\$2,313	\$2,412	\$2,443
	20 x 48 x 36	(4) Metal Legs	3510204836ML	\$2,538	\$2,647	\$2,680
	24 x 42 x 36	(4) Metal Legs	3510244236ML	\$2,482	\$2,588	\$2,620
	24 x 48 x 36	(4) Metal Legs	3510244836ML	\$2,717	\$2,832	\$2,867
4-DOOR 2-DRAWER CREDENZAS - 36" H.						
	20 x 60 x 36	(6) Metal Legs	3510206036ML	\$3,047	\$3,174	\$3,214
	20 x 72 x 36	(6) Metal Legs	3510207236ML	\$3,485	\$3,632	\$3,678
	24 x 60 x 36	(6) Metal Legs	3510246036ML	\$3,293	\$3,427	\$3,468
	24 x 72 x 36	(6) Metal Legs	3510247236ML	\$3,733	\$3,886	\$3,934
4-DOOR 4-DRAWER CREDENZAS - 36" H.						
	20 x 84 x 36	(6) Metal Legs	3510208436ML	\$4,567	\$4,733	\$4,785
	20 x 96 x 36	(6) Metal Legs	3510209636ML	\$5,019	\$5,205	\$5,262
	24 x 84 x 36	(6) Metal Legs	3510248436ML	\$4,887	\$5,059	\$5,113
	24 x 96 x 36	(6) Metal Legs	3510249636ML	\$5,378	\$5,570	\$5,629

METAL LEG OPTIONS:

- Select a leg style below, add the suffix 1, 2, or 3 to the model number.
Example: 3510209636ML3 (shown in image, top of the page)
- All legs are approximately 4" - 6" high, +/- 1/2" depending on leg option.
- All leg options are the same price.



L1 - Round Post Contemporary
Silver Aluminum Finish



L2 - Round Contemporary
Silver Aluminum Finish



L3 - Square Contemporary
Silver Aluminum Finish



HPL TOPS & CABINET EXTERIOR | 44 standard HPL finishes

EDGES | matching & coordinating finishes.

ABS 1: PVC-free impact resistant flat edge (S)

ABS 2: Multi-Ply "Plywood Look" flat vinyl edge (M)

- Refer to edge code, above in (), when pricing below -

Standard Features:

- Adjustable shelf included in each storage area.
- Default 4" Elliptical Door Pull (Shown in images above). Other standard pull options available. See below.
- Consult Factory for Premium Pulls, options shown below.
- Locking option, and additional options/accessories available, consult factory.
- Partial back panels in "Refrigerator" and "A/V" consoles for ventilation and access to power outlet on a wall.

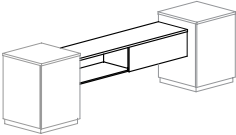
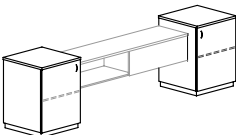
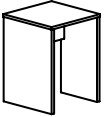
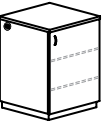

	SIZE	MODEL #	ABS 1 S	ABS 2 M
 <p>CENTER FLOATING STORAGE MODULE</p> <ul style="list-style-type: none"> - 12-1/4"H. (I.D.) - Interior finish is same as exterior. - Sliding door covers one side and keeps opposite side open. - Center module mounted to freestanding "End Consoles" (below), and finishes at 30"H. AFF 	48 x 18 x 15	36004818C	\$1,844	\$1,950
	60 x 18 x 15	36006018C	\$1,925	\$2,050
	72 x 18 x 15	36007218C	\$2,011	\$2,154
 <p>STANDARD END STORAGE CONSOLE</p> <ul style="list-style-type: none"> - Can be ordered as standalone, remove LH or RH from Model# - Must order both LH & RH units when "Center Floating Storage" is desired. 	24 x 24 x 36	36002424ELH	\$1,268	\$1,345
	24 x 24 x 36	36002424ERH	\$1,268	\$1,345
 <p>REFRIGERATOR END CONSOLE</p> <ul style="list-style-type: none"> - Fits most standard under-counter refrigerators. Inside dimensions: approximately 21 1/2" W x 23" D x 34 3/4" H - Specify fridge size when placing order. 	24 x 24 x 36	36002424R	\$1,257	\$1,526
 <p>A/V END CONSOLE</p> <ul style="list-style-type: none"> - Fan on upper right side for ventilation. - Grommet on lower left side for wire management & convection type air flow. - Comes equipped with (2) adjustable shelves with notches at the back to allow for wire management. - In lieu of shelves, interior is large enough to install a rack system for A/V equipment. 	24 x 24 x 36	36002424AVLH	\$1,464	\$1,541
	24 x 24 x 36	36002424AVRH	\$1,464	\$1,541

STANDARD PULL OPTIONS Included in List Price

Elliptical wire (default): approx 4 1/2" long
 Black model #: RFRH1B
 Silver model #: RFRH1S

Double Wire: approx 4 7/8" long
 Black model #: RFRH2B
 Silver model #: RFRH2S

PREMIUM PULL OPTIONS List Price: \$28 ea. (premium upcharge)

Angled Lip Pulls: 8 3/8" long
 Aluminum model #: RFALHA
 Brushed Black model #: RFALHB

Tab Lip Pulls: 8 3/8" long
 Aluminum model #: RFSTPA
 Brushed Black model #: RFSTPB
 White model #: RFSTPW

Rod Style: approx 7" long
 Brushed Nickel model #: RFRSHN
 Matte Black model #: RFRSHB



HPL TOPS & CABINET EXTERIOR | 44 standard HPL finishes

EDGES | matching & coordinating finishes.

ABS 1: PVC-free impact resistant flat edge (S)



ABS 2: Multi-Ply "Plywood Look" flat vinyl edge (M)

- Refer to edge code, above in (), when pricing below -

Standard Features:

- Adjustable leveling glides included, as needed.
- Default 4" Elliptical Door Pull (Shown in images above). Other standard pull options available. See page 196.
- Consult Factory for Premium Pulls, options on page 196.
- (1) Grommet included in the top. Consult factory for other accessories (power, lamp, microphone, etc.).
- Aluminum ledge included to keep paper, pens, etc. from sliding off the slanted top.

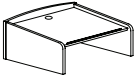

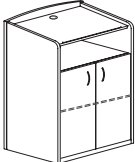
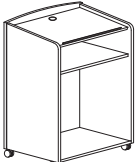
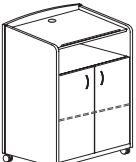
	SIZE	MODEL #	ABS 1 S	ABS 2 M
 TABLE TOP LECTERN	20 x 24 x 13	37002024	\$707	\$942
	20 x 30 x 13	37002030	\$812	\$1,066
 FREESTANDING LECTERN - Fixed shelf, approx. 6" below the top.	20 x 24 x 42	37102024	\$1,500	\$1,890
	20 x 30 x 42	37102030	\$1,821	\$2,214
 FREESTANDING LECTERN WITH DOORS - Fixed shelf, approx. 6" below the top. - Two doors over a storage area, with an adjustable shelf. - Default 4" Elliptical Pulls (other options pg 196) - Consult factory for premium pulls, options on pg 196.	20 x 24 x 42	37202024	\$2,041	\$2,431
	20 x 30 x 42	37202030	\$2,427	\$2,820
 MOBILE LECTERN - Fixed shelf, approx. 6" below the top. - Set of (4) black casters included. NOTE: Lectern height is adjusted to maintain 42" height with added casters	20 x 24 x 42	37152024	\$1,834	\$2,224
	20 x 30 x 42	37152030	\$2,155	\$2,548
 MOBILE LECTERN WITH DOORS - Fixed shelf, approx. 6" below the top. - Two doors over a storage area, with an adjustable shelf. - Default 4" Elliptical Pulls (other options pg 196) - Consult factory for premium pulls, options on pg 196. - Set of (4) black casters included. (specify for hard or soft floors) NOTE: Lectern height is adjusted to maintain 42" height with added casters	20 x 24 x 42	37252024	\$2,139	\$2,529
	20 x 30 x 42	37252030	\$2,525	\$2,918

CARTS | STANDS



HPL TOPS & CABINET EXTERIOR | 44 standard HPL finishes

EDGES | matching & coordinating finishes.

ABS 1: PVC-free impact resistant flat edge (S)



ABS 2: Multi-Ply "Plywood Look" flat vinyl edge (M)

- Refer to edge code, above in (), when pricing below -

Standard Features:

- Adjustable shelf included in each storage area.
- Default 4" Elliptical Door Pull (Shown in images above). Other standard pull options available. See below.
- Consult Factory for Premium Pulls, options below.
- Lock Included with Serving Carts. Consult factory for locking option with Phone Stands.

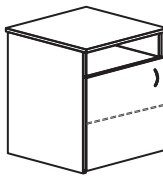
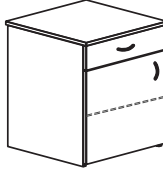

	SIZE	MODEL #	ABS 1 S	ABS 2 M
 <p>MOBILE SERVING CART WITH OPEN SHELF</p> <ul style="list-style-type: none"> - Rod style bars included on each side of cabinet for steering. - Black dual wheel locking casters included. - Fixed shelf, approx. 6" below the top. - Specify casters for hard or soft floors. 	20 x 30 x 36	38002030	\$2,335	\$2,415
	20 x 36 x 36	38002036	\$2,538	\$2,628
 <p>MOBILE SERVING CART WITH DRAWER</p> <ul style="list-style-type: none"> - Rod style bars included on each side of cabinet for steering. - Black dual wheel locking casters included. - 6" Utility drawer above doors. - Specify casters for hard or soft floors. 	20 x 30 x 36	38102030	\$2,335	\$2,415
	20 x 36 x 36	38102036	\$2,538	\$2,628
 <p>PHONE STAND WITH OPEN SHELF</p> <ul style="list-style-type: none"> - Fixed shelf, approx. 6" below the top. - Adjustable leveling glides included. 	20 x 20 x 30	39002020	\$1,244	\$1,308
	20 x 24 x 30	39002024	\$1,290	\$1,360
 <p>PHONE STAND WITH DRAWER</p> <ul style="list-style-type: none"> - 6" Utility drawer above doors. - Adjustable leveling glides included. 	20 x 20 x 30	39102020	\$1,244	\$1,308
	20 x 24 x 30	39102024	\$1,290	\$1,360

STANDARD PULL OPTIONS Included in List Price

Elliptical wire (default): approx 4 1/2" long
 Black model #: RFRH1B
 Silver model #: RFRH1S

Double Wire: approx 4 7/8" long
 Black model #: RFRH2B
 Silver model #: RFRH2S

PREMIUM PULL OPTIONS List Price: \$28 ea. (premium upcharge)

Angled Lip Pulls: 8 3/8" long
 Aluminum model #: RFALHA
 Brushed Black model #: RFALHB

Tab Lip Pulls: 8 3/8" long
 Aluminum model #: RFSTPA
 Brushed Black model #: RFSTPB
 White model #: RFSTPW

Rod Style: approx 7" long
 Brushed Nickel model #: RFRSHN
 Matte Black model #: RFRSHB